

IEEE P1722 AVBTP Encapsulations

Version 0.11, 2007-12-09

Alan K. Bartky alan@bartky.net

Bartky Networks www.bartky.net

Send comments to AVBTP@listserv.ieee.org

Notice of copyright release

- **Notice:**

- This document has been prepared to assist the work of the IEEE P1722 and IEEE 802 Working Groups. It is offered as a basis for discussion and is not binding on the contributing individual(s) or organization(s). The material in this document is subject to change in form and content after further study. The contributor(s) reserve(s) the right to add, amend or withdraw material contained herein.

- **Copyright Release to IEEE:**

- The contributor grants a free, irrevocable license to the IEEE to incorporate material contained in this contribution, and any modifications thereof, in the creation of an IEEE Standards publication; to copyright in the IEEE's name any IEEE Standards publication even though it may include portions of this contribution; and at the IEEE's sole discretion to permit others to reproduce in whole or in part the resulting IEEE Standards publication. The contributor also acknowledges and accepts that this contribution may be made public by the IEEE P1722 Working Group or the IEEE 802 Working Group.

Revision History

Rev	Date	Comments
0.01	2007-06-24	First version using formats and notes based on what probably will start going into the draft P1722 specifications.
0.02	2007-06-27	Added draft proposal for fragmentation for discussion on how to handle large CIP packets broken up into smaller packets for the case of 1394/61883 to AVBTP /61883 interworking. Cleaned up some diagrams to correct areas “grey” or white depending on scope of fields versus the diagram (what the diagram was trying to convey as fields of interest).
0.03	2007-07-02	Changed proposed Proprietary/Experimental based on feedback from John Nels Fuller on 2007-07-02 teleconference
0.04	2007-08-08	Changed frame formats and updated diagrams to: <ul style="list-style-type: none">•Accommodate latest fragmentation/reassembly proposal (Alan Bartky)•Accommodate for latest “cross timestamp” control frame proposal (Chuck Harrison)•Prepare for draft 0.03 of the P1722 specification.•Updated proposal for “escape type” protocol to accommodate new proposal for standardized fragmentation/reassembly and packet length at “standard” places. Removed detailed description of fields (see draft 0.02 or upcoming 0.03 P1722 specification for those details) except for the new proposal for fragmentation/reassembly .
0.05	2007-08-09	Misc cleanup, fixes and also added Chuck Harrison’s Cross Timestamping encapsulations.

Revision History (continued)

Rev	Date	Comments
0.06	2007-08-09	Continuing misc. edits (using this presentation for source of master diagrams for P1722 specification)
0.07	2007-10-04	<p>Incorporated encapsulation changes as discussed at last face to face meeting and teleconferences afterwards up to the present date (2007-10-04).</p> <ul style="list-style-type: none">•Added 64 bit stream ID field to all AVBTP immediately following the Ethertype-Subtype quadlet.•Added 1 bit Control/Data Field in the 8 bit subtype field and changed the subtype to a 7 bit field. Adjusted values accordingly in the sub-type field as well.•Changed all text within the diagrams to a consistent 12 point Arial font.•Removed diagram showing Intermediate fragment as my understanding of consensus is at least for 61883 over AVBTP, we will always put in the 1394-like and CIP header into each and every fragment such that the sample data is always at the same offset for each fragment.
0.08	2007-11-04	<ul style="list-style-type: none">•Per agreement from Santa Clara face to face meeting, changed all formats to be on the same 32 bit alignment as IP packets.<ul style="list-style-type: none">•Re-drew MAC headers/frame format on separate diagram and removed MAC headers from all AVBTP frame diagrams. Used 16 bit based diagrams for 802.3 and 32 bit for all AVBTP frames. Showed all indexes based on 0 being 1st quadlet of the AVBTP frame.•Added initial proposal for place for the new 8 bit field for tracking GM changes proposed by Matt Mora and meeting with general approval so far in email.•Added new Editor's proposal for adding a common length field for all control packets

Revision History (continued)

Rev	Date	Comments
0.09	2007-11-27	<ul style="list-style-type: none">•Added in John Fuller's AV/C diagrams and adapted to new format to align to same quadlet alignment as IP packets.•Reduced control length field from 16 bits to 11 bits (still accommodates max size Ethernet frame and allows 5 additional bits for other use)•Added proposed 5 bit status field to all control packets (used to carry most status information from John's proposal as well)•Misc. cleanup•Changed text on multiple slides from "packet" to "frame" (as convention in latest draft is "packets" are to/from the layer above AVBTP and frames are to/from lower layers.
0.10	2007-11-29	<ul style="list-style-type: none">•Changed diagram for 64 bit stream ID field to match method used in 1394TA documents for 64 bit fields.•Added backup/misc. section in the back for misc. editor's cut and paste into P1722 draft.•Got rid of all 0x... (C convention) constants and changed to ...₁₆ (IEEE spec convention)•Updated Command Transport frames based on email 2007-11-29 from John Fuller

Revision History (continued)

Rev	Date	Comments
0.11	2007-12-09	<ul style="list-style-type: none">•Updated per design discussions/comments from Fremont CA face to face meeting<ul style="list-style-type: none">•Added packet header length field (per John Nel's Fuller's suggestion)•For Stream data frame, changed stream_reserved to stream_reserved1 and subtype_data2 to stream_reserved2•Changed all occurrences of octet to byte•Renamed misc. fields for clarity

Encapsulation Design Assumptions

- AVBTP shall use 802.1AS for time base
- AVBTP shall be able to react to change in 802.1AS time (user changing time of day, change in Grandmaster, etc. (see 802.1AS assumptions from AVB document)).
- 61883 format over AVBTP will support presentation time using AVBTP timestamp field instead of current 61883 SYT field
 - 1394/61883 to 1722/61883 gateways will have to take care of all SYT to AVBTP timestamp conversions, synchronization, cross timestamps, etc.
 - Editor's note: Need to work out SYT field for SPH = 1 packets as timestamps are on a per source packet basis (MPEG packet) instead of in the CIP header.
- AVBTP 61883 presentation time shall be relative to the 802.1AS clock
- Adapt 1394 AV/C Function Control Protocol (FCP) for use in 61883 over AVBTP.
- Proprietary encapsulations allowed via reserved subtype ($7F_{16}$)
- Allow for other future expansions via different subtypes.

Encapsulation Assumptions

- All AVBTP packets shall contain a 64 bit 802.1Qat Stream ID field. That field shall be used for stream identification.
 - TBD: Relationship with source and destination MAC address.
 - TBD: Need to have a standard value that indicates that stream ID contains no data (perhaps all zeros or all ones?)
 - >>Editor prefers all zeros to avoid confusion with Broadcast MAC address of FF-FF-FF-FF-FF-FF.
- For AVBTP stream data and control frames, MAC Destination Address may be unicast, multicast or broadcast depending on the specification of the usage of each AVBTP control frame.

Encapsulation Assumptions

- All talkers shall always send stream data frames with 1st Ethertype field set to 8100_{16} for 802.1 P/Q type.
- For AVBTP, talkers and controllers are not required to send stream control frames with an 802.1 P/Q tag.
- All AVBTP compliant devices must always be able to accept data and control frames with an 802.1 P/Q tag.

Encapsulation Assumptions

- VLAN Identifier (VID), 12 bits:
 - The VID is a VLAN and not a Stream Identifier
 - AVBTP stations must support VLAN ID of zero to send or receive for stream data traffic.
 - AVBTP stations are recommended to support other VLAN IDs, but it is not required.
 - Receiving AVBTP stations shall ignore the VLAN ID field (i.e. they will assume that if they receive frames, then they are a member of that VLAN).
- Canonical Format Indicator (CFI), 1 bit
 - AVBTP will only support CFI of zero.
- Priority Code Point (PCP), 3 bits:
 - For data streams, AVBTP talkers shall always use the appropriate value (default or as administered to a different value) for IEEE 802.1Qav class A or class B traffic.
 - >> Editor's note: Would actually prefer that we get a confirmation that 802.1Qat will tell us the value to use, and then we can just point to that standard.

AVBTP 802.3 with 802.1Q Tag field MAC frame

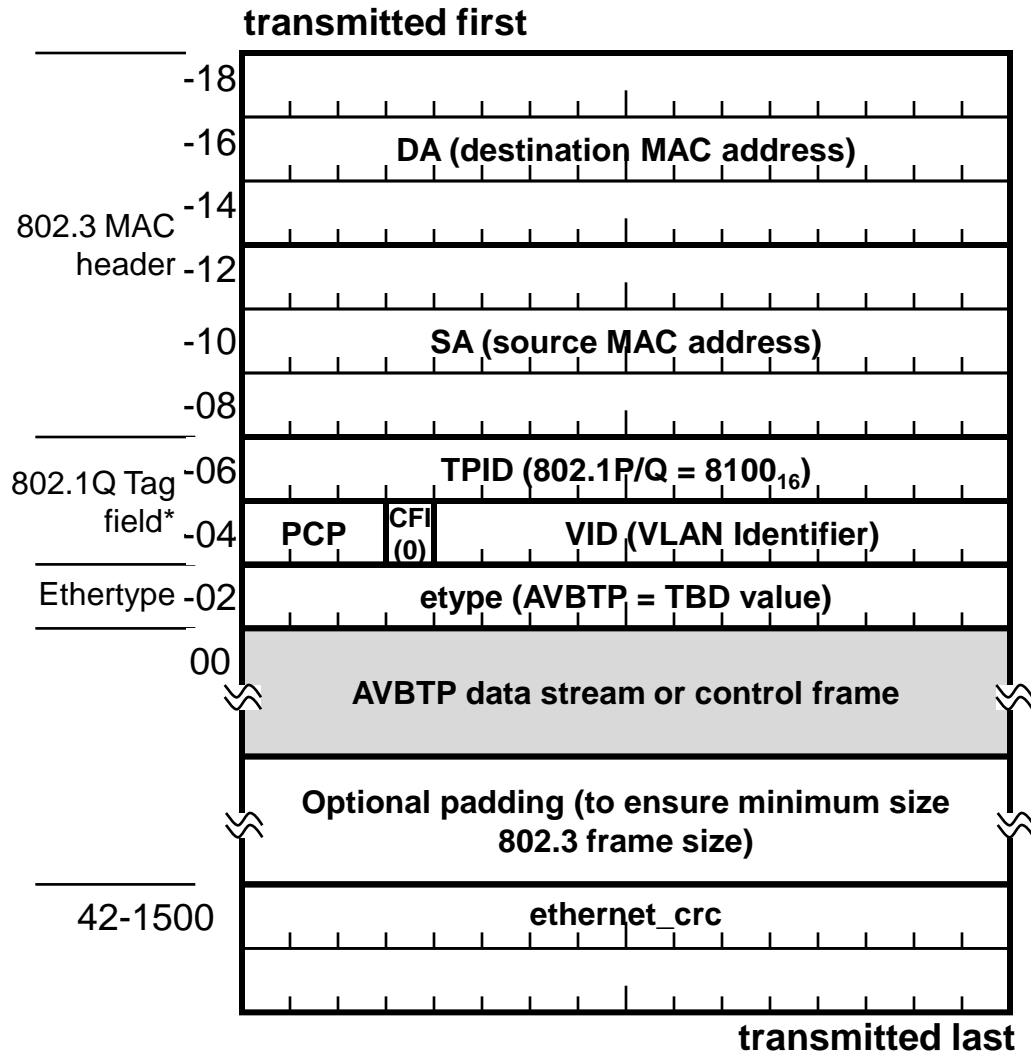

Note: AVBTP data stream frames must always use this format. AVBTP control frames may use this format on transmit. All AVBTP devices must be able to receive data or control frames in this format.

AVBTP 802.3 without 802.1Q Tag field MAC frame

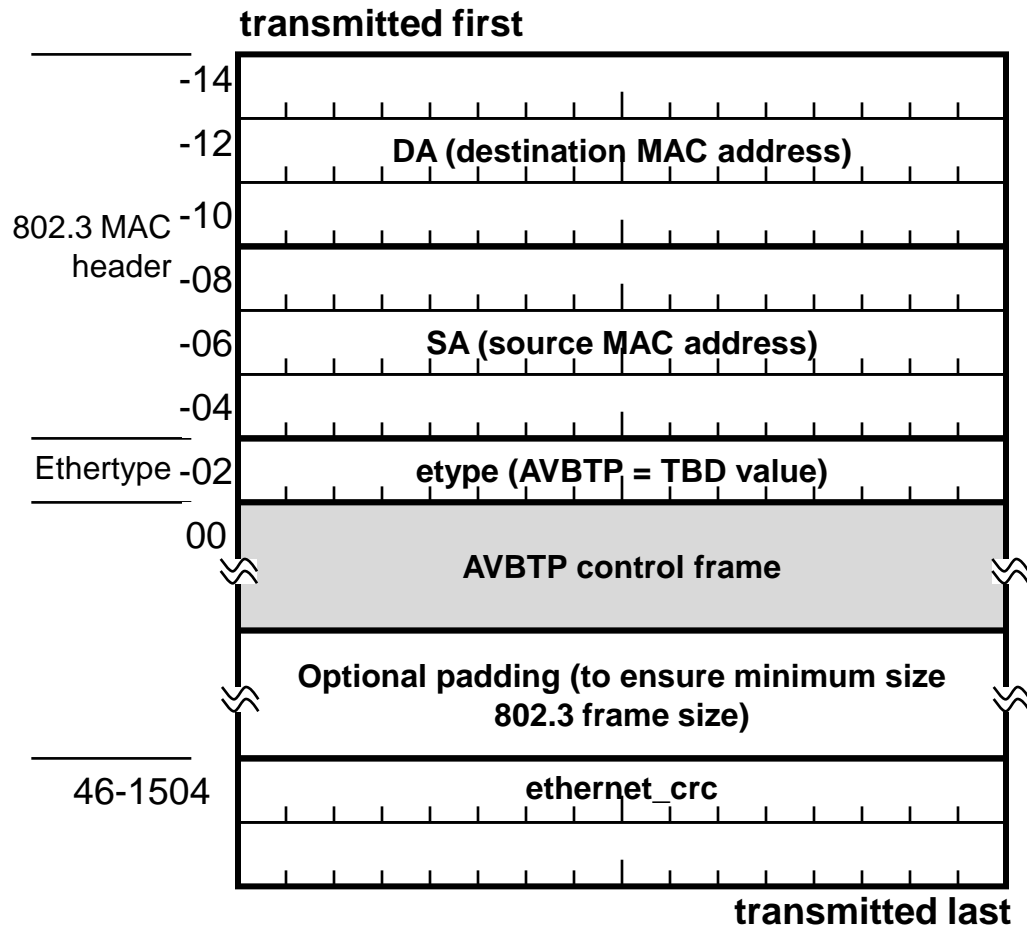

Note: Only AVBTP control frames may use this format, data frames must have 802.1Q tag field

AVBTP frame common fields

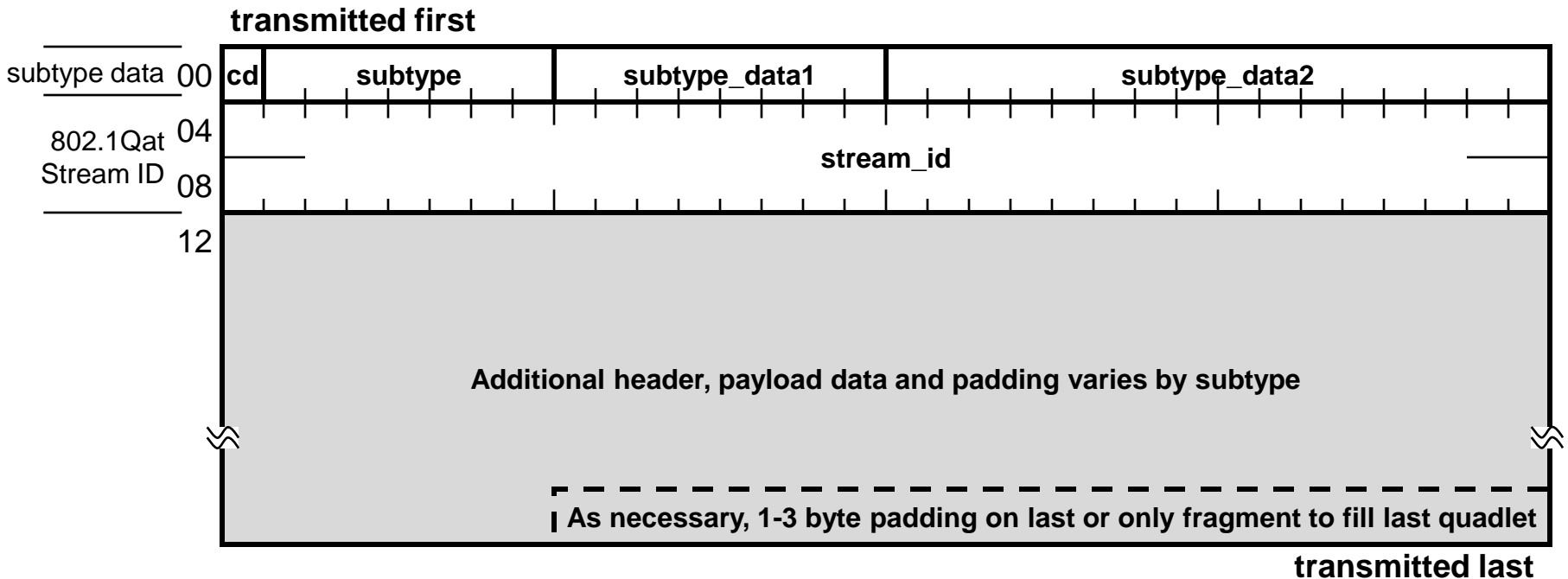

Control frame common header

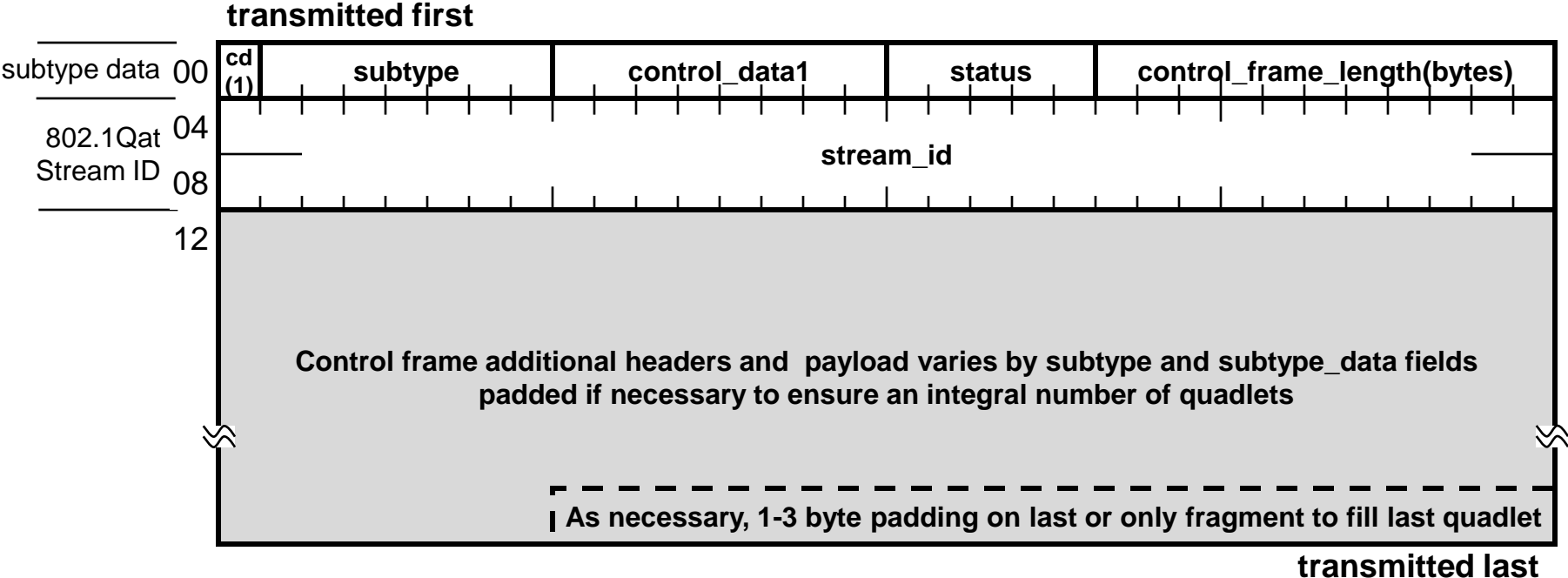

AVBTP stream type data frame, general

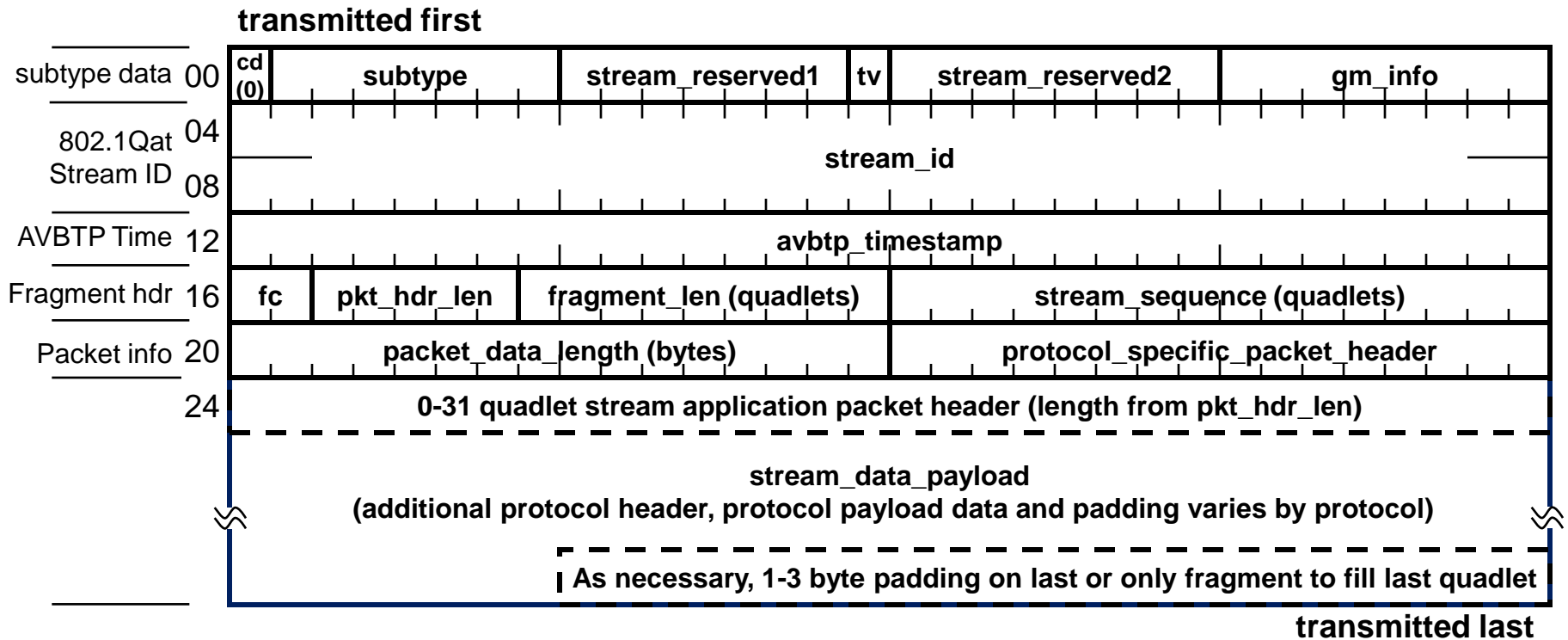

Fragmentation, sequence, length stream fields

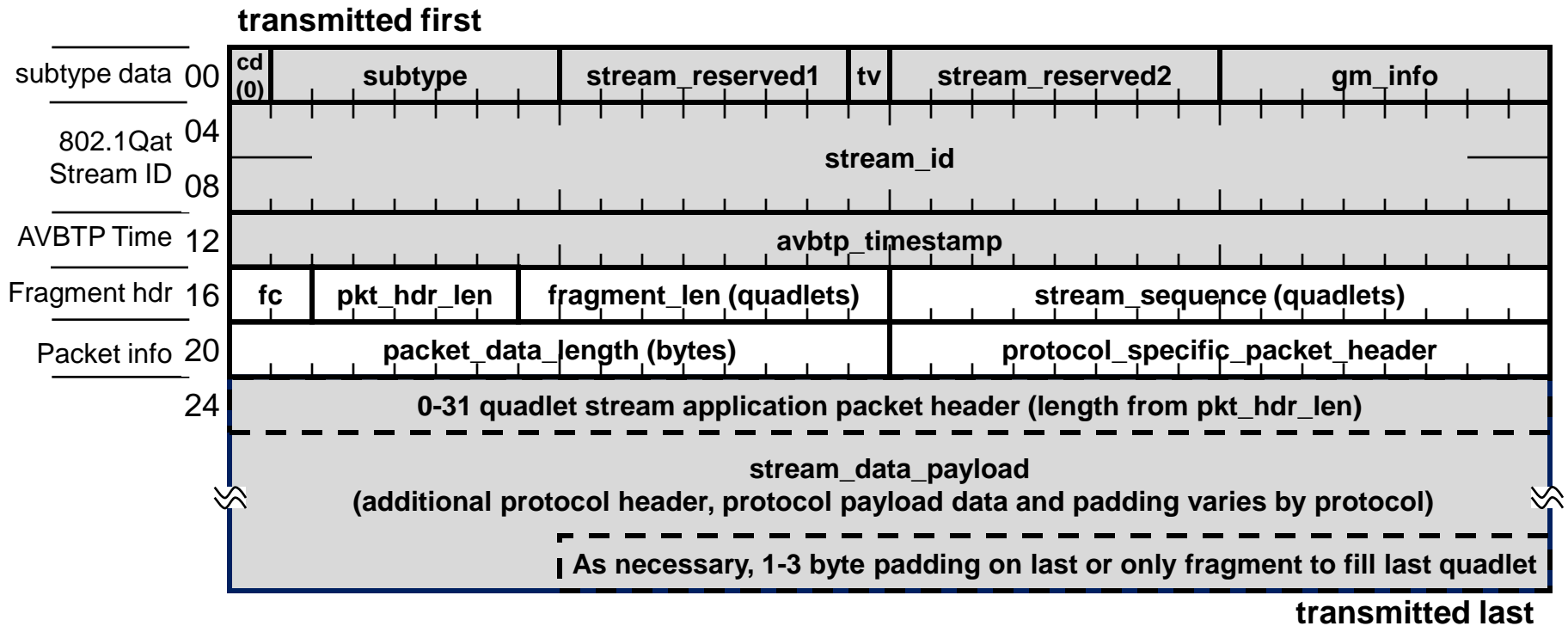

Draft AVBTP Subtype 0, 61883/IIDC data packet

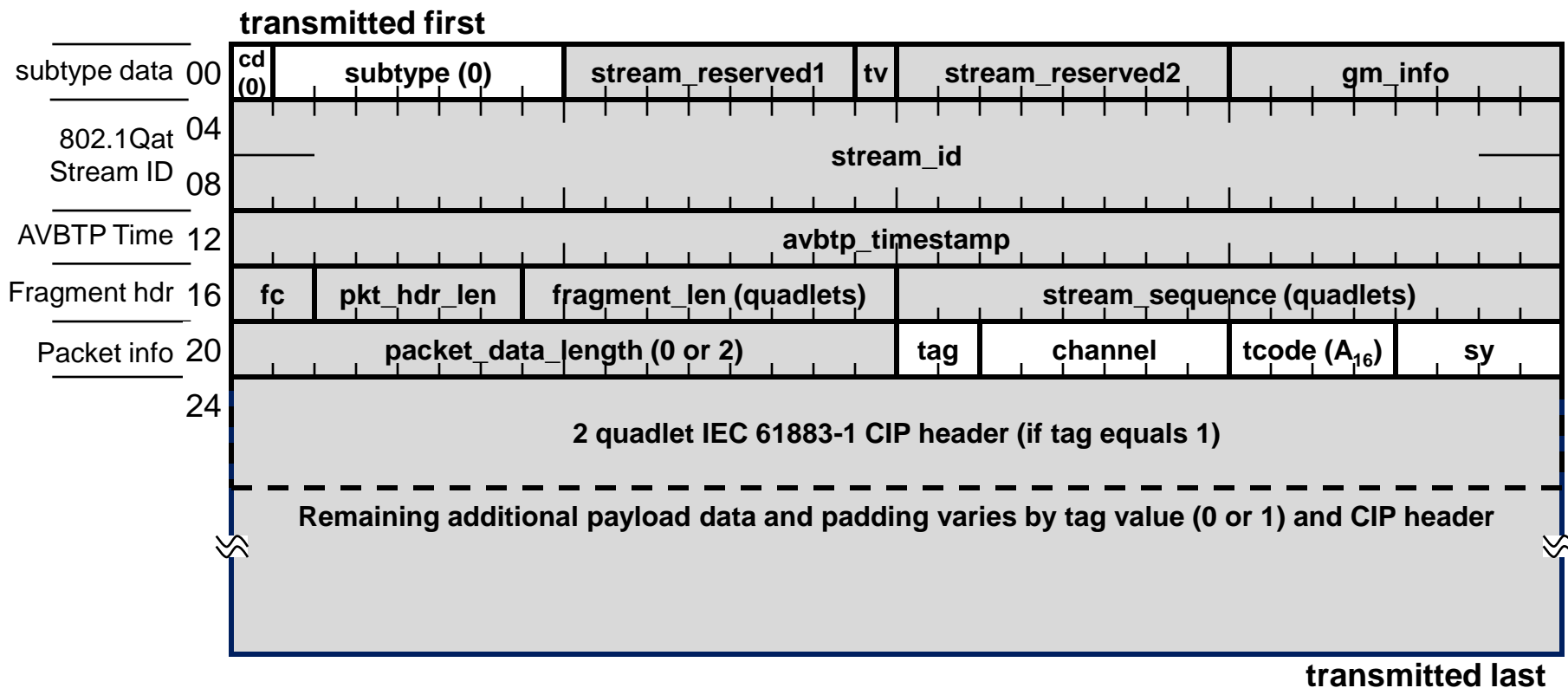

Draft AVBTP IIDC Stream Data packet

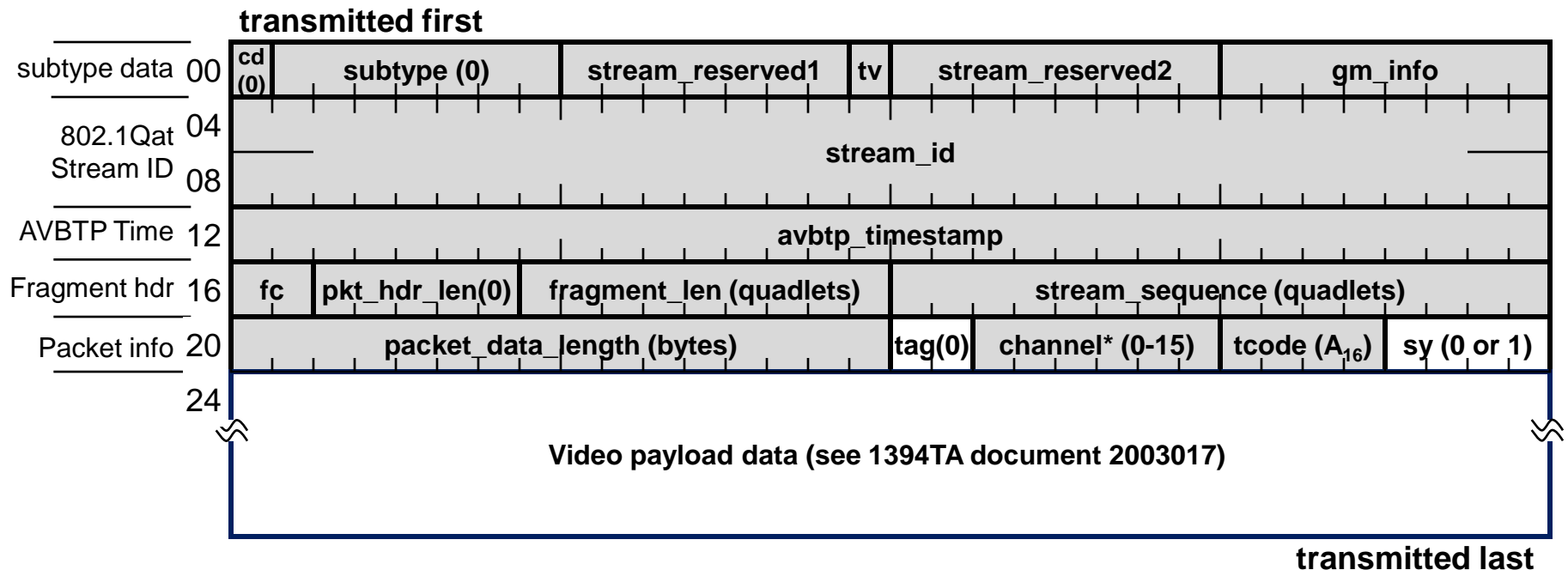

***Note: Current standard for IIDC restricts channel ID to 0-15**

Draft AVBTP CIP Stream Data packet, SPH(0)

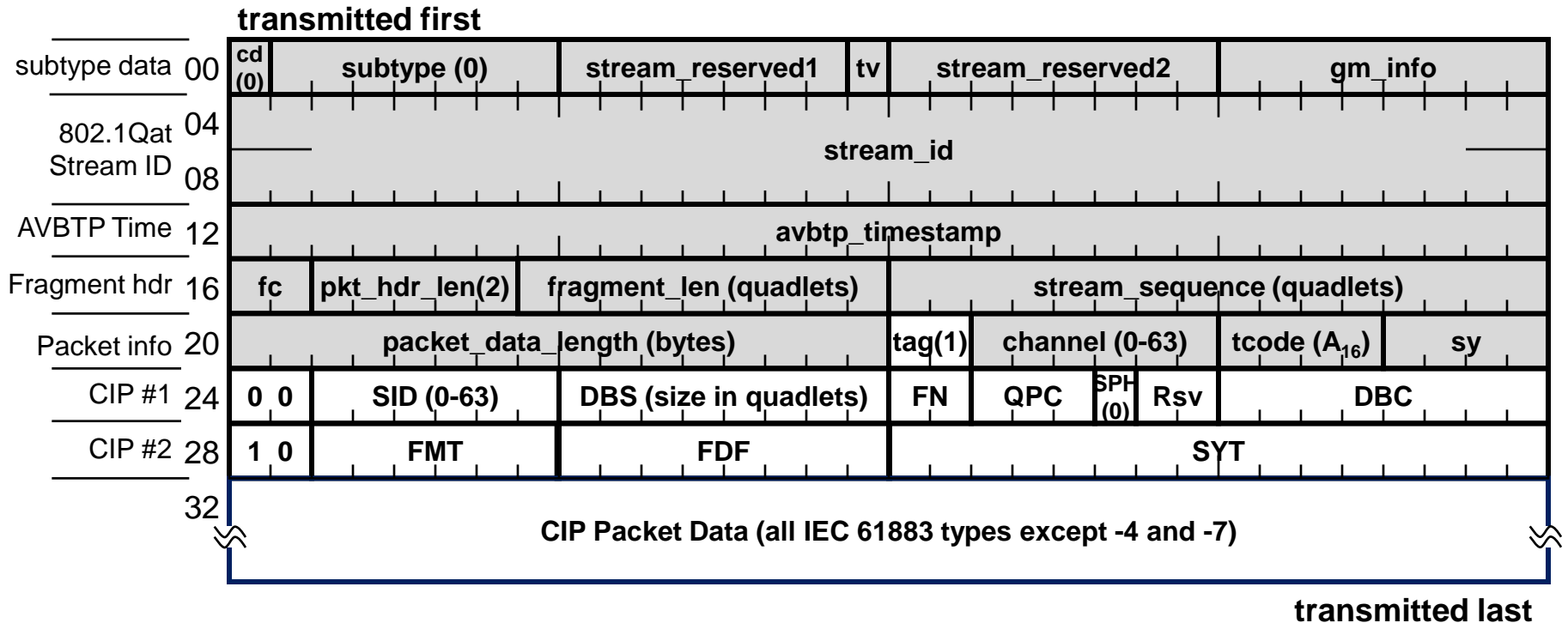

Draft AVBTP CIP Stream Data packet, SPH(1)

transmitted first

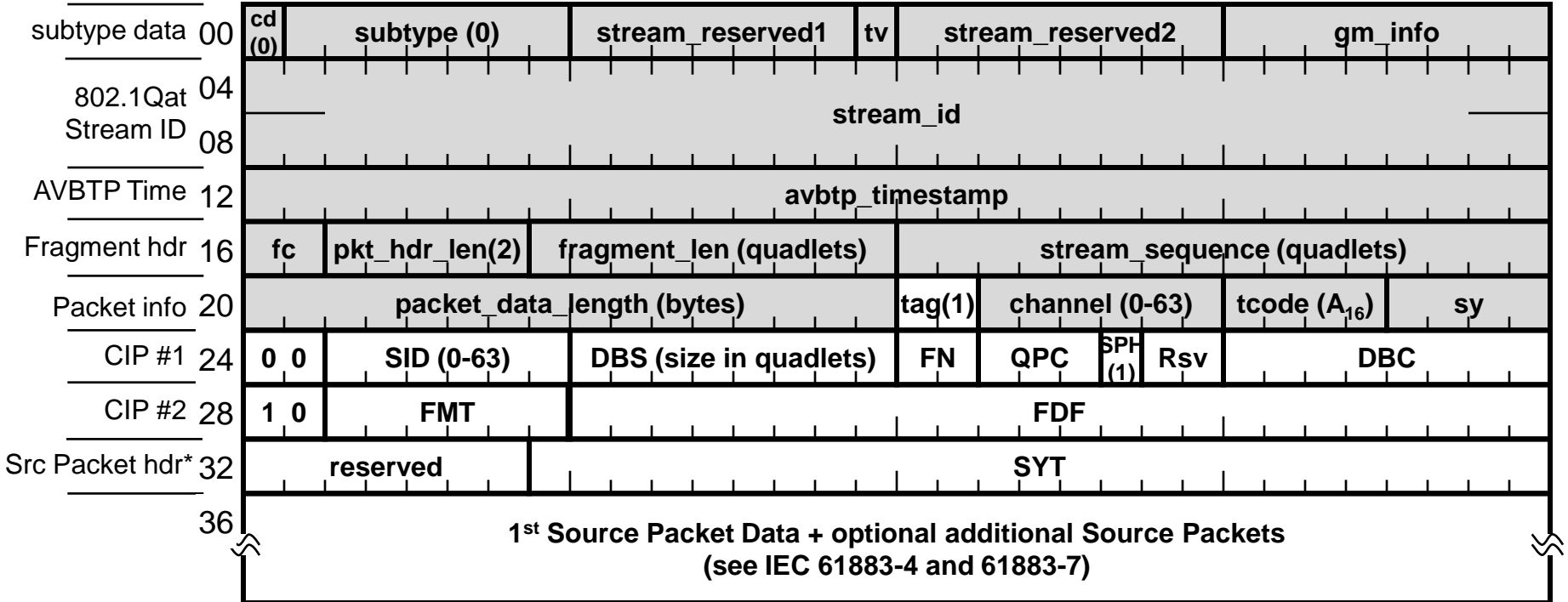

transmitted last

Command Transport Protocol (CTP) frame

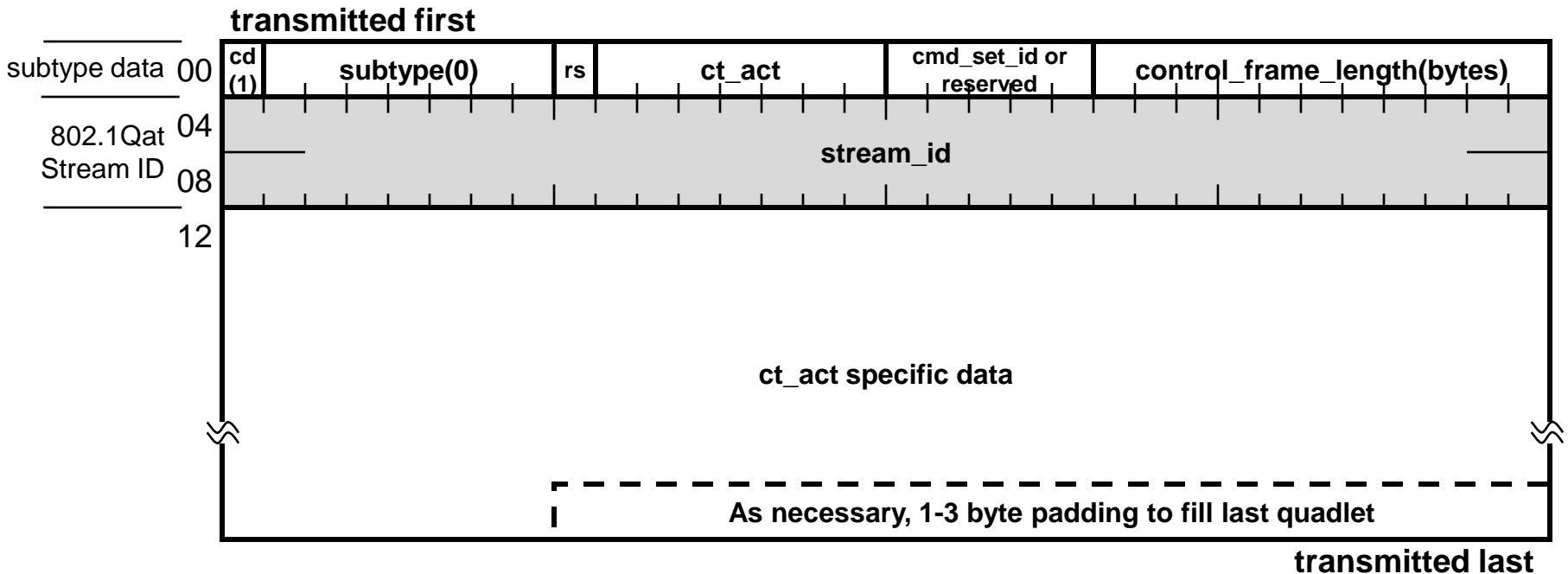

Login (CTP) frames

Action:

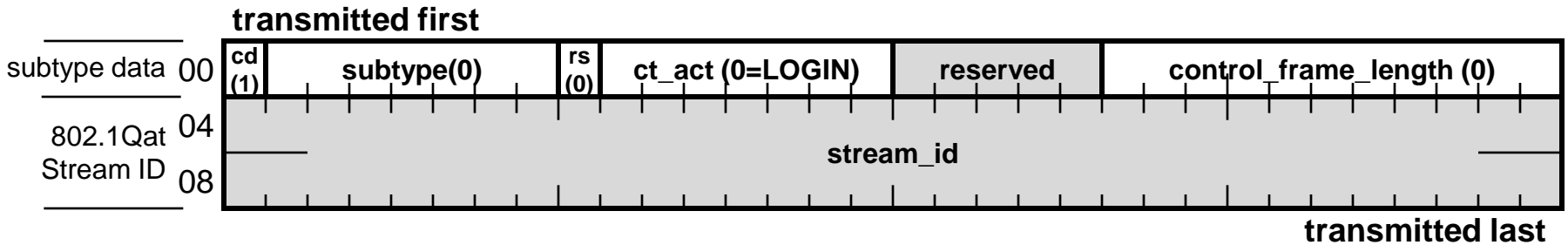

Response:

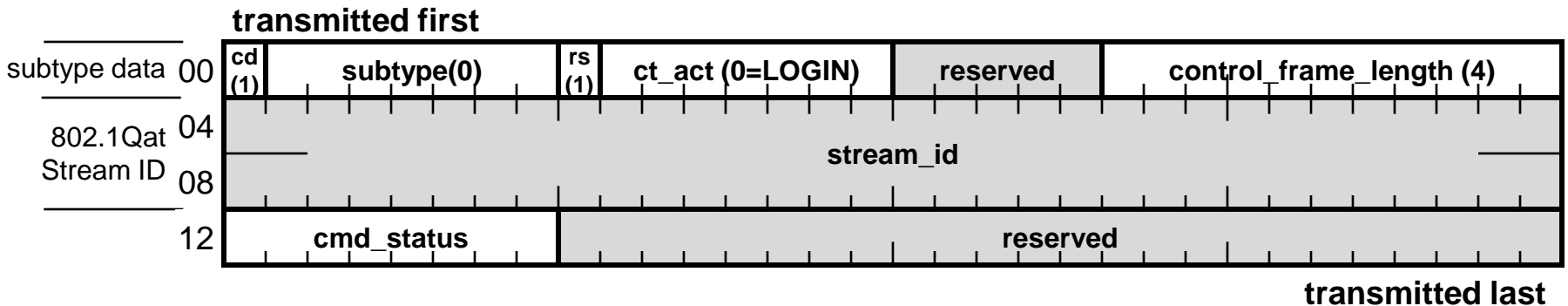

Logout (CTP) frames

Action:

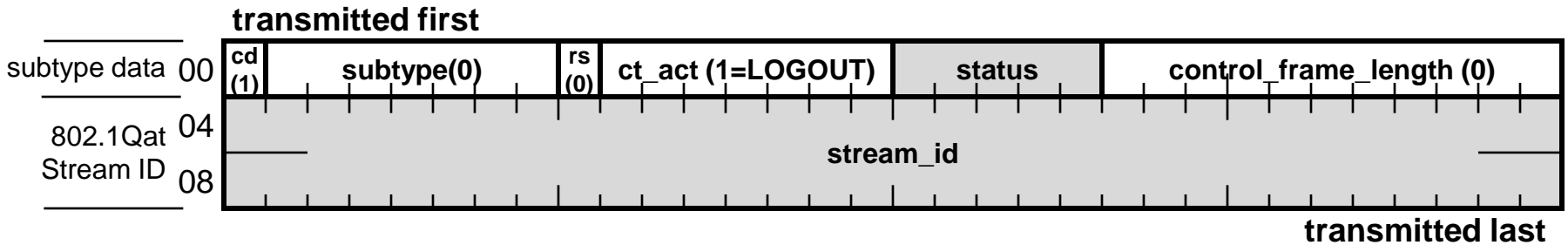

Response:

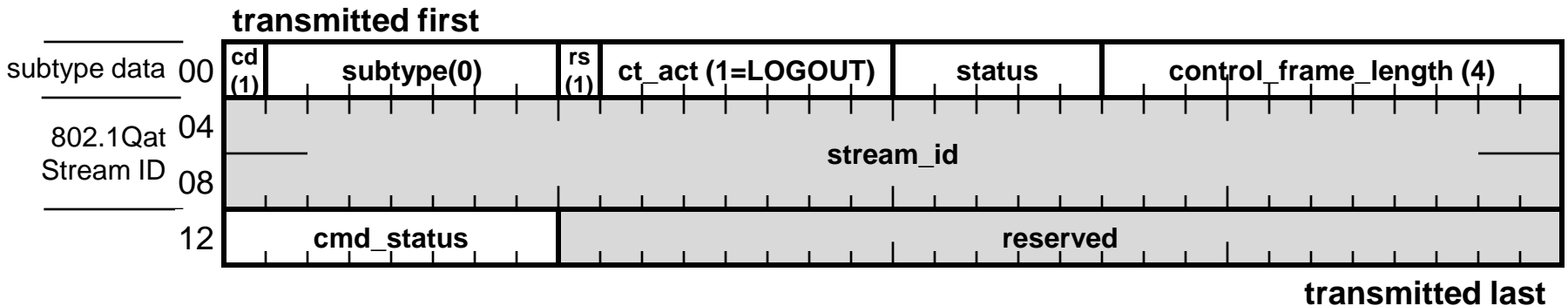

Sequence Number Reset (CTP) frames

Action:

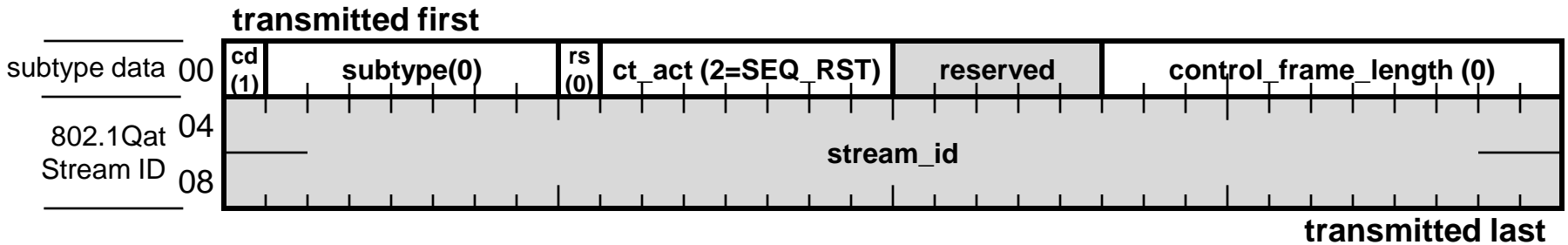

Response:

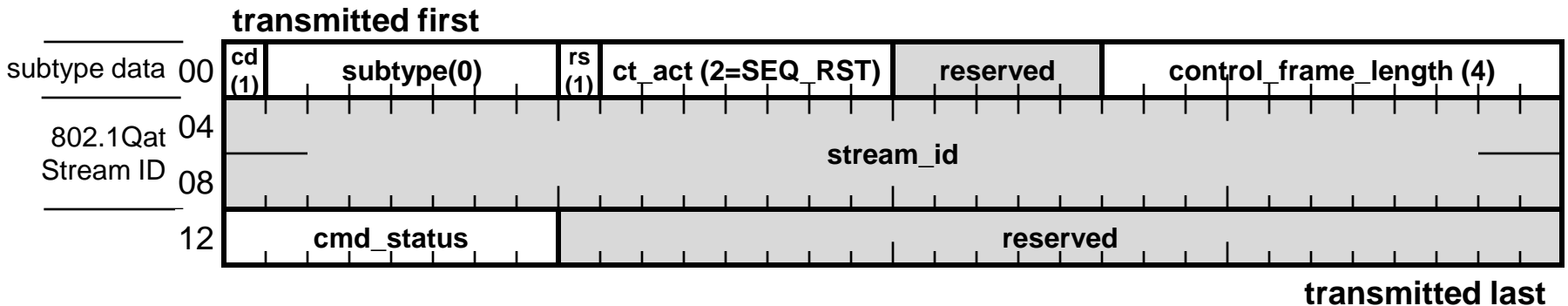

Execute Action (CTP) frames

Action:

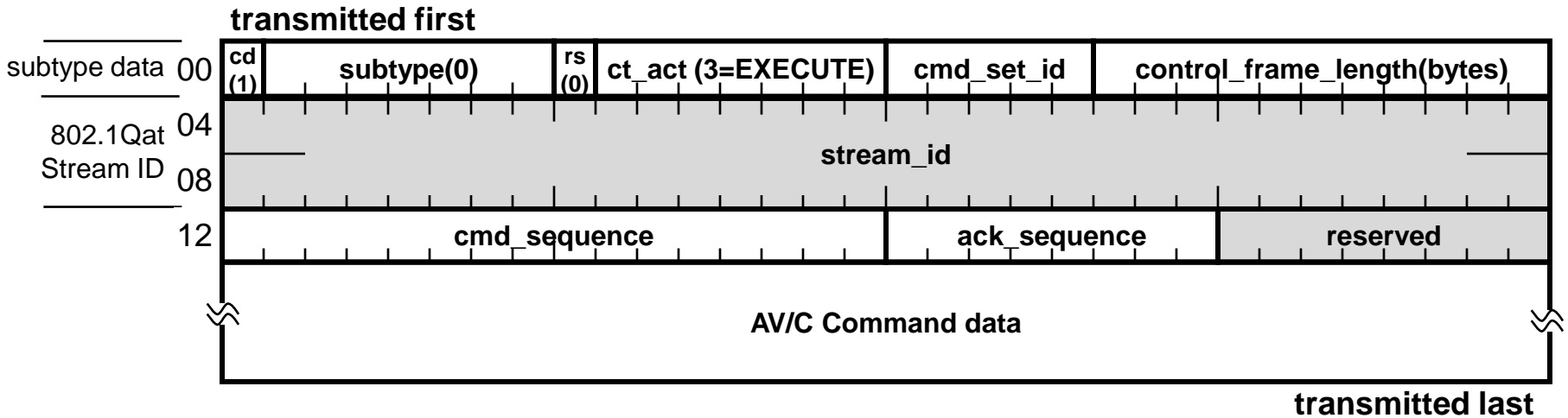

Response:

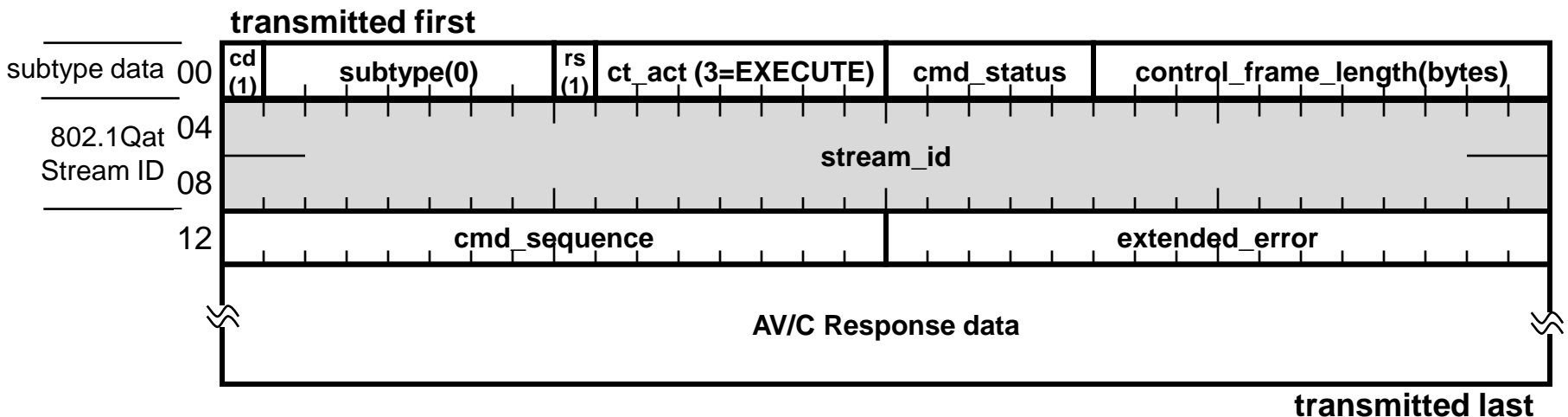

AVBTP Proprietary/Experimental Stream Data format

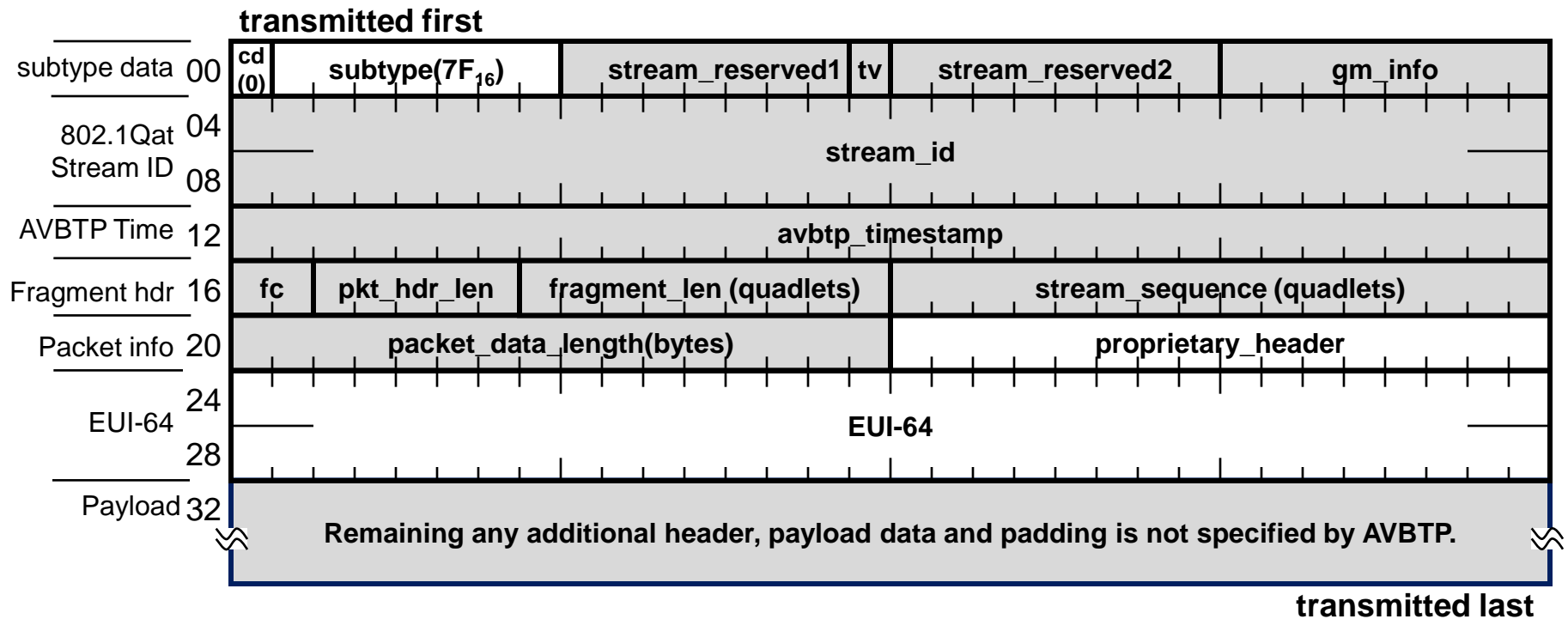

December 9, 2007

Bartky Networks www.bartky.net

Contribution

AVBTP Proprietary/Experimental control format

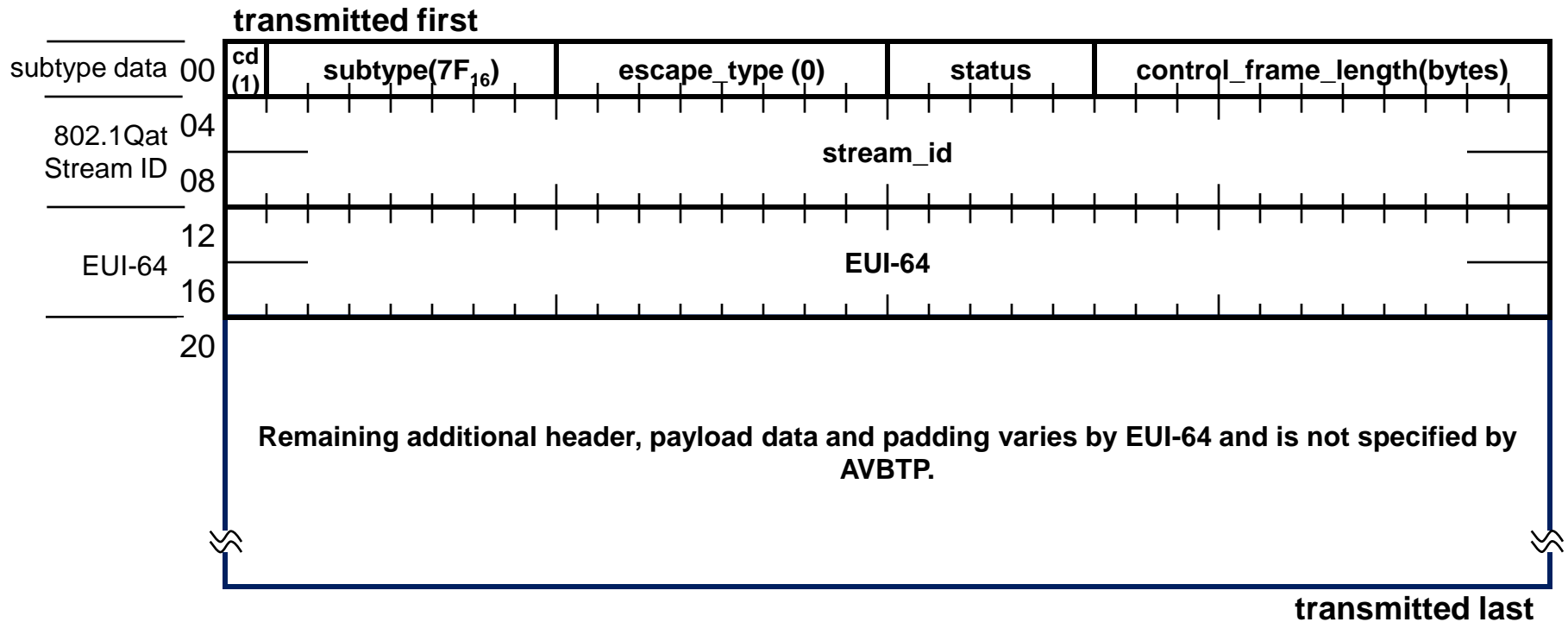

Cross Timestamp (XTS) frame

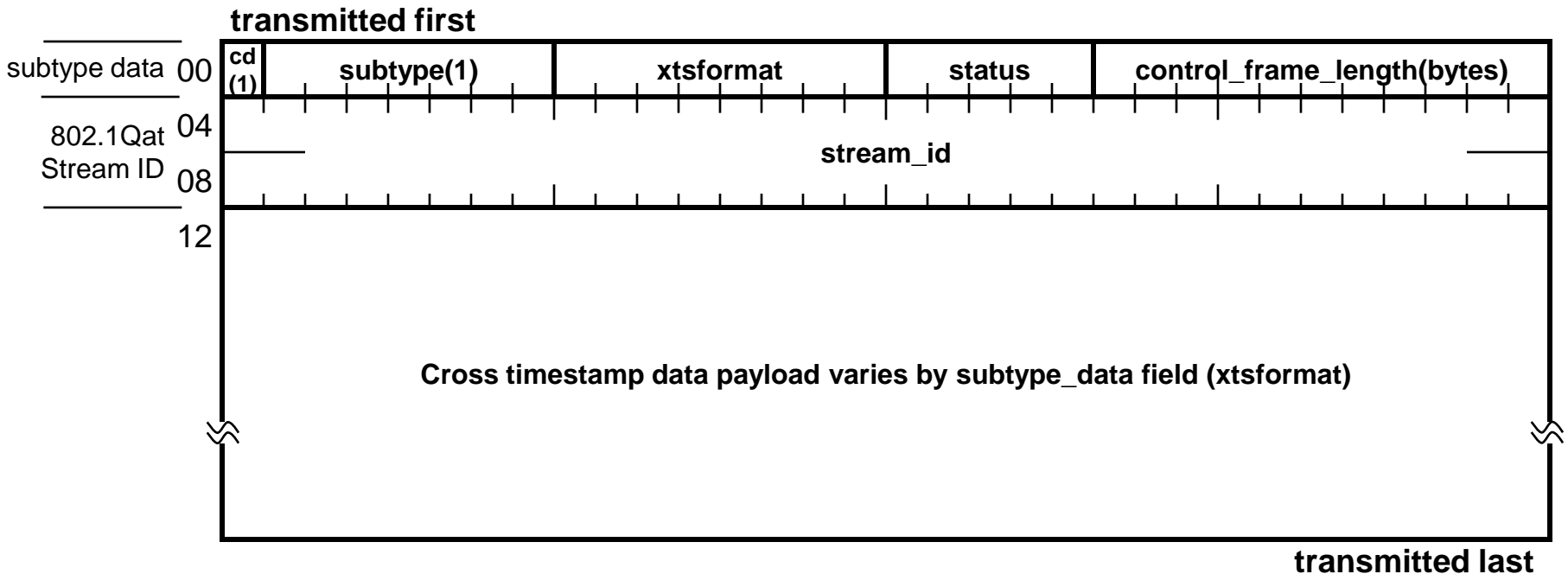

Full SYT format XTS frame

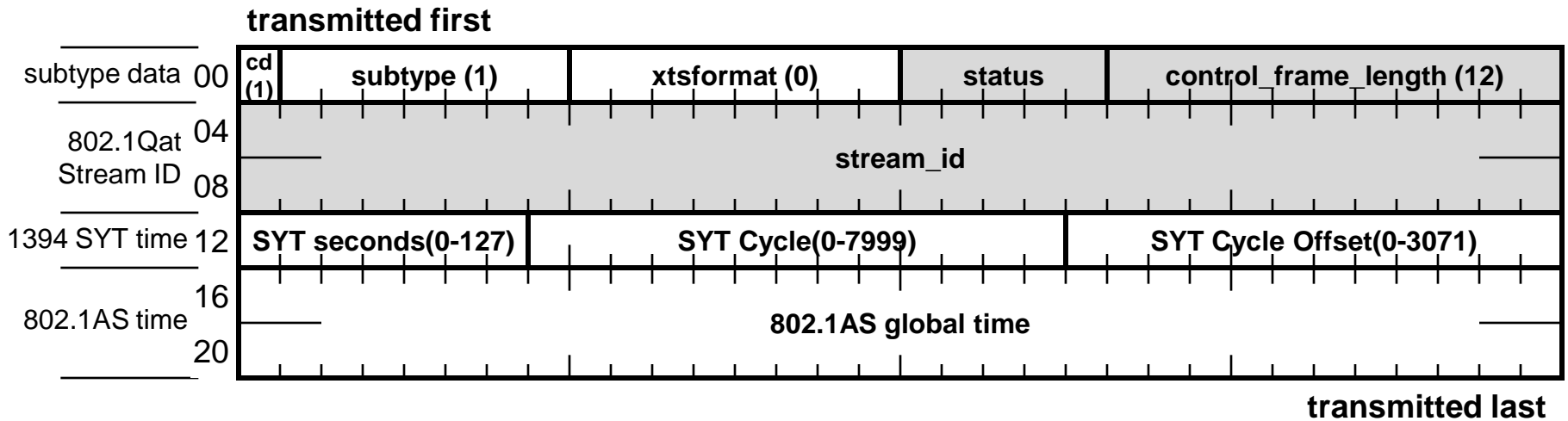

Update SYT format XTS frame

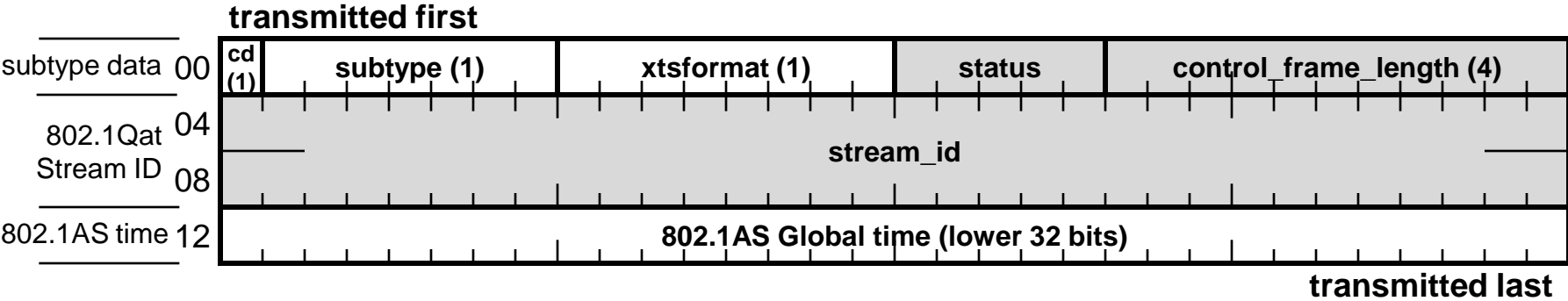

Generic format XTS frame

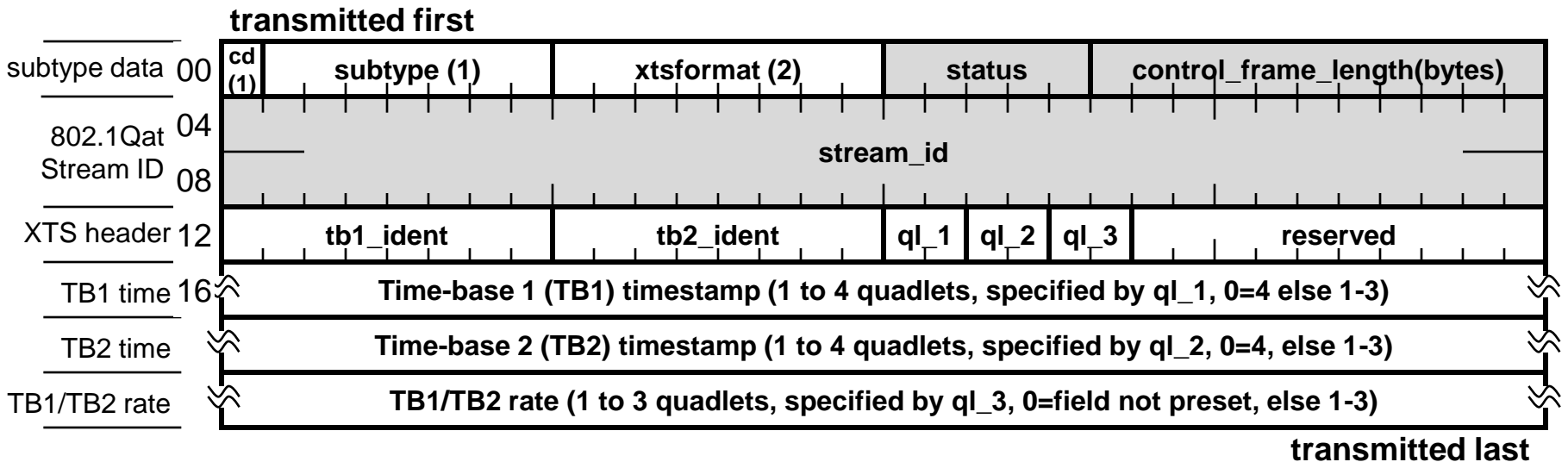

Backup and misc.

Editor's placeholder for misc. other data, diagrams, etc.

transmitted first

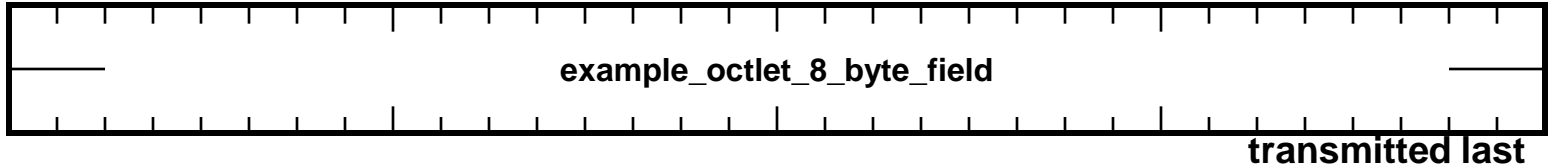

transmitted first

