



Semiconductor Optical Amplifiers for Passive Optical Networks

Leo Spiekman, David Piehler
Alphion Corp.

Expanding the PON link budget

Toolkit:

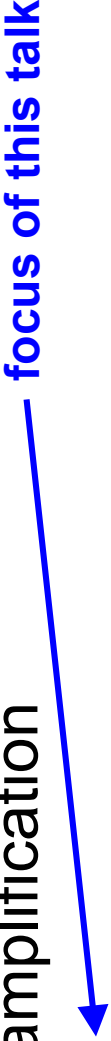
- Transmitter optical power / dispersion tolerance
 - Direct modulation, external modulation
- Receiver sensitivity
 - PIN, APD
- FEC
- Optical amplification
 - SOAs 
 - EDFAs (and other fiber amplifiers)
 - Raman Amplifiers

EDFAs vs. SOAs for PONs

- Ubiquitous in optical communications
- High output power
- Only operates in the 1550 nm band
- Based on ubiquitous InP telecom technology
- Lower output power
- Operates at all telco laser wavelengths

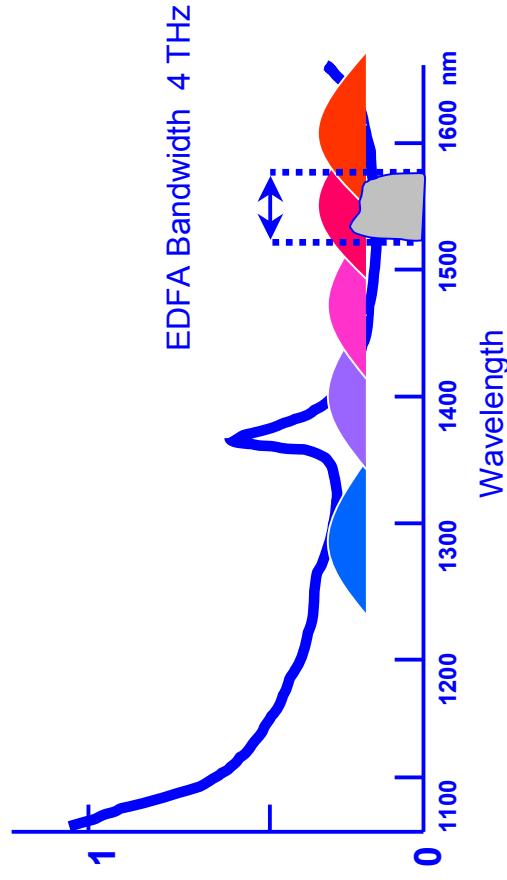

Semiconductor Optical Amplifier

Mature technology:

- Chip is essentially an anti-reflection coated FP laser
- Industry standard butterfly packaging
- Cost comparable to EDFA pump laser

Key advantage:

- Amplification at any desired λ in range 1200 ... 1650 nm
- Covers all wavelengths used in PON and CWDM
- Each amplifier has ~80 nm BW
- Economies of integration

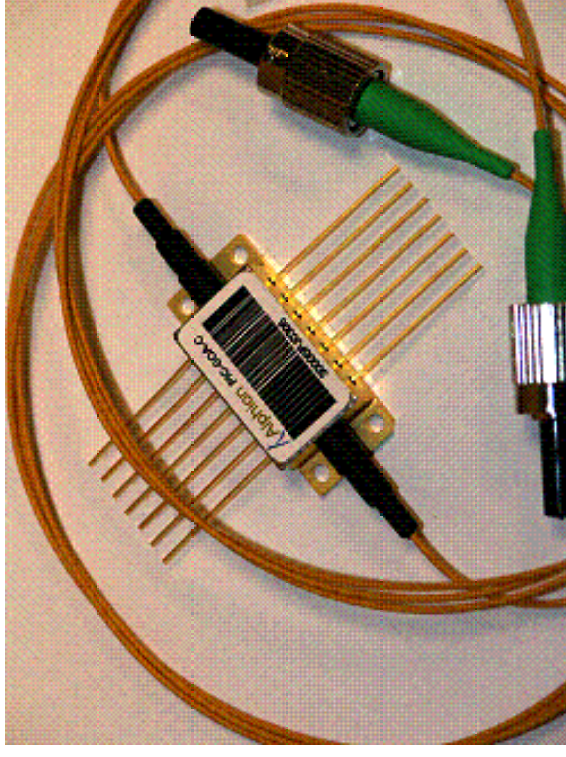

SOAs in PONs

For the purposes of this talk we consider the SOA as an OLT booster or preamp, or as an inline amp.

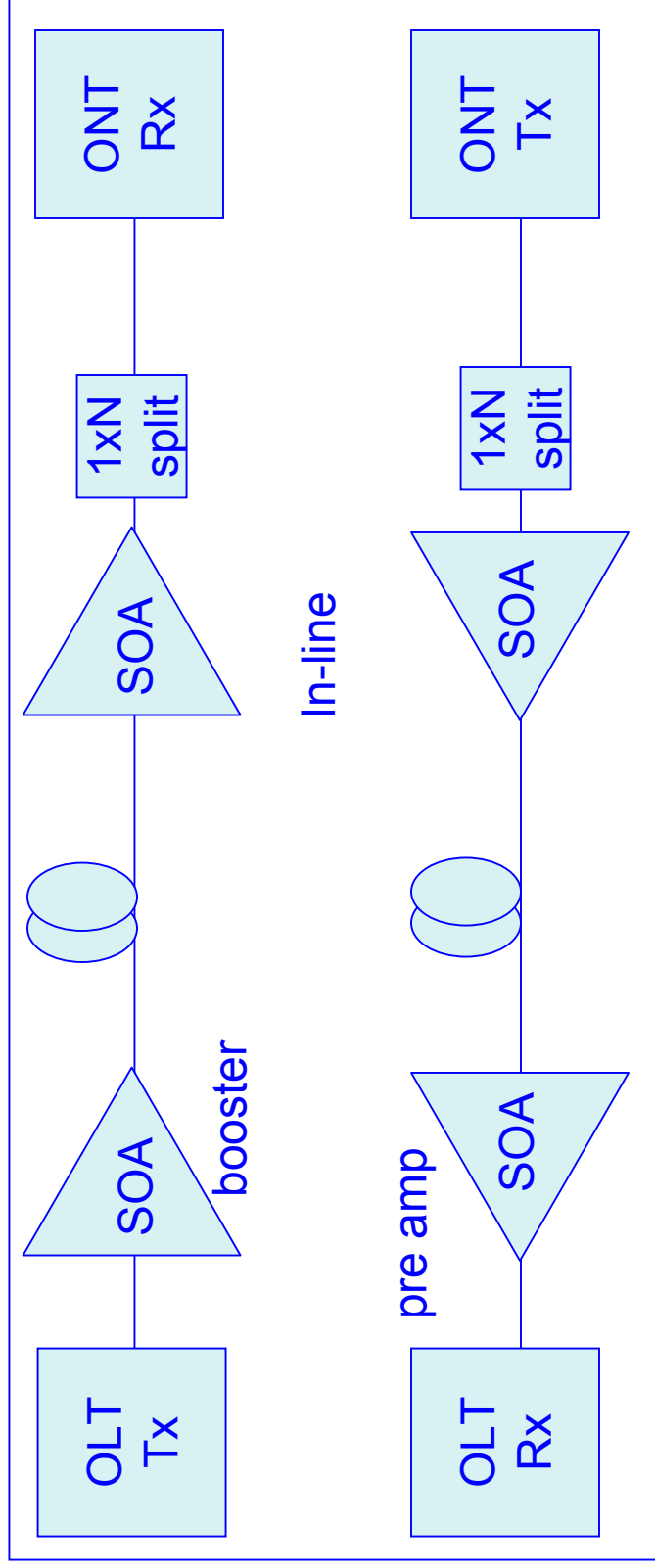

Packaging of SOA chip

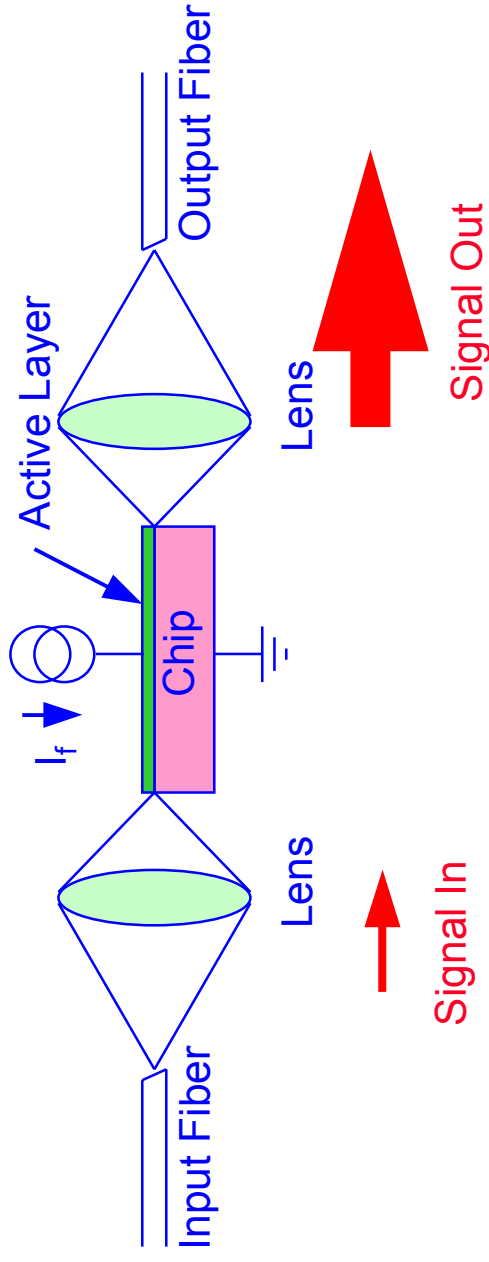

- Buried hetero-structure
- Multi-quantum-well (shown) or bulk active layer
- Extremely low facet reflection: $< 10^{-4}$
 - Angled stripes, Anti-reflection coatings

Operating Principle

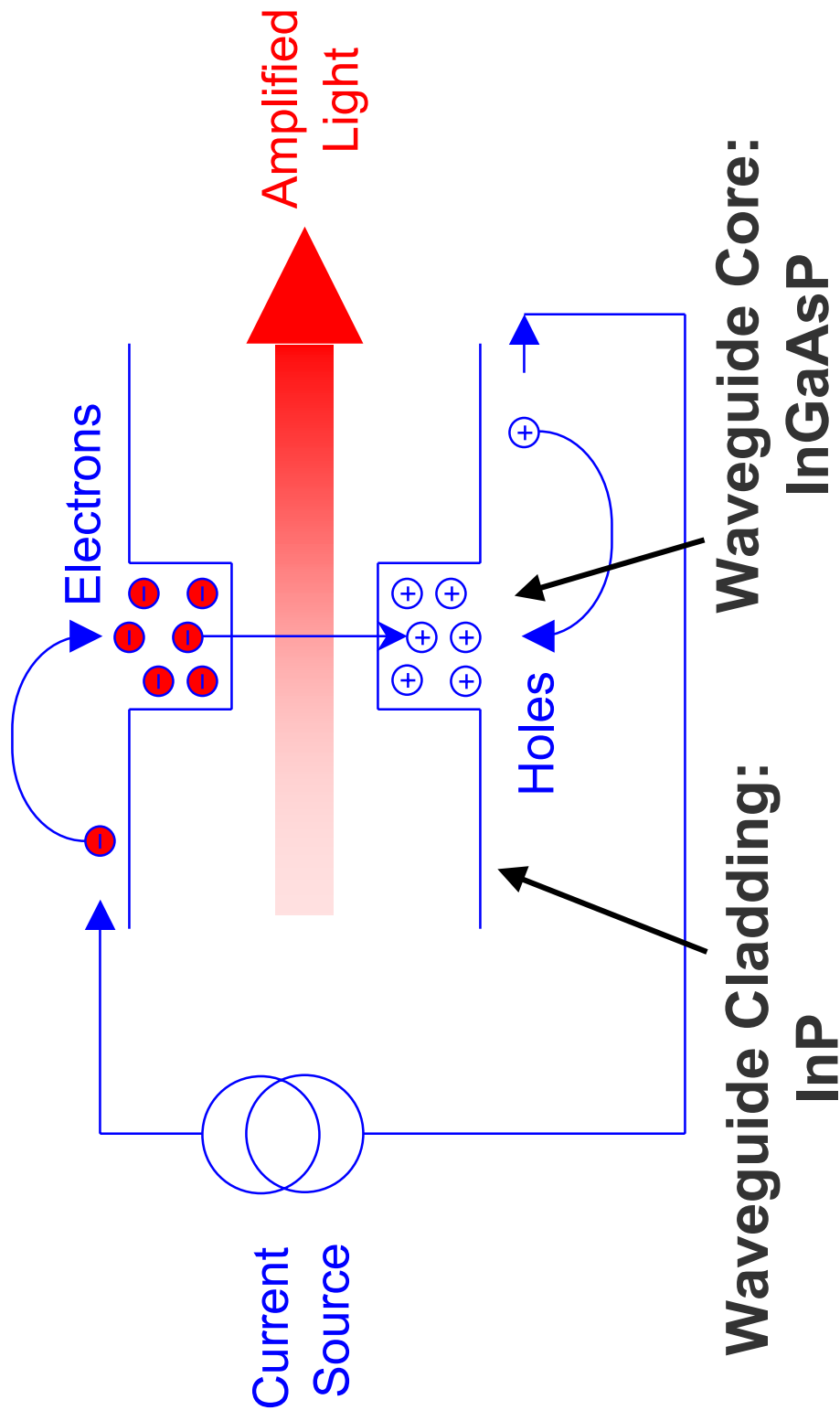

- Stimulated emission around bandgap wavelength of semiconductor
- Bandgap wavelength widely tunable with material composition

SOA Chip

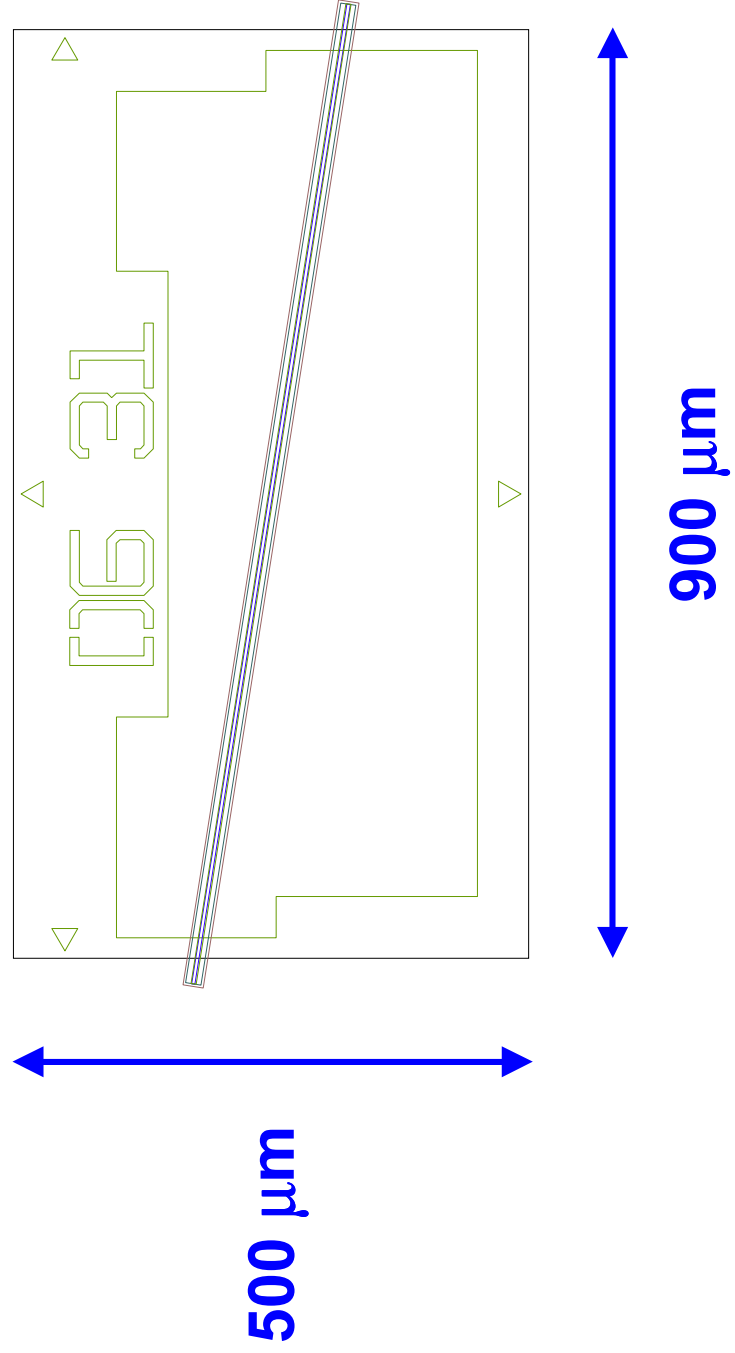

Many SOA chips in a unit cell...

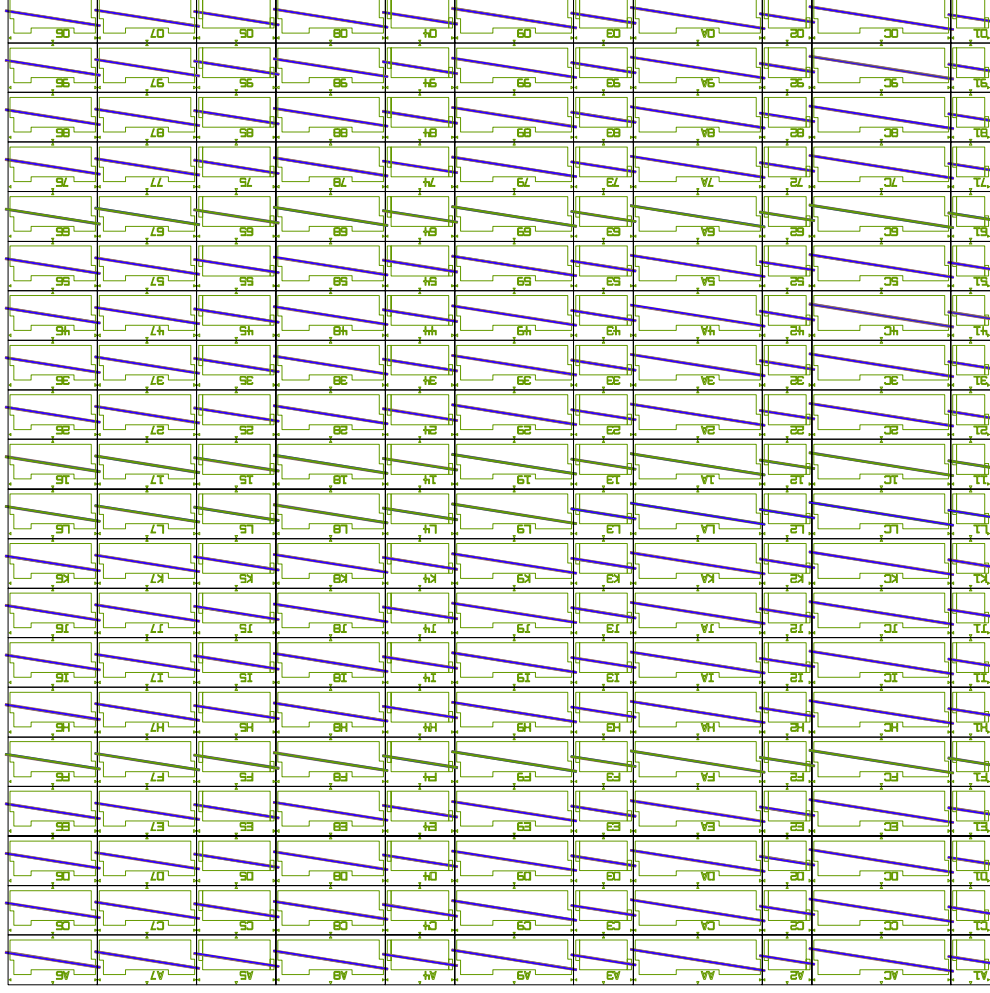

...many unit cells on a wafer

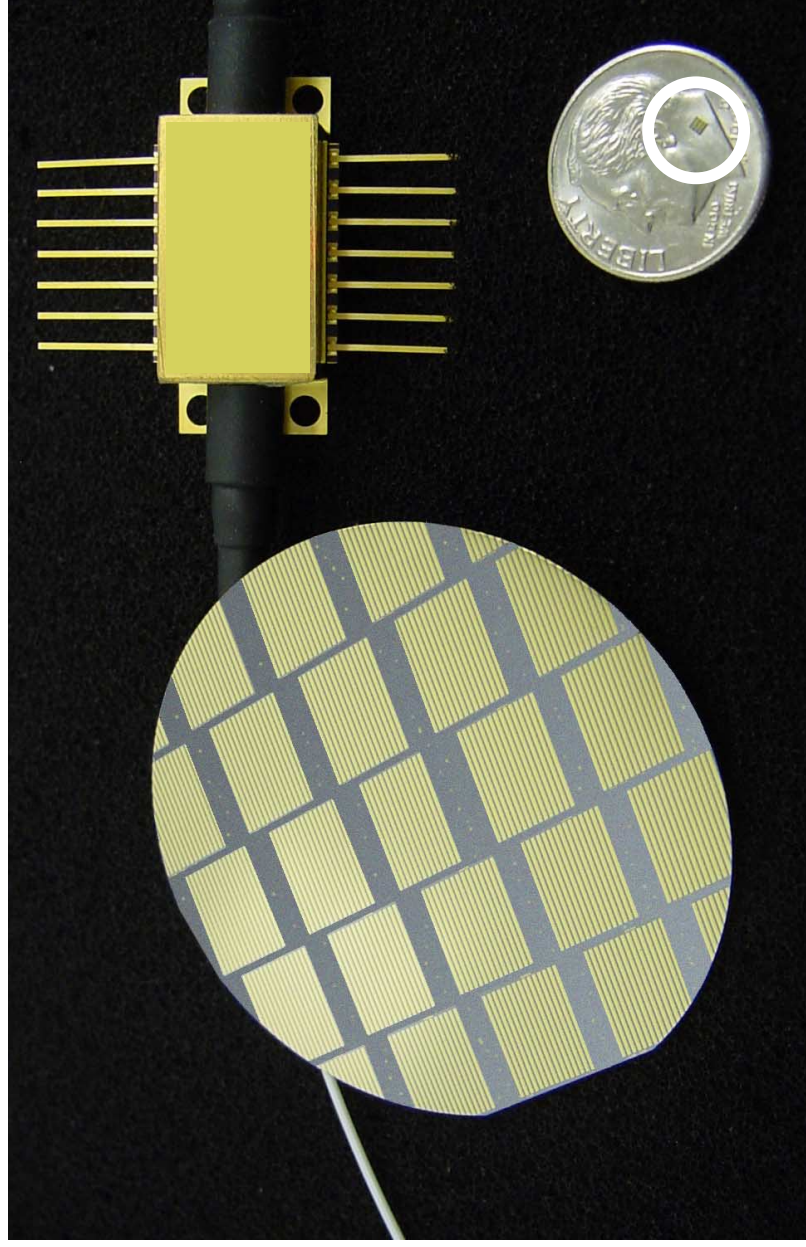

SOA optical properties

Link performance impacted by:

- Gain
- Noise Figure
- Output Power
- ASE Spectrum

Amplified Spontaneous Emission

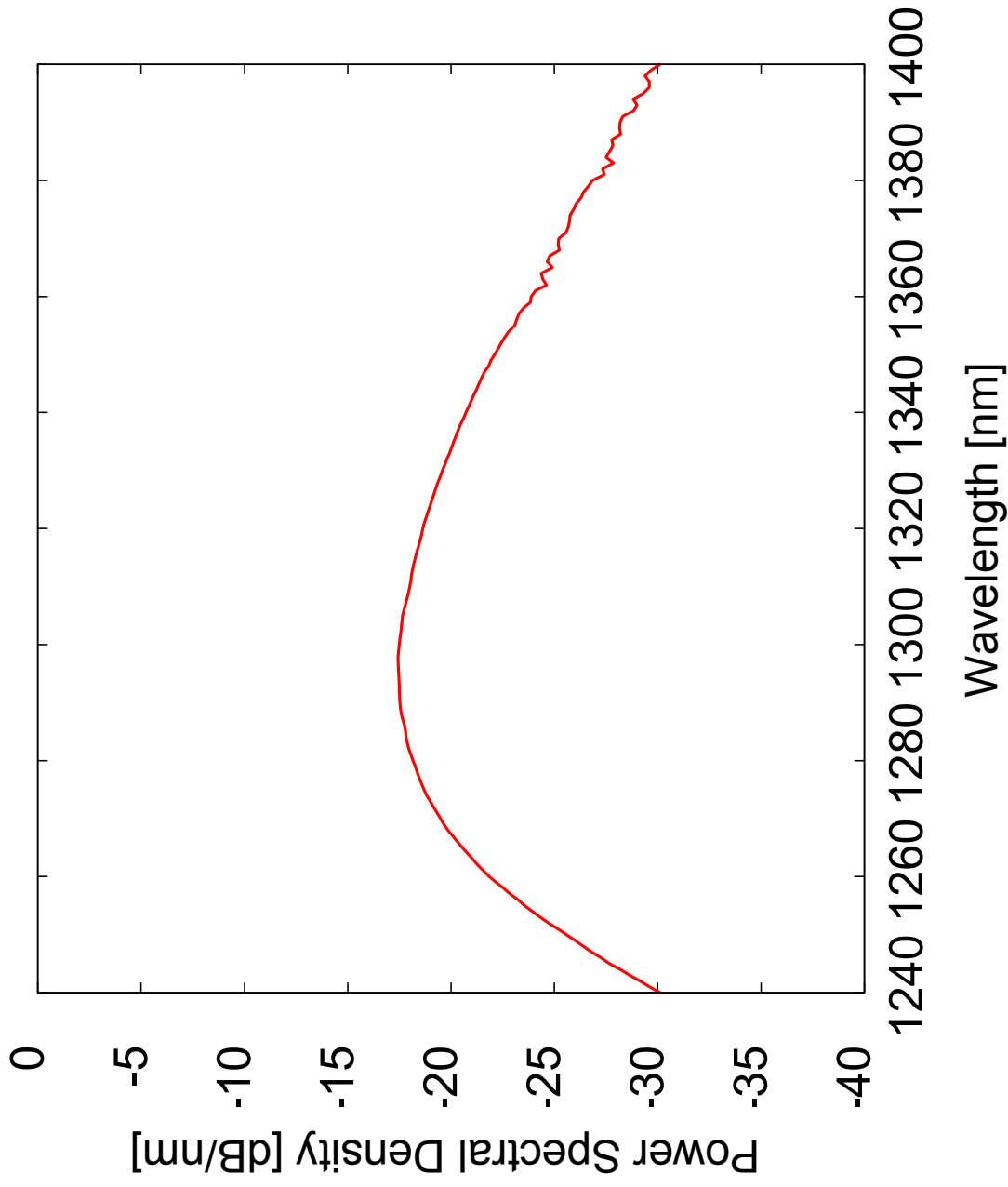

SOA Gain, PDG, NF

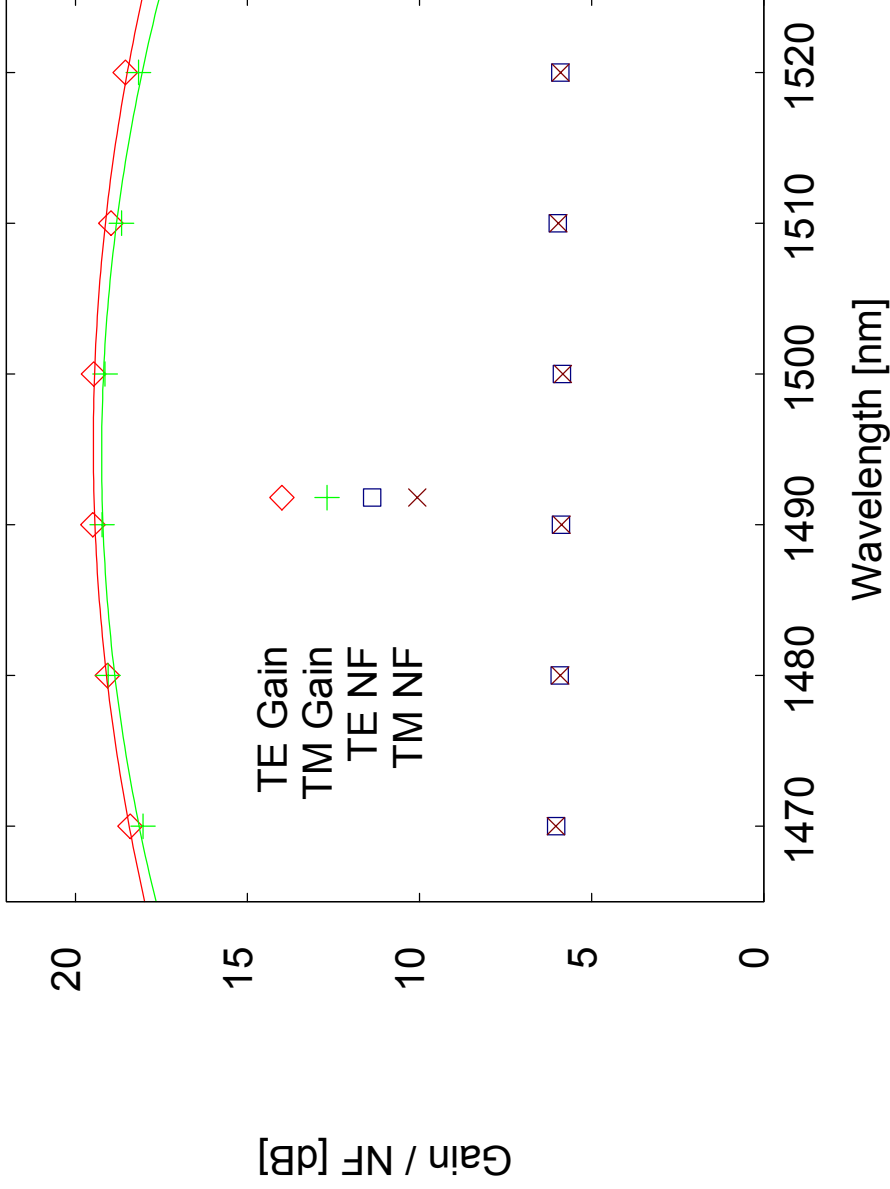

- Smooth parabolic gain shape thanks to semiconductor bands
- 3-dB gain bandwidth approx. 80 nm
- PDG of <0.5 dB can now routinely be achieved
- $NF = 2 n_{sp}/\eta$
 n_{sp} = population inversion factor
 η = fiber-chip coupling efficiency
- Theoretical limit 3 dB

Polarization Dependence

- Polarization independent gain not automatic (unlike EDFA, SOA waveguide not rotationally symmetric)
- Use of strain in crystal to obtain polarization independence

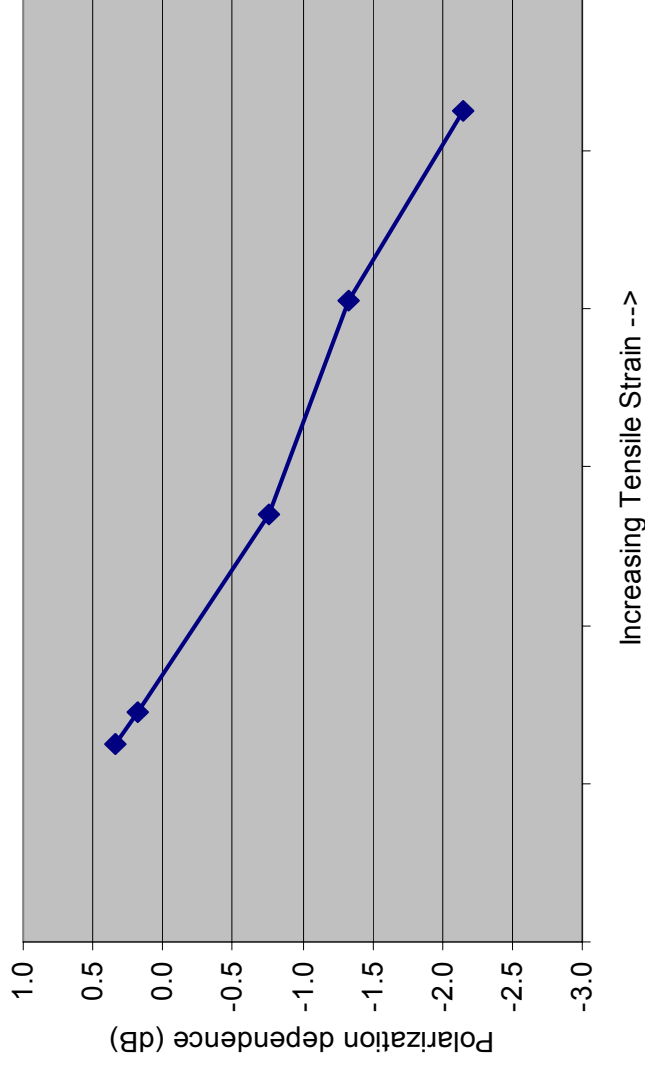

- Tensile strained Quantum Wells
- Alternating Tensile/Compressive Quantum Wells
- Tensile Bulk Layer

SOA Gain Saturation

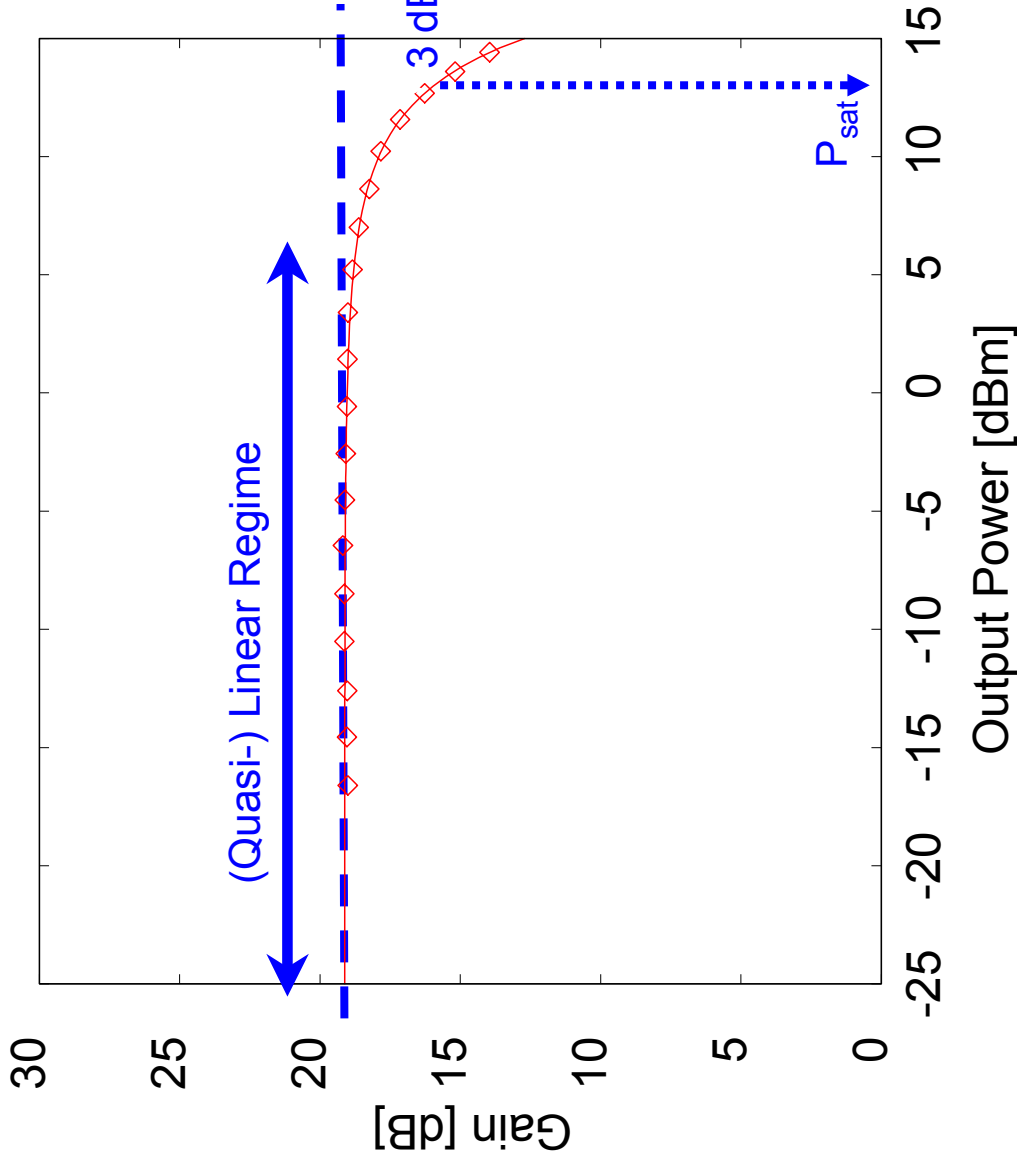

- At large powers, the SOA gain saturates, just like any other amplifier
- But: saturation and gain recovery occur on much faster timescale than in an EDFA, potentially leading to patterning effects

Gain dynamics

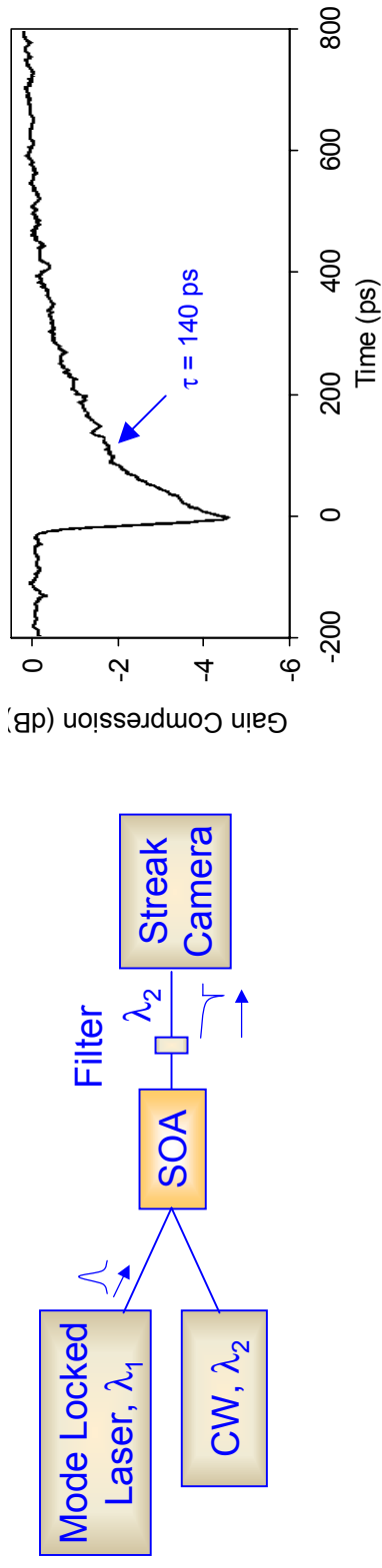

- Gain dynamics measurement using pump-probe technique
- Gain compression almost instantaneous
- Gain recovery of order of bit period for 10 Gb/s data

Use as Booster: Output Power

- Essential difference SOA-EDFA: gain dynamics ultrafast
 - Limits operation to non-saturated regime
 - But beneficial for burst data
- Typical available output power: +10 dBm
- Higher power available for more injection current

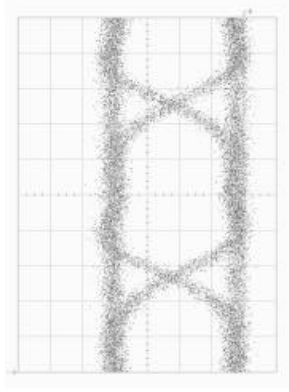

linear

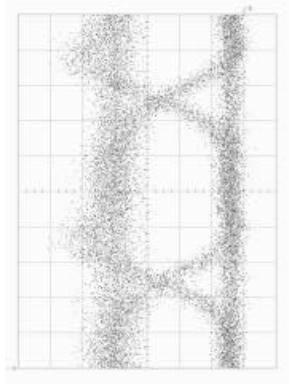

saturated

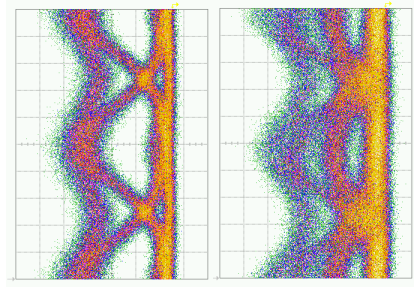

Burst data:

SOA

EDFA

ASE filtering

- Depending on the situation, the ASE emitted by the SOA can impact the sensitivity of the receiver
- Filtering this noise with an optical band pass filter improves performance at the cost of
 - The optical filter
 - The wavelength stability specification of the transmitter

Use as Pre-Amplifier: Noise Figure and ASE filtering

- 10 Gb/s results.
- Sensitivity improvement over pin diode depends on width of BPF.
- Note: result shown with a 8-dB NF SOA.
- Sensitivity of -30 dBm at a BER of 10^{-9} for 10 Gb/s CWDM pre-amplifier.
- No filter at all (for 1260 – 1360 nm case): still 7 dB improvement over bare pin.

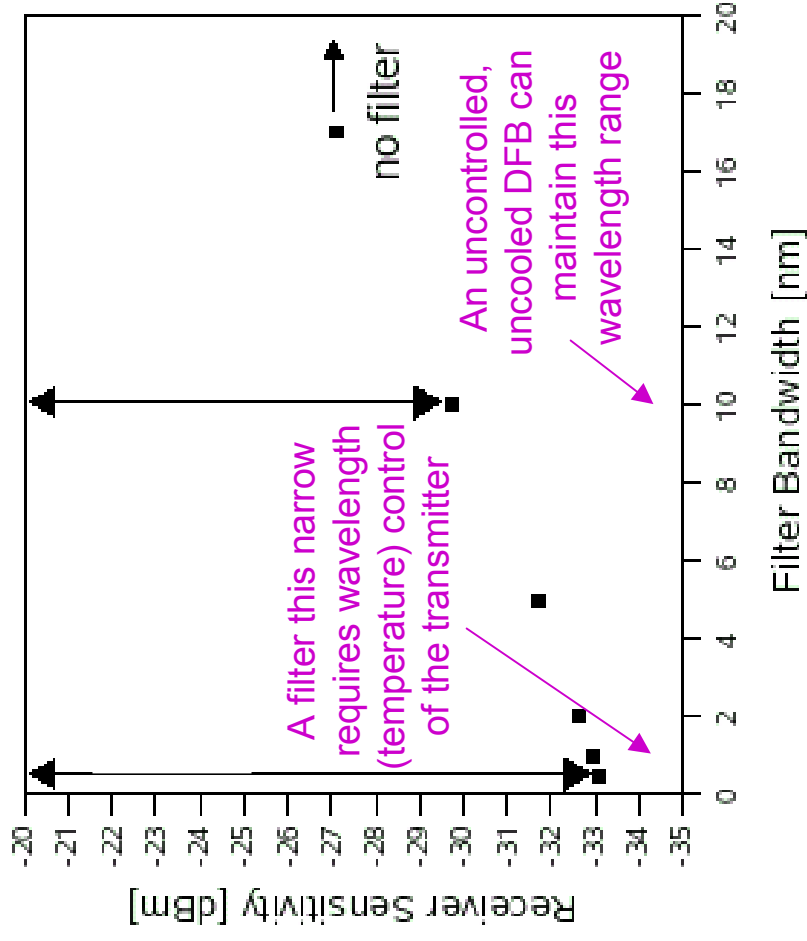

SOA preamplifier

- An SOA pre-amp can improve a 10 Gb/s PIN sensitivity by
 - 7 dB if no optical filter is used
 - 10 dB if a 10 nm optical filter is used
 - 13 dB if a 1 nm optical filter is used
- The optical filter bandwidth will have an impact on the wavelength spec on the transmitter
- This does not account for burst penalty
- SOA+PIN should give equal absolute sensitivity to SOA+APD

SOA as an in-line amplifier

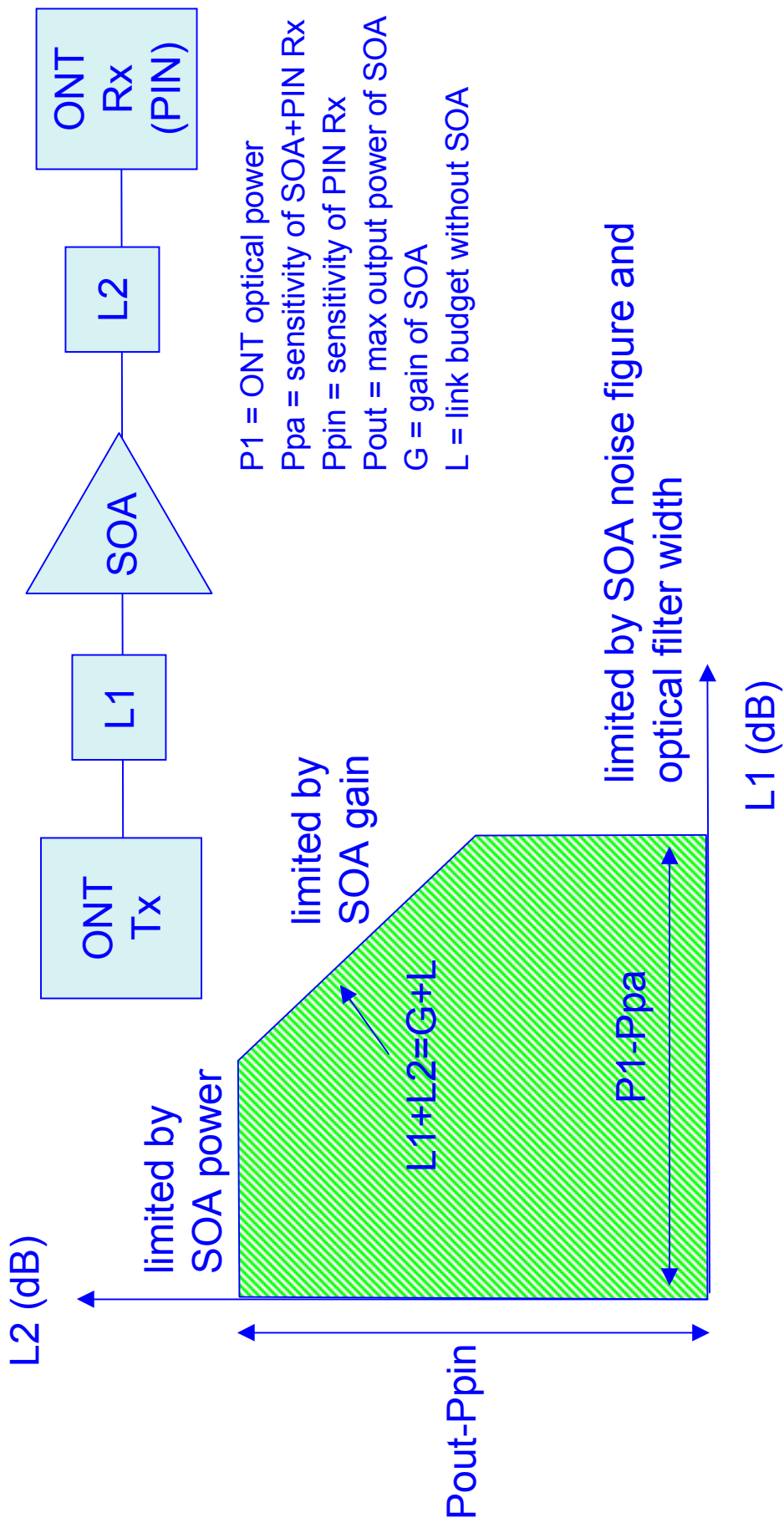

We need to operate inside green area

Example SOA Performance

$P_{\text{ase, fwd}}$	-8.7	±	0.1	dBm
$P_{\text{ase, rev}}$	-8.9	±	0.1	dBm
ASE peak	1494	±	1	nm
Gain ripple	0.17	±	0.02	dB
PDG	0.83	±	0.09	dB
NF	4.9	±	0.1	dB
$P_{\text{sat}} (3\text{-dB})$	14.6	±	0.1	dBm
$P_{\text{sat}} (1\text{-dB})$	11.3	±	0.03	dBm

Use of amplifier in PON

- Optimal location is mid-span
 - ⇒ moderate requirement on both NF, Pout and G
- For amplifier located at OLT:
 - Booster for downstream (req high Pout)
 - Pre-amp for upstream (req low NF)

PON Extension Module

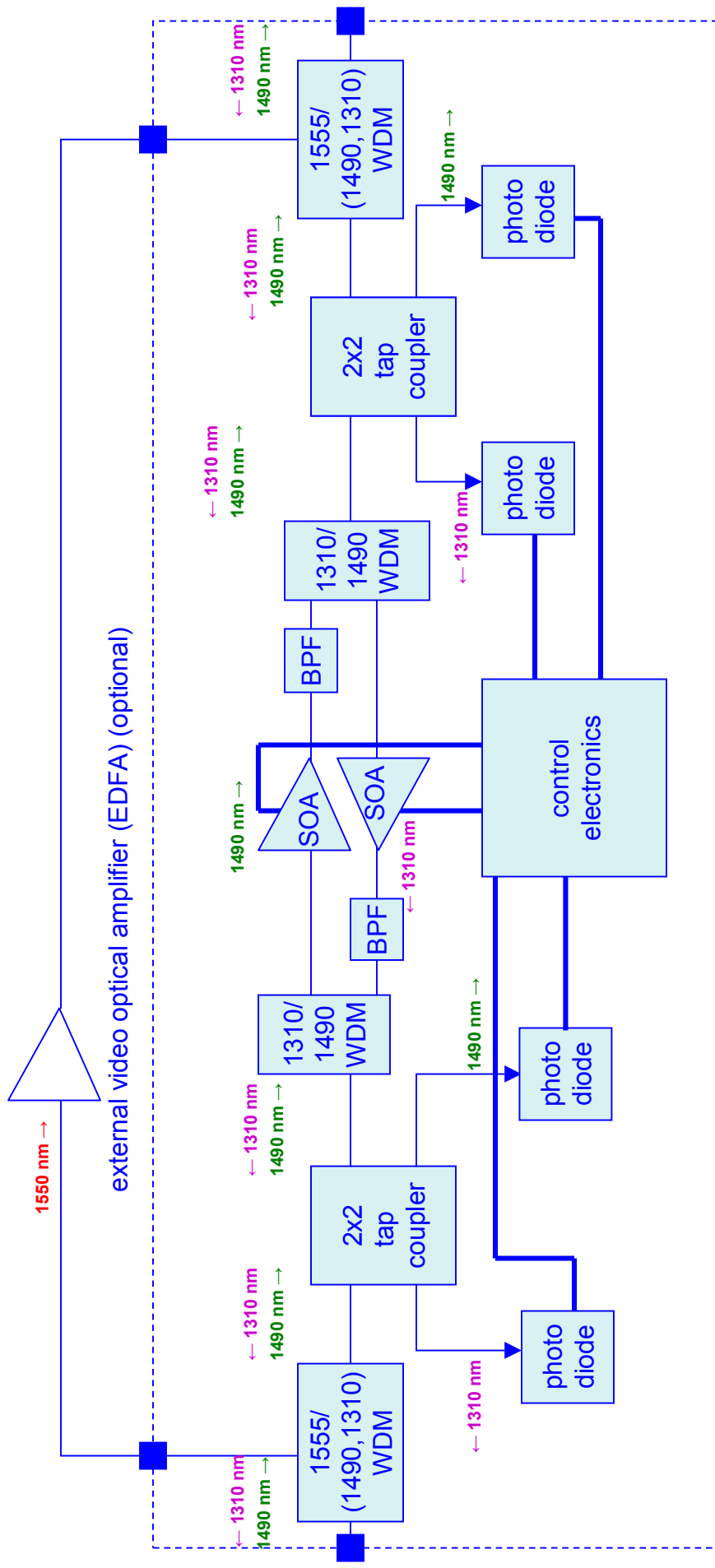

Multi-Channel SOA



2-Channel SOA

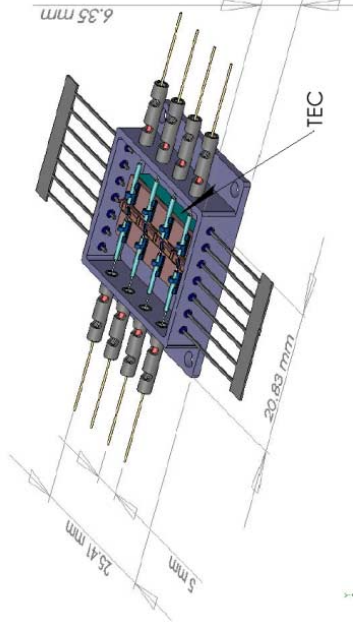

4-Channel SOA

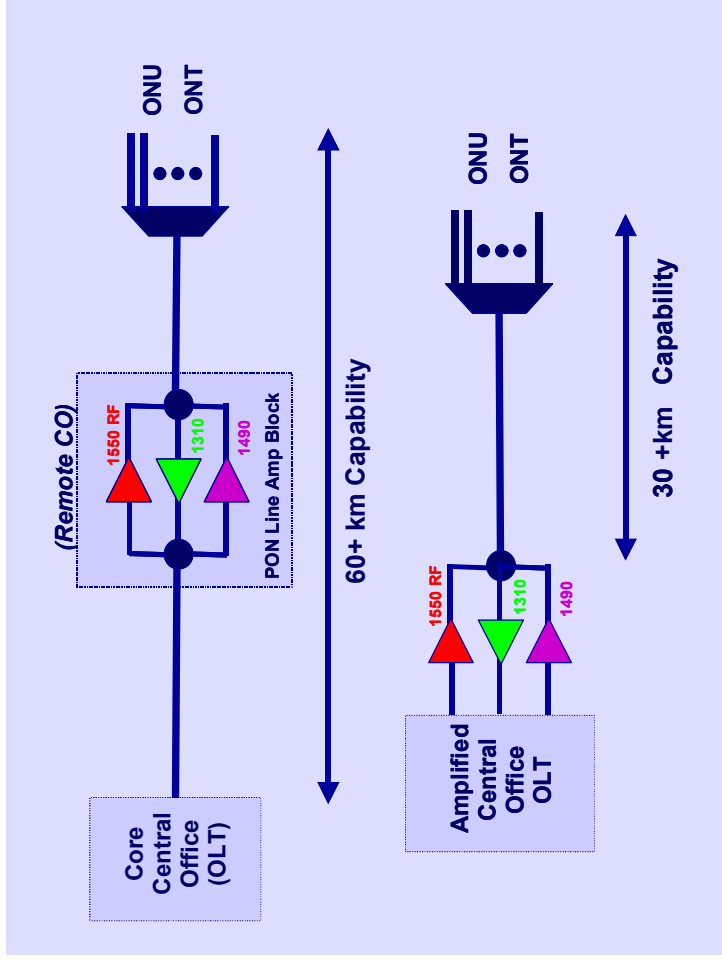

8 x 10 Gb/s WDM over 240 km

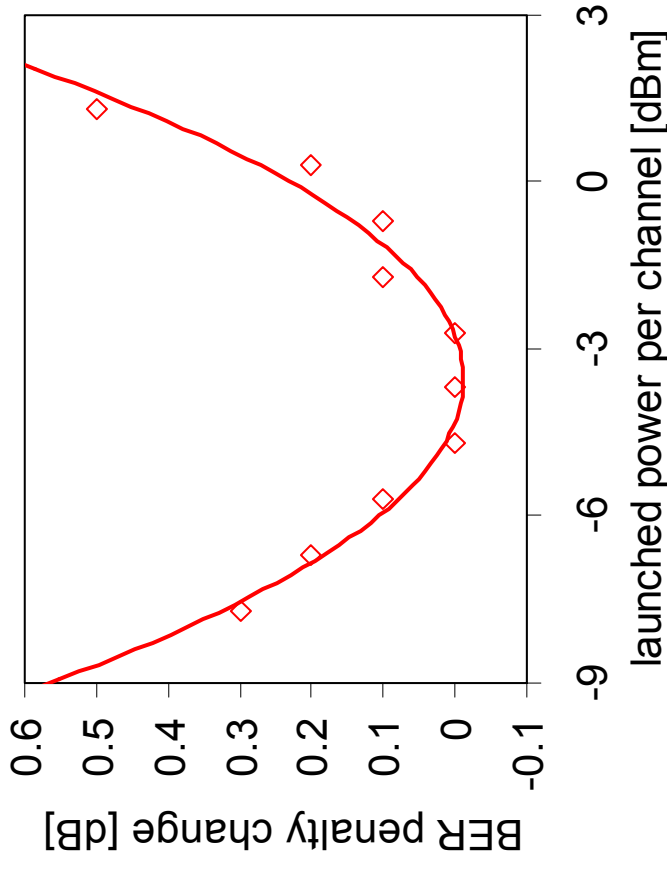
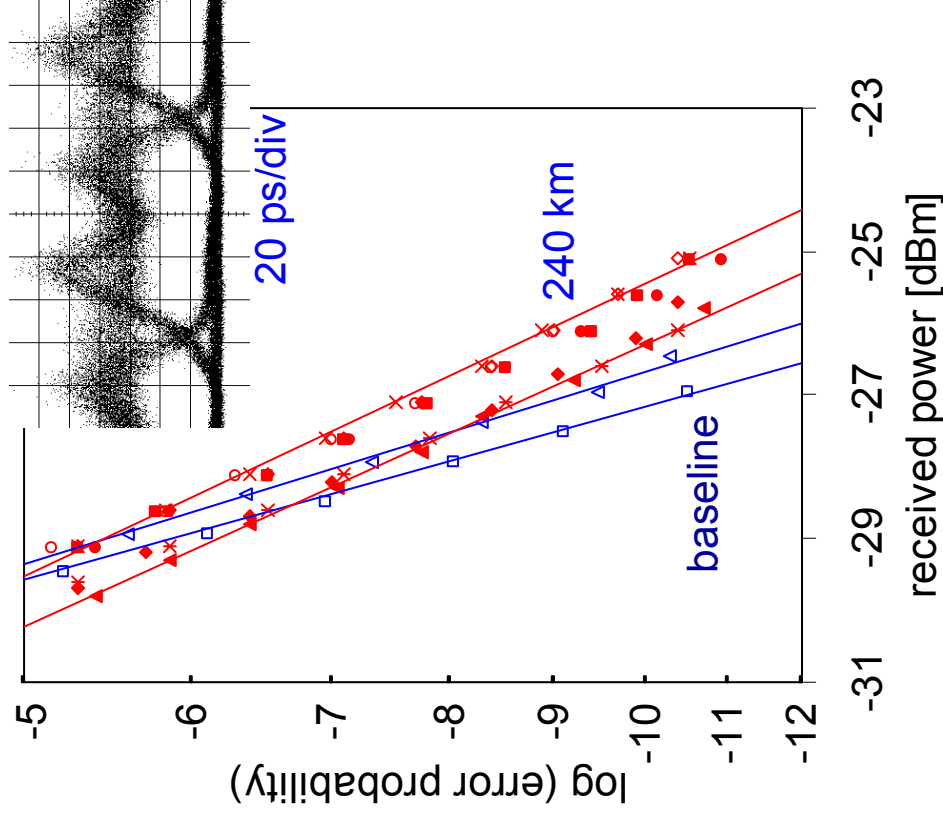

- 0.5 ... 1.5 dB power penalty
- 10 dB launched power tolerance

(L.H. Spiekman *et al.*, *Photon. Technol. Lett.* **12**(8), pp. 1082-4, 2000)

Leo Spiekman, David Piehler, Aliphion Corp. – November 2006

27

Use of SOA in CWDM-PON

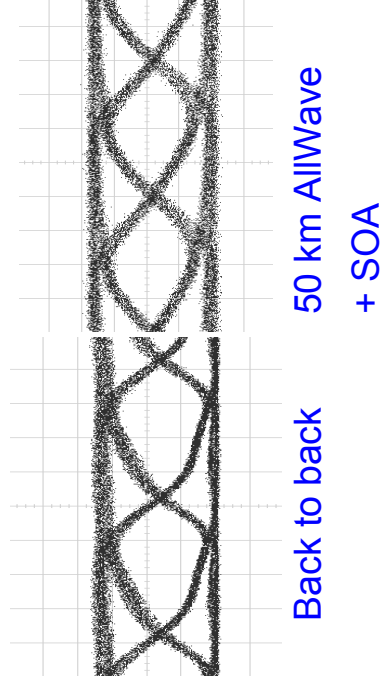
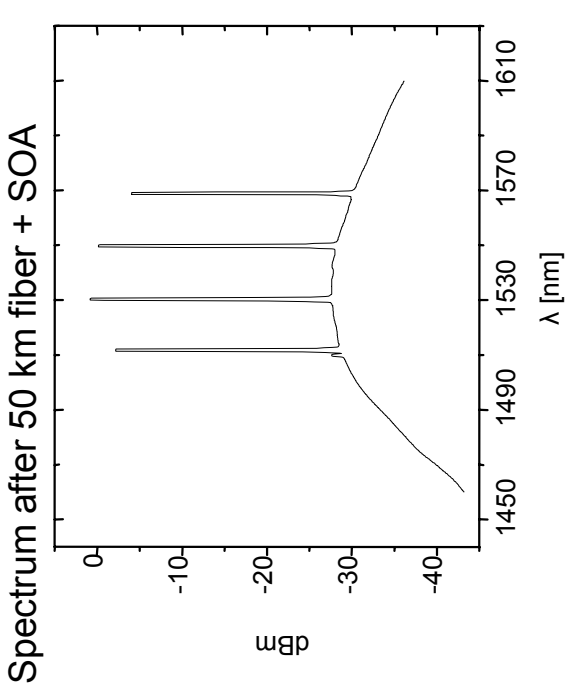

No indication of eye distortion due to cross-gain modulation

H. J. Thiele *et al.*, OFC 2003, paper MF21.

Taking Advantage of Broad SOA Gain Bandwidth

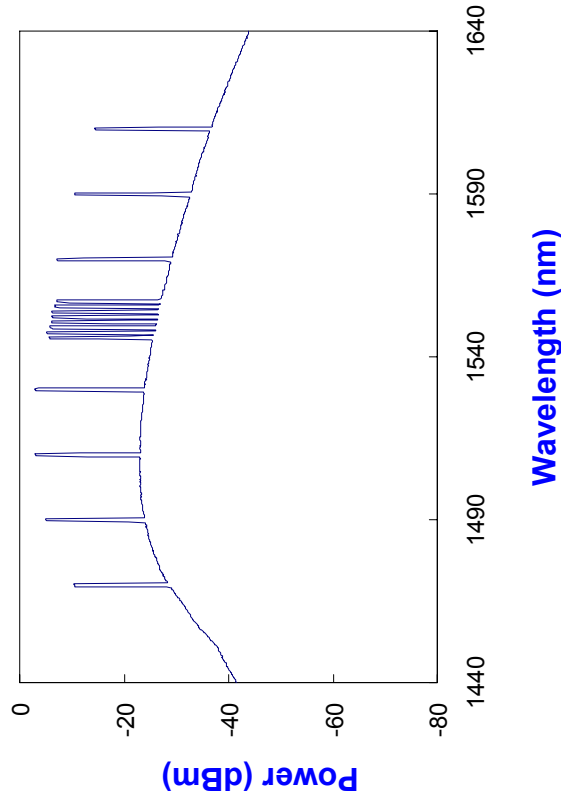
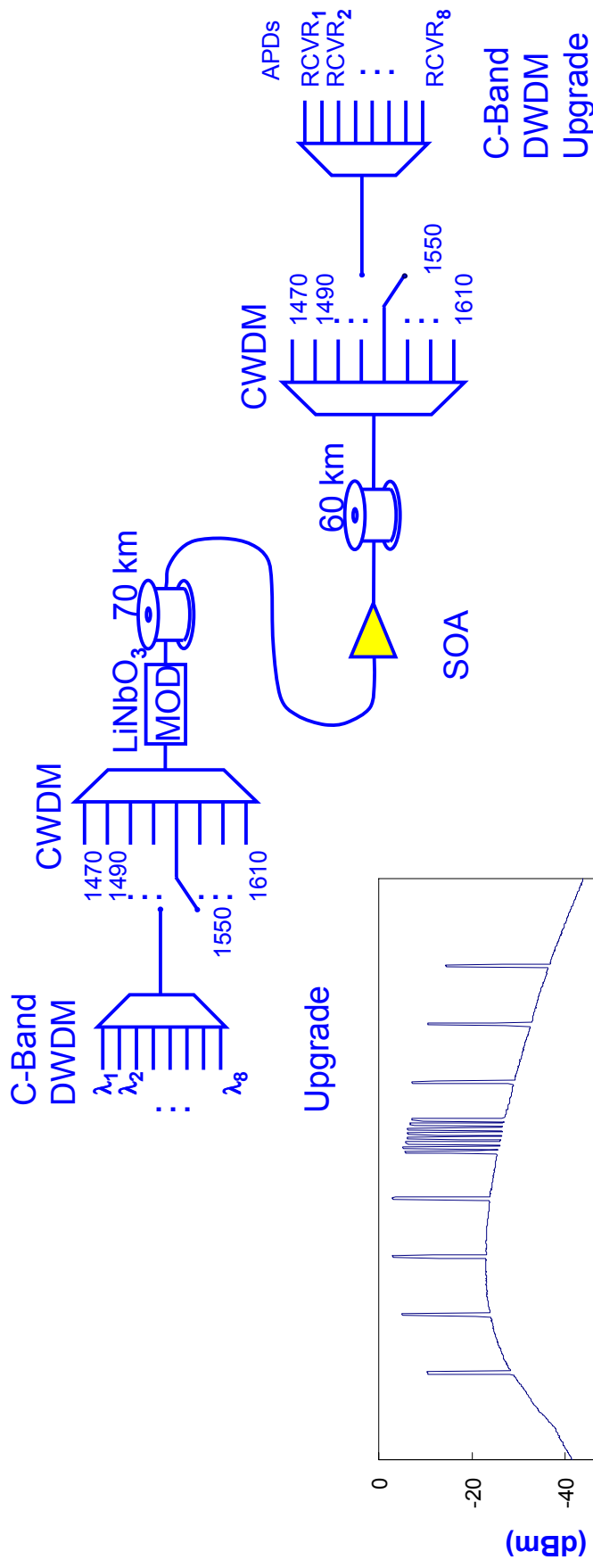

- Eight CWDM channels amplified by a single SOA
- Upgrade by replacing middle CWDM channel with 8 DWDM channels.

(P.P. Iannone et al., OFC 2003, paper ThQ3)

SOA as a data modulator

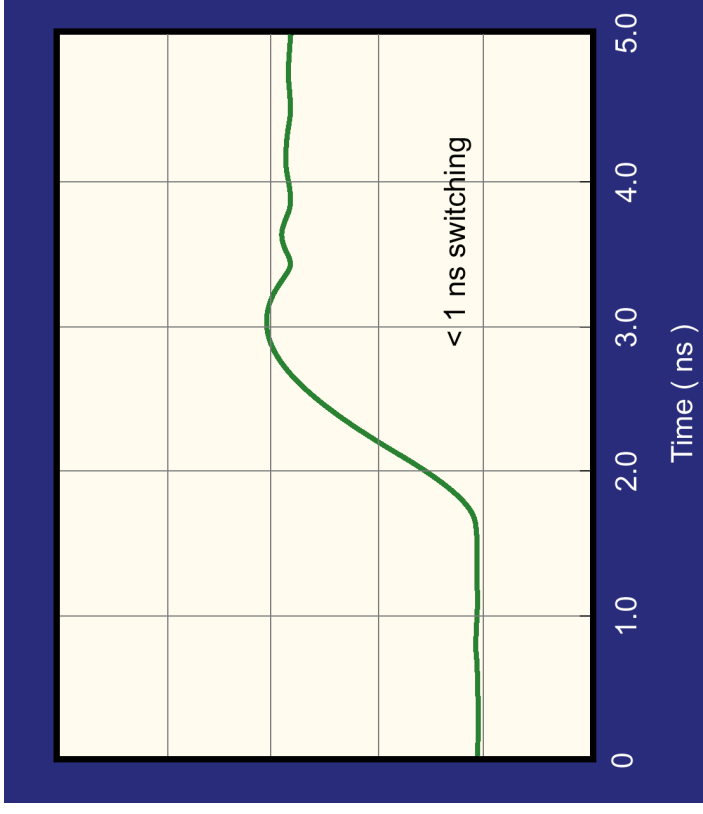
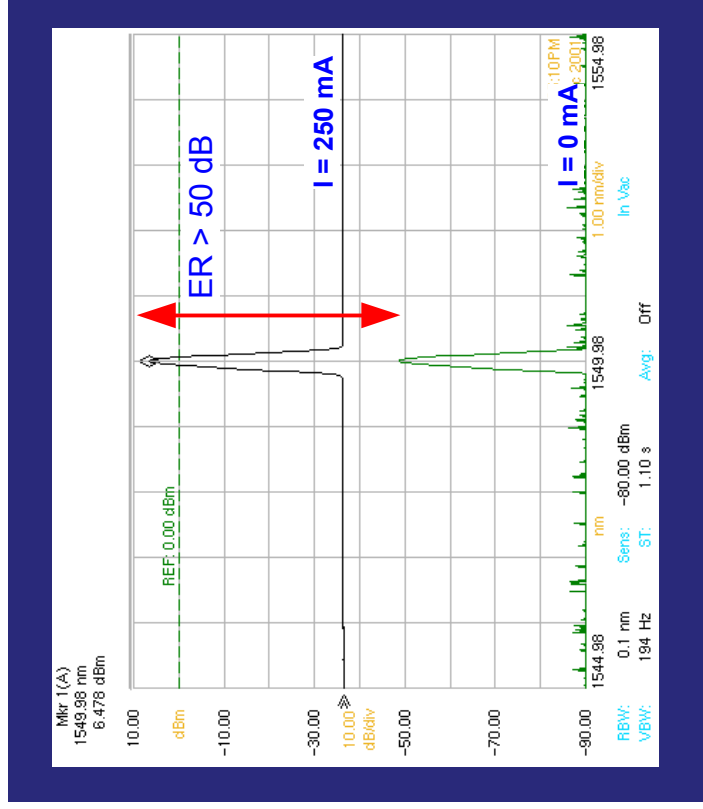

- High contrast ($> 40 \text{ dB}$)
- Fast ($< \text{ns}$)

Wavelength-agnostic example in an access network

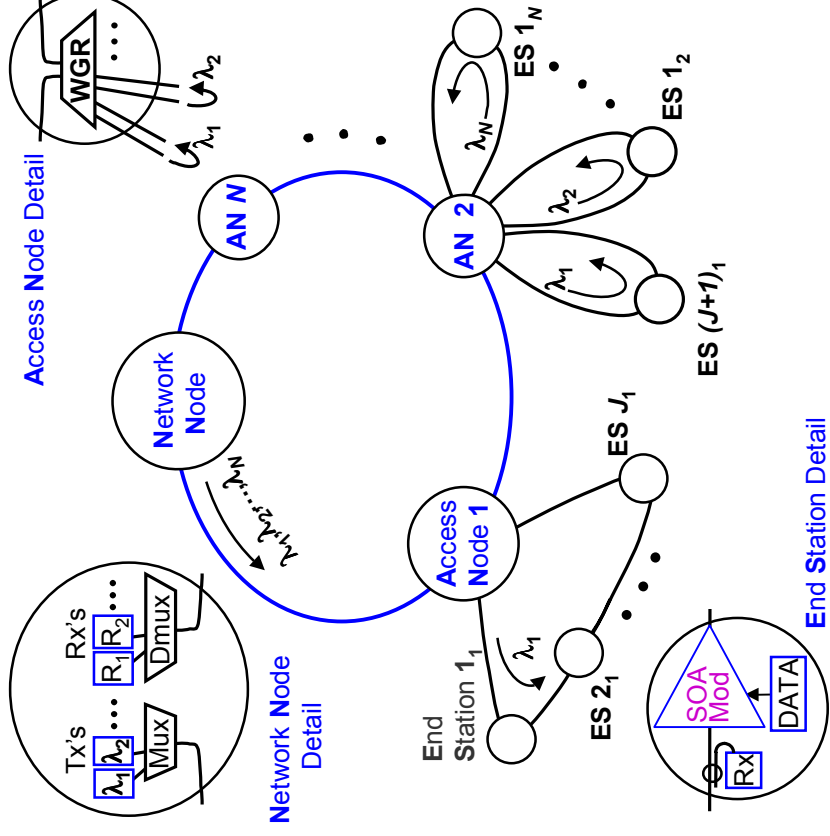

Can also be configured as reflective SOA: single fiber to ONU

P. Iannone, et al., J. Lightwave Tech., 18, 1955 (2000).

Reflective SOA

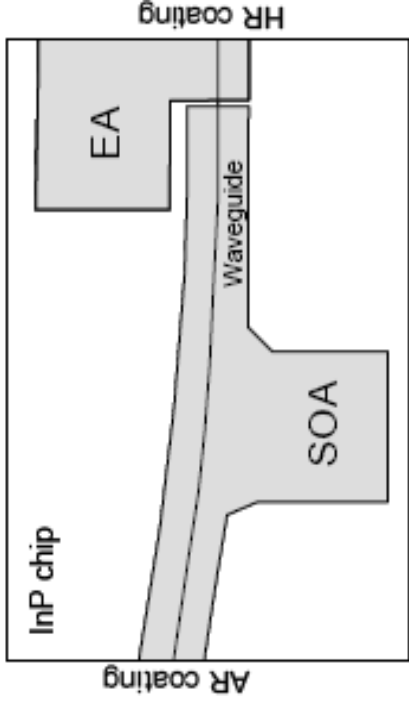

5 Gb/s

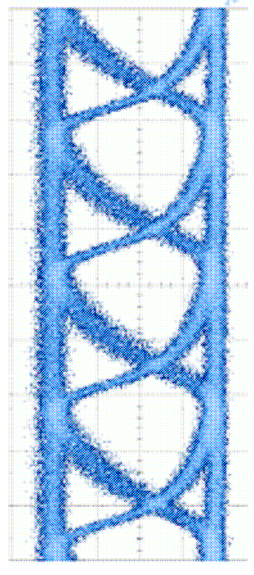

- Single fiber connection
- Cheap packaging (TO-can)
- Currently assumed to be externally cooled

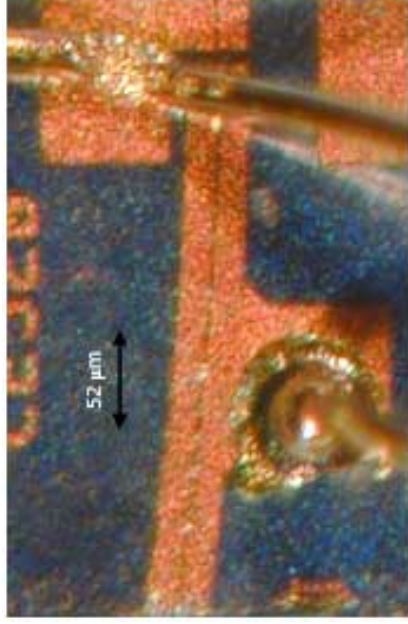

(I. Tafur Monroy *et al.*, *Optics Express* **14**(18), pp. 8060-4, 2006)

Leo Spiekman, David Piehler, Aliphion Corp. – November 2006

32

Summary

- Amplification in access allows system margin enhancement
- SOA is a candidate technology with a high level of maturity
- Booster allows operation up to at least +10 dBm
- Pre-amplifier increases margin wrt. PIN by 7 – 13 dB, depending on whether filter is permitted
- In-line amplifier can extend distance and split ratio.
- Key advantage is that present PON wavelength assignments are supported
- Growth path towards CWDM-PON available



Alphion

Enabling the photonic future