



IKN
Institut für
Kommunikationsnetze

The Darwin MAC Protocol Mystery

Harmen R. van As, Arben Lila, Günter Remsak, Jon Schuringa
Vienna University of Technology, Austria

IEEE 802.17 Interim Meeting, Ottawa, May 6-9, 2002

Content

The Darwin MAC Protocol

- **Central role of MAC fairness**
- **Weakness of the Darwin proposal**
- **Status of its specification**
- **Performance scenarios**

Central Position of MAC Fairness Control

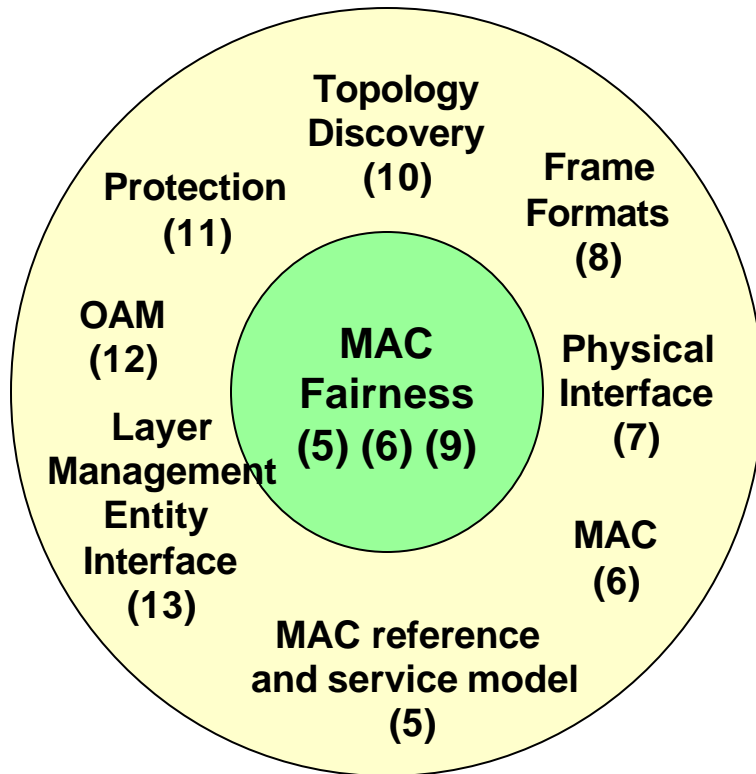

The central position and the complexity of the MAC Fairness Control is still not understood and taken seriously in the IEEE 802.17 community

All other issues are much work but rather straightforward

The IEEE 802.17 community is diligently working and wordsmithing on Clauses 5, 6, and 9 without really knowing how the Darwin MAC protocol behaves and where it stands compared to the other proposals

What we really urgently need first, is sufficient and confident understanding of Darwin's performance behavior !!!!

Rings and MAC Protocols since early 70's

69 70 71 72 73 74 75 76 77 78 79 80 81 82 83 84 85 86 87 88 89 90 91 92 93 94

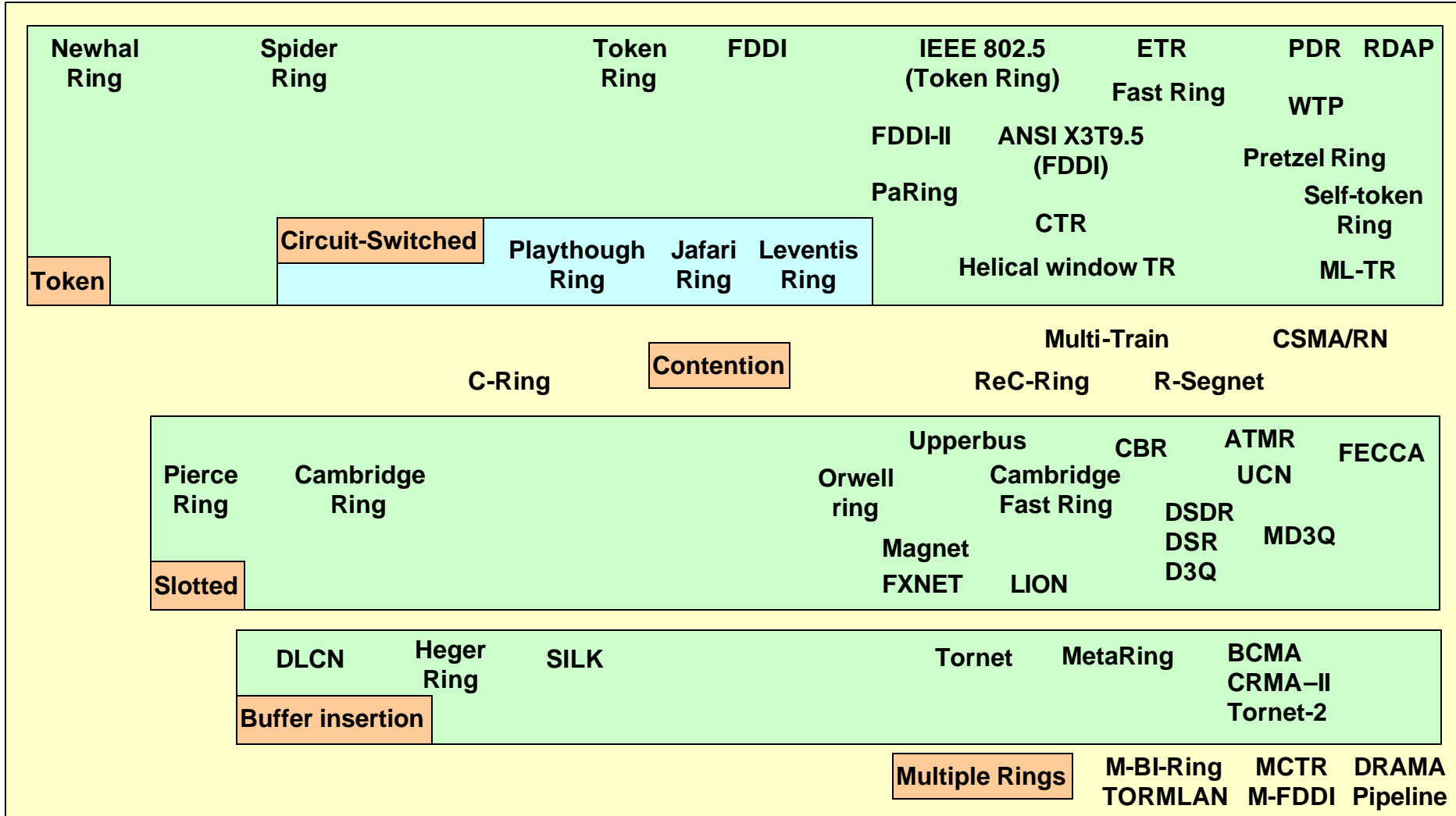

Rings and MAC Protocols since early 70's

ATMR	ATM Ring		
BCMA	Buffer-Insertion Cell-Synchronized Multiple Access		
C-Ring	Contention Ring		
CRMA-II	Cyclic Reservation Multiple Access, version II		
CSMA-RN	CSMA Ring Network		
CTR	Concurrent Token Ring		
RDAP	Restricted-Destination Access Protocol		
DLCN	Distributed Loop Computer Network		
DRAMA	Dynamic Resource Allocation for Metropolitan Areas		
DSDR	Destination-Stripping Dual Ring		
DSR	Double Slotted Ring		
D3Q	Dynamic Distributed Dual Queue		
ETR	Early Token Release		
FDDI	Fiber Distributed Data Interface		
FECOA	Fair and Efficient Cycle Control Algorithm		
FXNET	Ring with fixed-length cycles		
MD3Q	Multirequest M3Q		
ML-TR	Multiple Logical Token Ring	TORNET	Ring Network of University of Toronto
PaRing	Parallel Transmission Ring	TORMLAN	Token-Ring controlled Multichannel Network
PDR	Partial Destination Removal	UCN	Universal Channel Network
ReC-Ring	Resolvable Contention Ring	WTP	Weak Token Protocol

Reference:

H.R. van As, Media Access Techniques: The Evolution towards terabit/s LANs and MANs, Computer and ISDN Systems, Vol.26, No. 6-8, March, 1994, pp.603-656

What is Happening ?

- ① Packet Ring products are on the market since years : Cisco SRP, Nortel, ...
- ② In July 2001 an alliance of companies stood up and announced to standardize a clean-sheet MAC fairness protocol.
- ③ What happened since then?
Press rumors and speculations say:
 - High-Level company agreements forced battles to stop.
 - Economic-politics overruled innovative approaches.
 - Adaptations to existing Cisco's MAC-Chips are ready or finished soon.
 - Cisco and Nortel will earn on every RPR sold in the future due to patents.
- ④ Alliance became quiet and the IEEE 802.17 community chose to take the Darwin proposal → Cisco's MAC was inherently included.
- ⑤ So far that is part of the game. But now there is no incentives anymore from side of the originators to quickly specify the mechanisms clearly or to convince the audience that the Darwin MAC protocol behaves properly.

Basic Structure of Stations

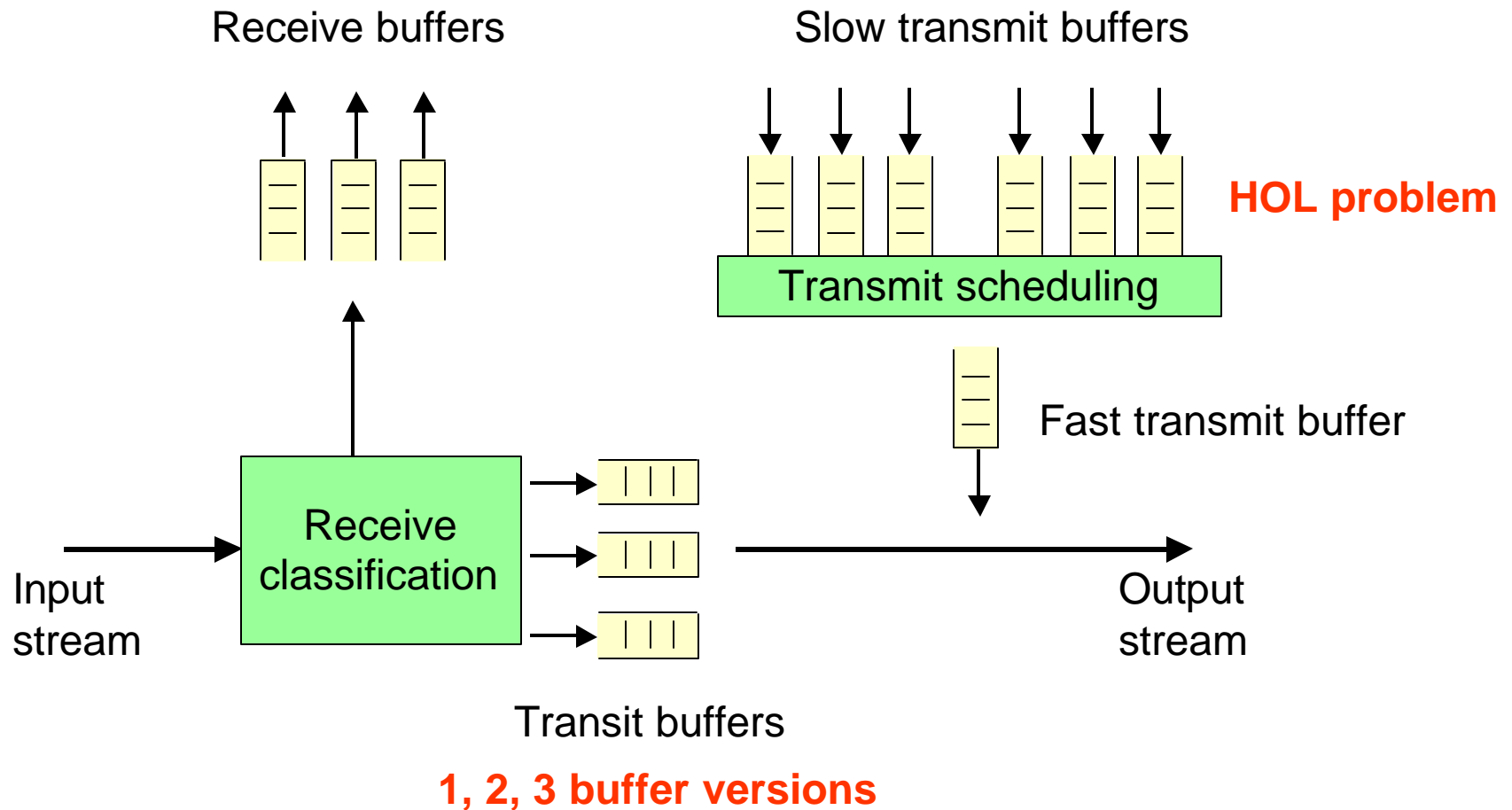

Support of Three Priorities

▪ High Priority

- Guaranteed bandwidth (provisioned)
- Bounded delay and bounded jitter

▪ Medium Priority

- Committed Access Rate (CAR) for MP (cMP)
- MP Traffic exceeding CAR (eMP) is subject to fairness algorithm control
- Committed bandwidth (provisioned), best effort for excess traffic
- Bounded delay and (loosely) bounded jitter

▪ Low Priority

- No guarantees but is subject to fairness algorithm
- Best effort for bandwidth, delay and jitter

Darwin MAC Protocol

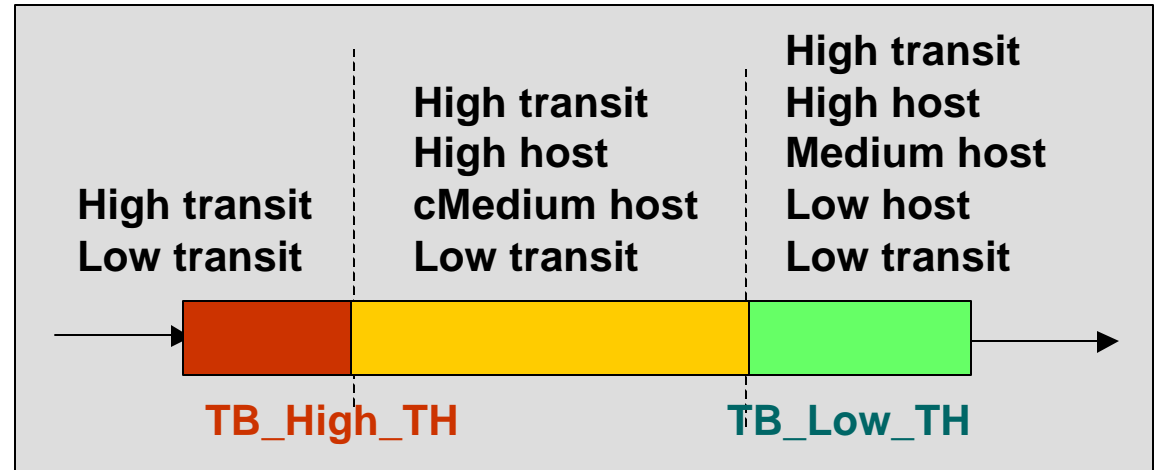
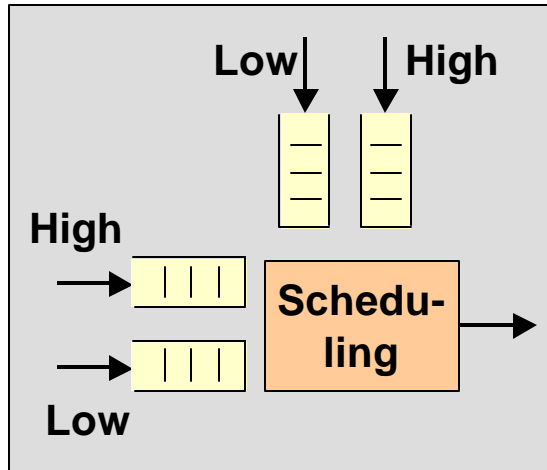

Transit buffer (low priority)

Operation principles :

- Local scheduling between transmit and transit buffers (high, medium, low)
- Backpressure control on threshold passing in transit buffer
- Advertisement to upstream sources to correct their rates accordingly

Weaknesses of the Darwin MAC Protocol

- ① **Transmission path used for scheduling**
 - This is a packet switching technique and does not belong to LANs
 - Frequently transit buffer occupancies are high → large end-to-end delays
 - Best-effort priority always impacts medium-priority (same transit buffer)
 - Best-effort priority impacts high-priority when single transit buffer available
- ② **Too many heuristic parameters to be set**
 - Transit buffer thresholds
 - Ramp up/down thresholds
 - Low-pass filter parameters
 - Many other
- ③ **One fairness mechanism for medium priority and best effort traffic**
- ④ **Fairness mechanism pre-dominantly reactive**
- ⑤ **Link bottleneck fairness based on source flows**
- ⑥ **Protocol not always behaves fair and it does not scale well**
- ⑦ **Protocol behaves strange in some case**

The Fairness Definition Problem

Number of flows on link:

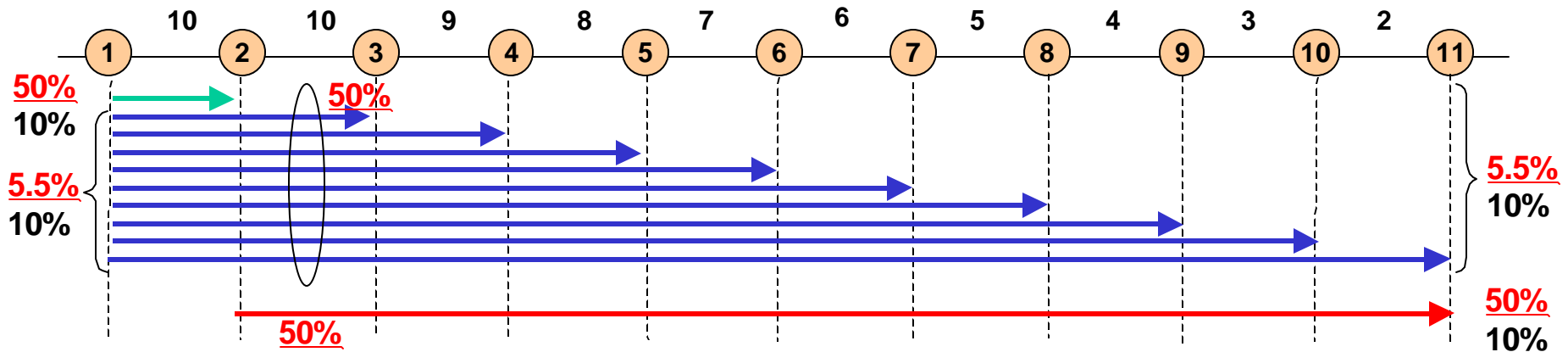

Source fairness: (red underscored values)

- Flows from neighboring stations 1 and 2 to station 11 are very different: 5.5 and 50
 - When a station transmits to many stations, flows may become very small causing problems to TCP-flows
- Giving weights to stations does not work due to traffic matrix dynamics

Source-destination fairness: (black values)

- corresponding flow rate is 10 : 10
- Any weighted combination of source and source-destination fairness can easily be operated dynamically

The Committed Medium-Priority Problem

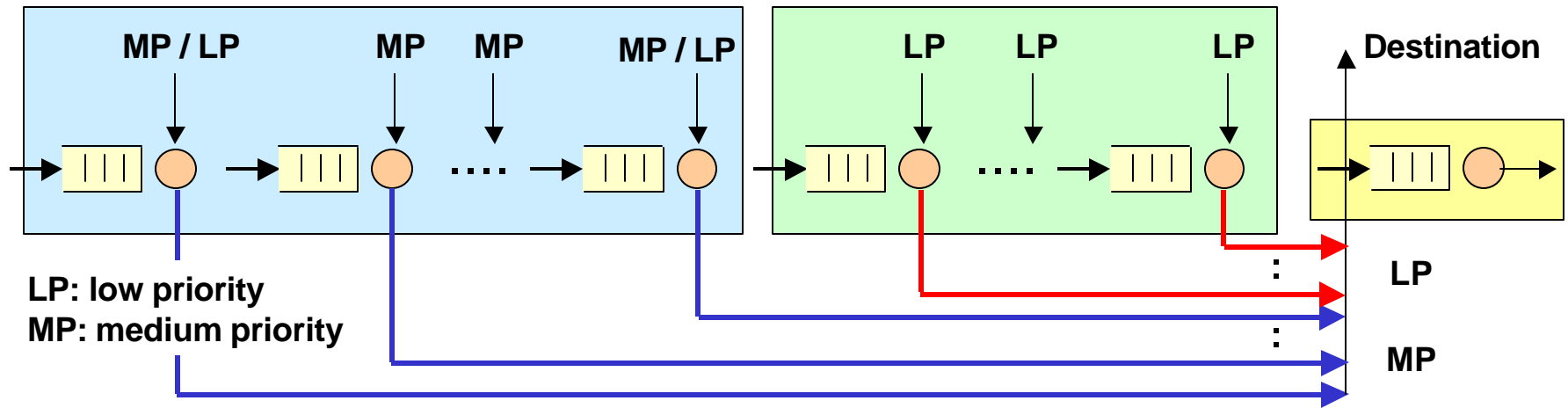

Traffic scenario: All MP (blue) and LP (red) traffic flows go to same destination

Source fairness: (all sources over bottleneck-link obtain same throughput)
Depending on the number of intermediate transit stations with only LP-Traffic,
the committed MP-traffic flows may become too small causing a potential TCP-problem
→ Giving weights to stations does not work due to traffic matrix dynamics

Source-destination fairness: (all flows over bottleneck-link obtain same throughput)
Guaranteed committed MP-flows

Open Points in the Specification

- ① **Pseudo Code is not properly given**
 - Missing parts
 - Ambiguous parts

- ② **The numerous parameters are not properly given**
 - Transit buffer thresholds
 - Ramp up/down thresholds
 - Low pass filter parameters
 - Other

- ③ **Ramp Down / Up mechanism unclear**

What past Simulations did not show

Due to destination release the behavior of MAC protocols of packet rings are principally difficult to predict.

Simulation scenarios shown by various companies never used a ring topology.

- Therefore, fair throughput sharing $1/N$ based on source flows always works.
- In interleaved ring scenarios, this is not necessarily the case.

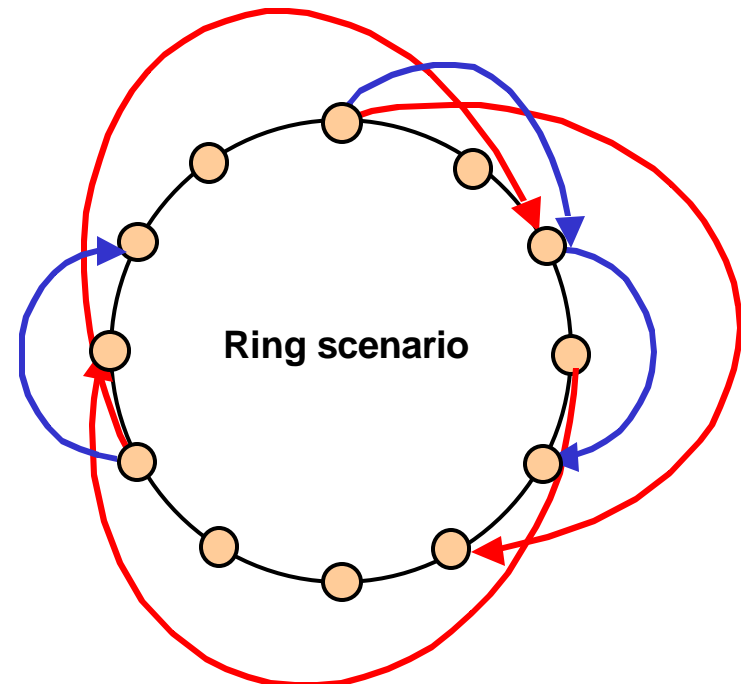
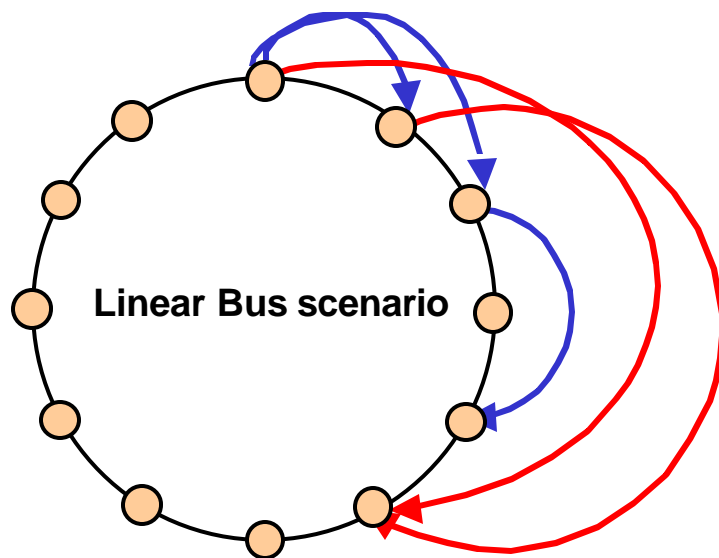

OPNET Models

- ① **Web posting of OPNET models was a nice idea, but does not work**
 - Models are black boxes, no source code is given
 - Output results are essentially fixed
 - Parameter changes are limited
 - Models are not properly described
 - Darwin is not available

- ② **Motion:**

Source code of posted models shall be made accessible

- ③ **Question:**
 - What have companies to hide ???
 - If we want to make progress to understand the MAC, we jointly should work on it.

- ④ **IKN modeled all models in C++**

Traffic Scenario 1

OC-12

Ring length: 100 km

Number of stations: 16

Saturated low-priority traffic

500 Byte packet size - exponential

- Station 2 sends only to 13
- Station 3 sends only to 9
- All other stations send uniformly to all other stations

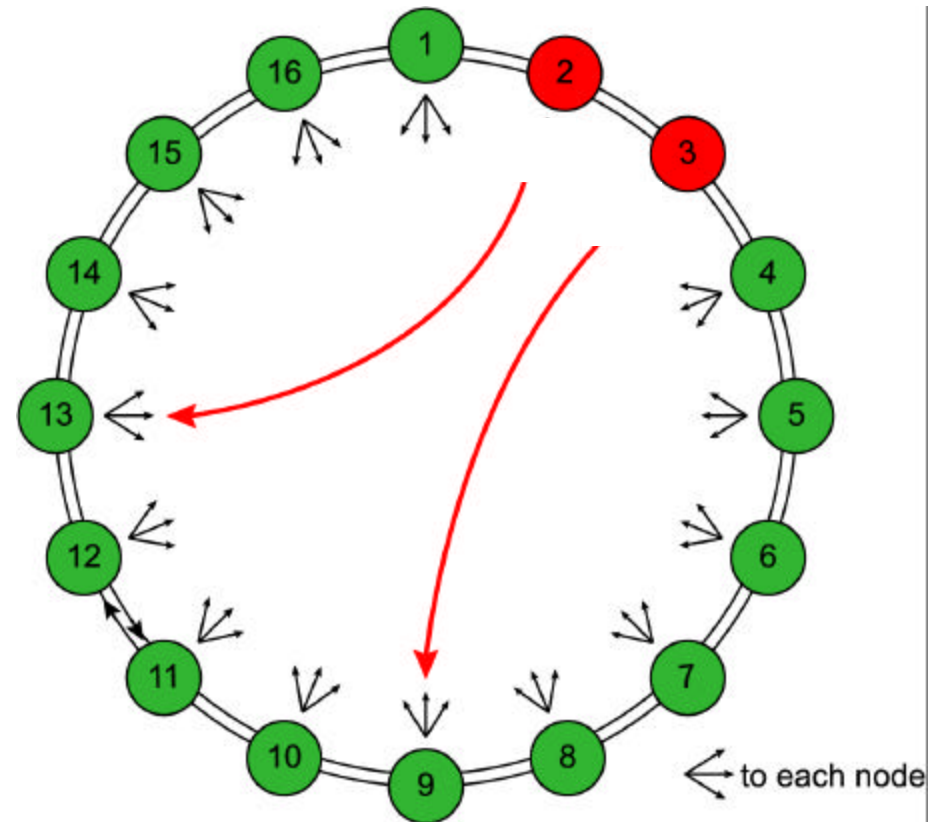

Throughput

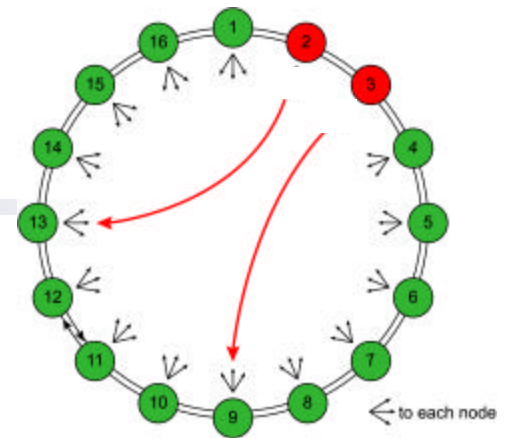

Mbit/s

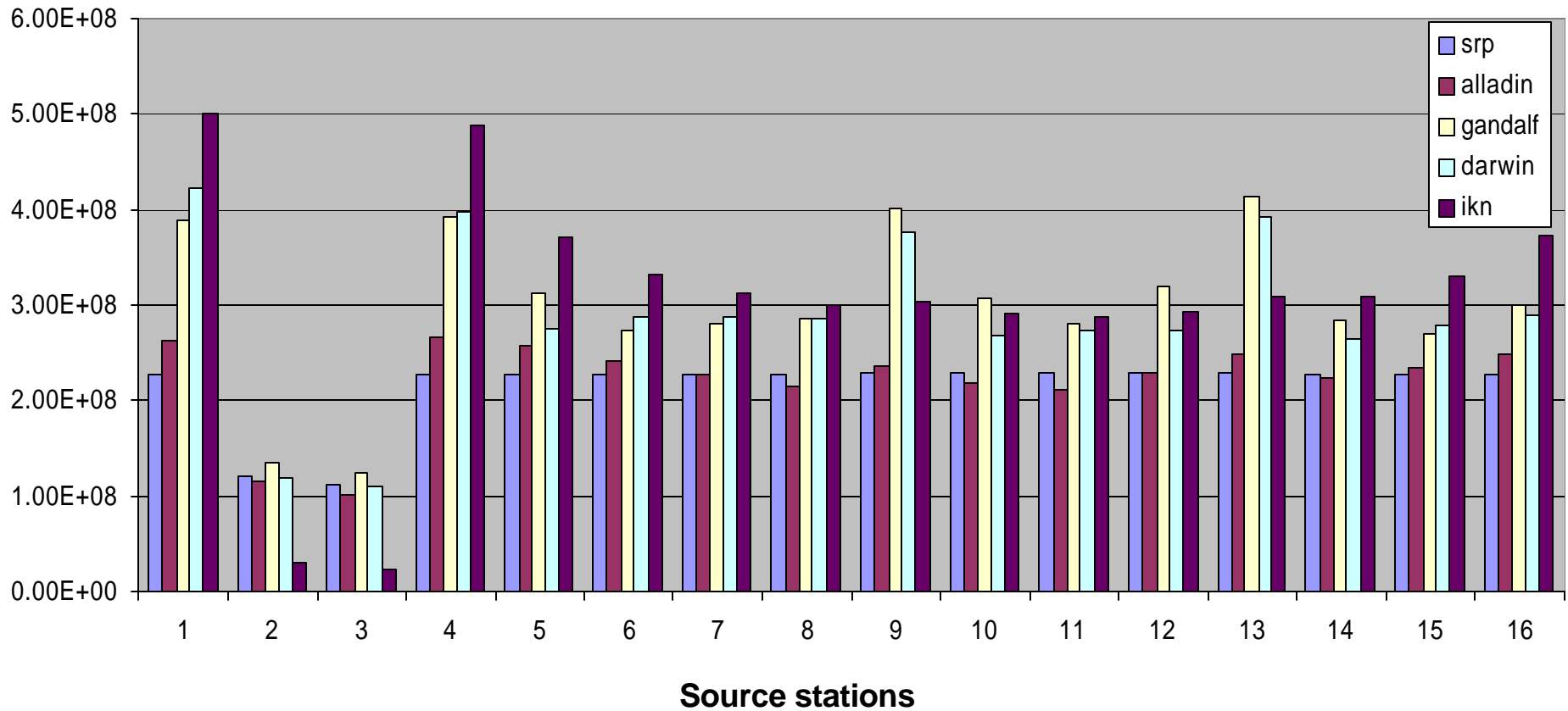

MAC End-to-End Delay

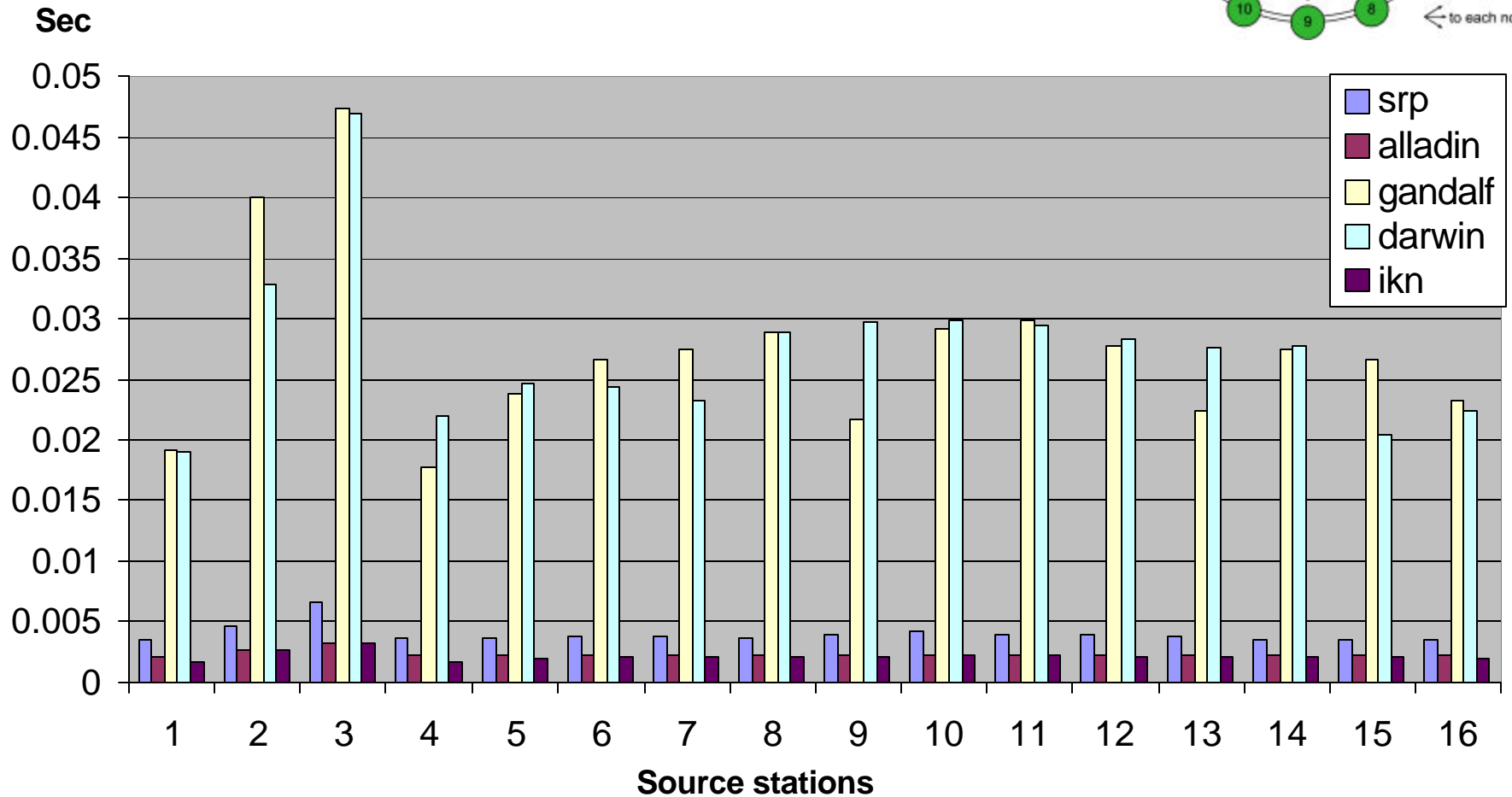
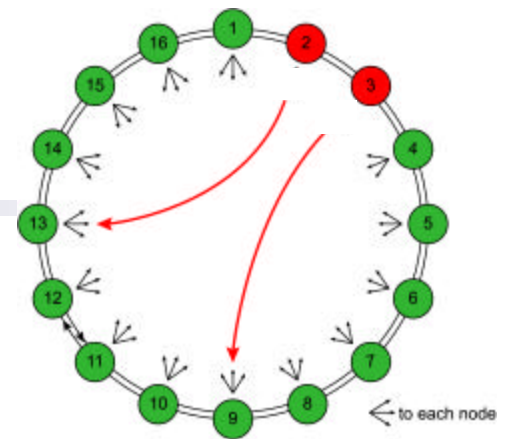

Performance Comparison

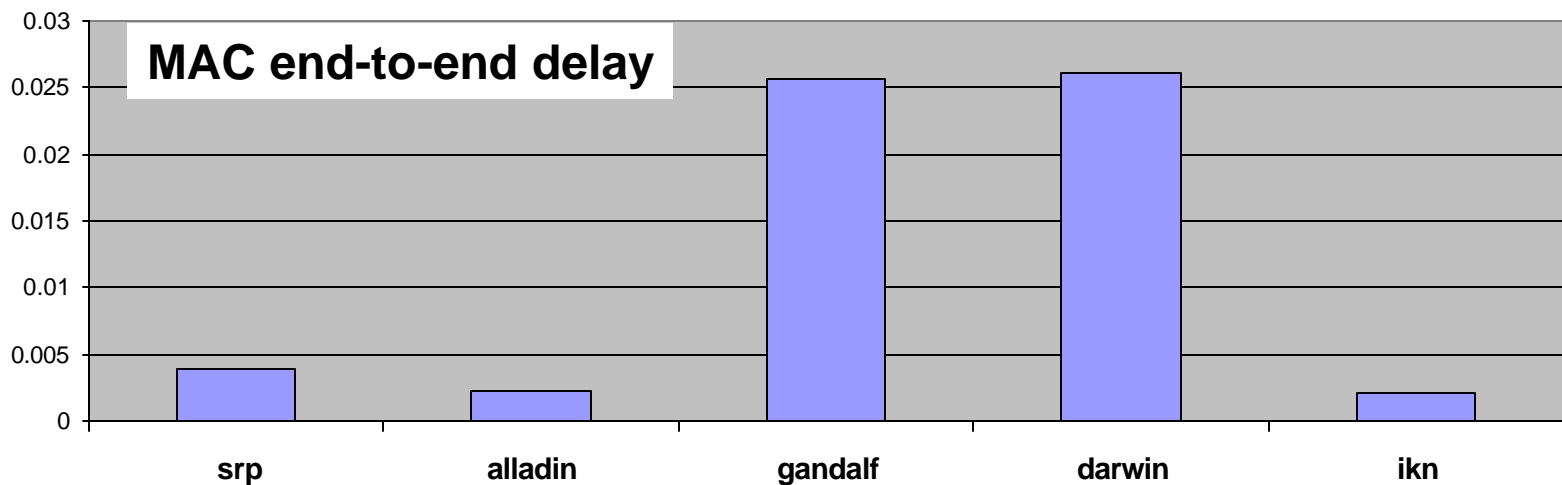
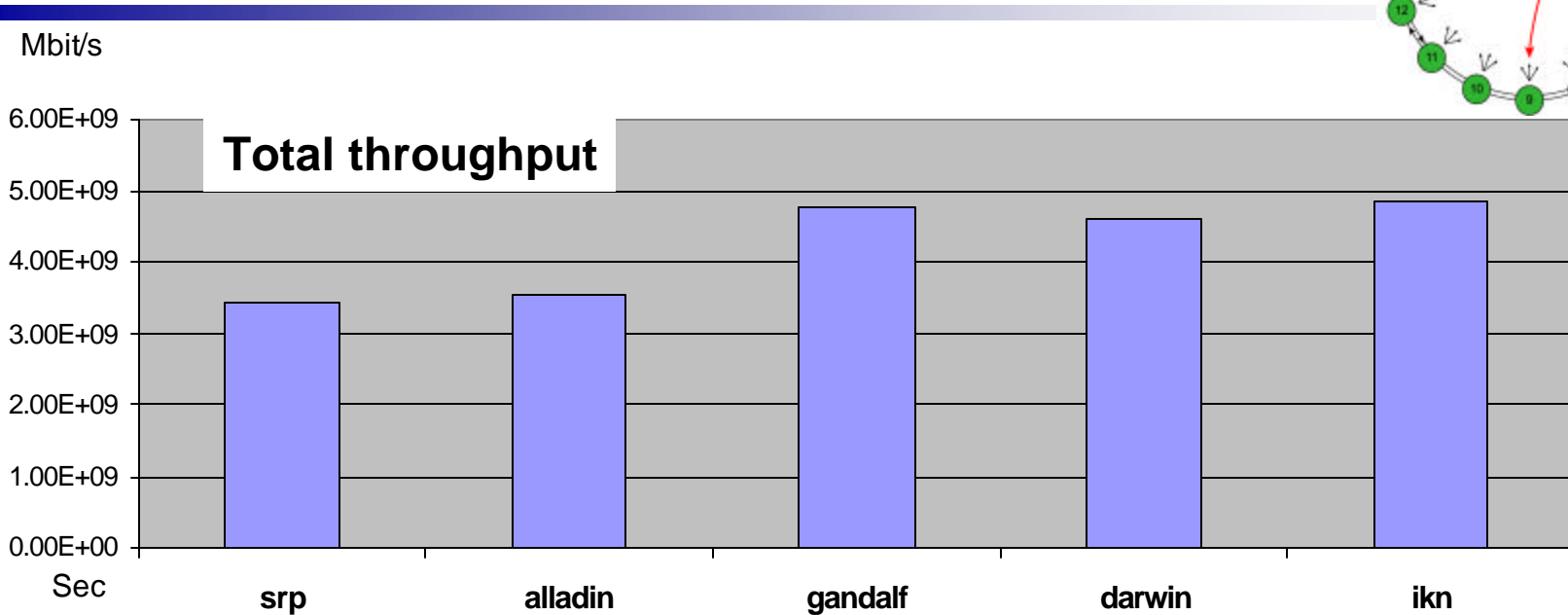
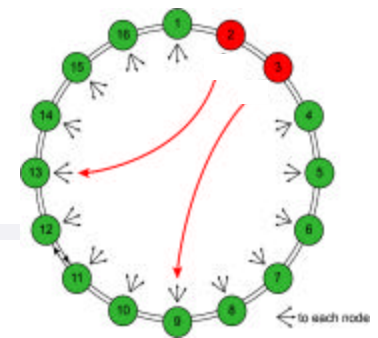

Traffic Scenario 2

OC-12

Ring length: 100 km

Number of stations: 16

Saturated low-priority traffic

500 Byte packet size – exponential

Station **3** sends only to **4** at $t_1 = 0.05$

Station **2** sends only to **4** at $t_2 = 0.1$

Station **1** sends only to **4** at $t_3 = 0.15$

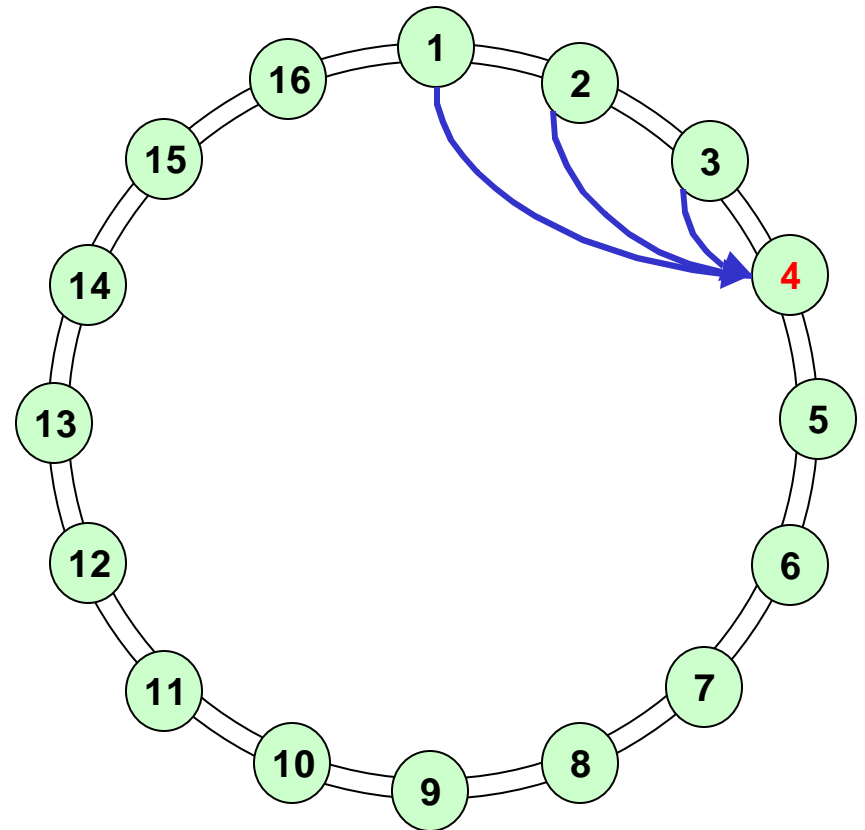

Throughput

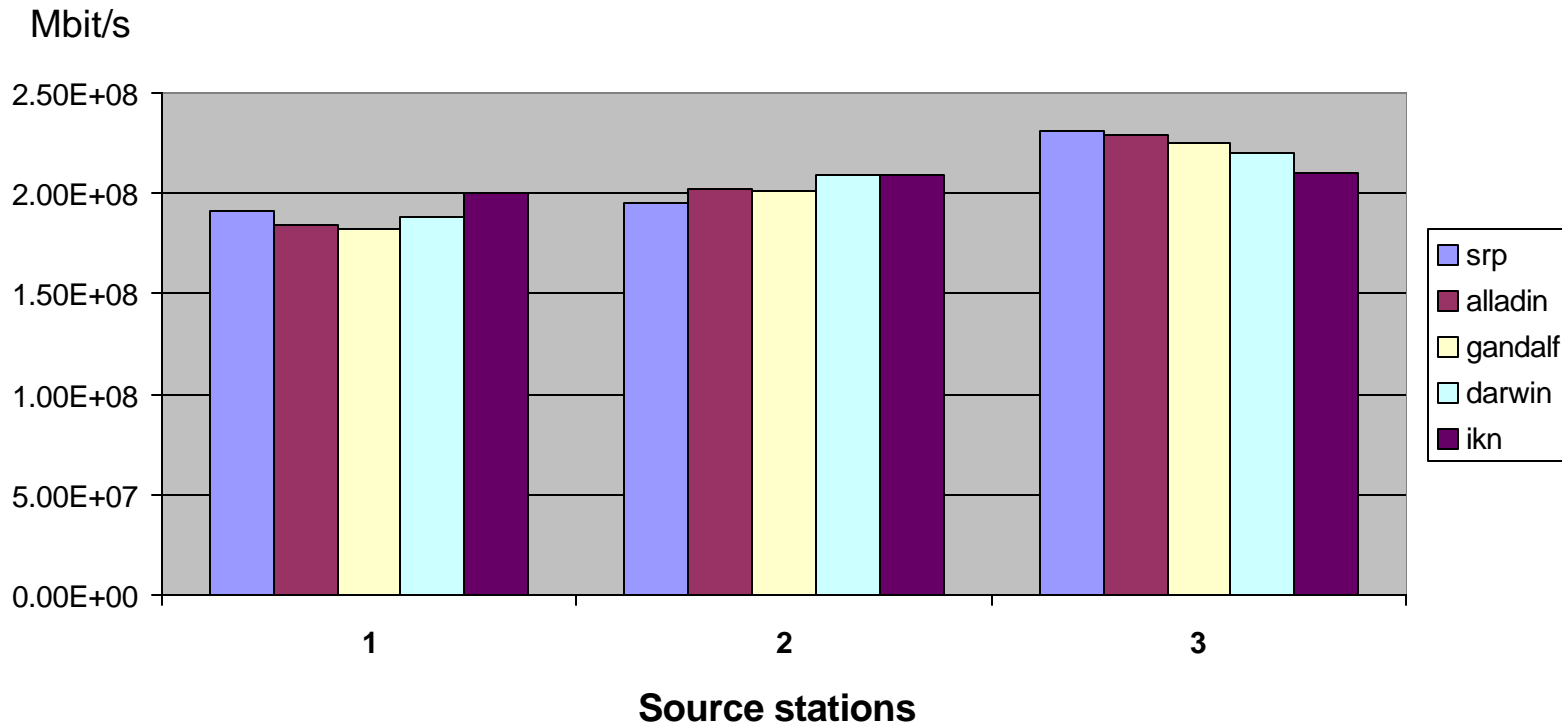
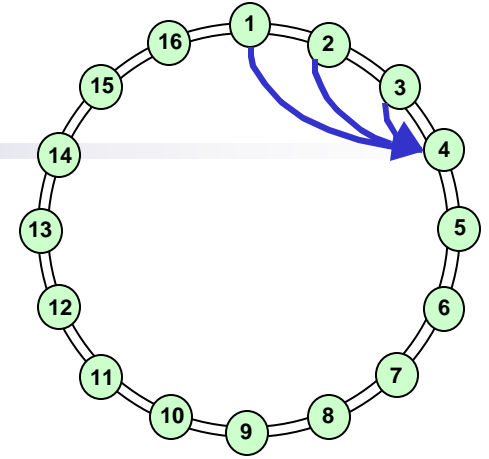

MAC End-to-End Delay

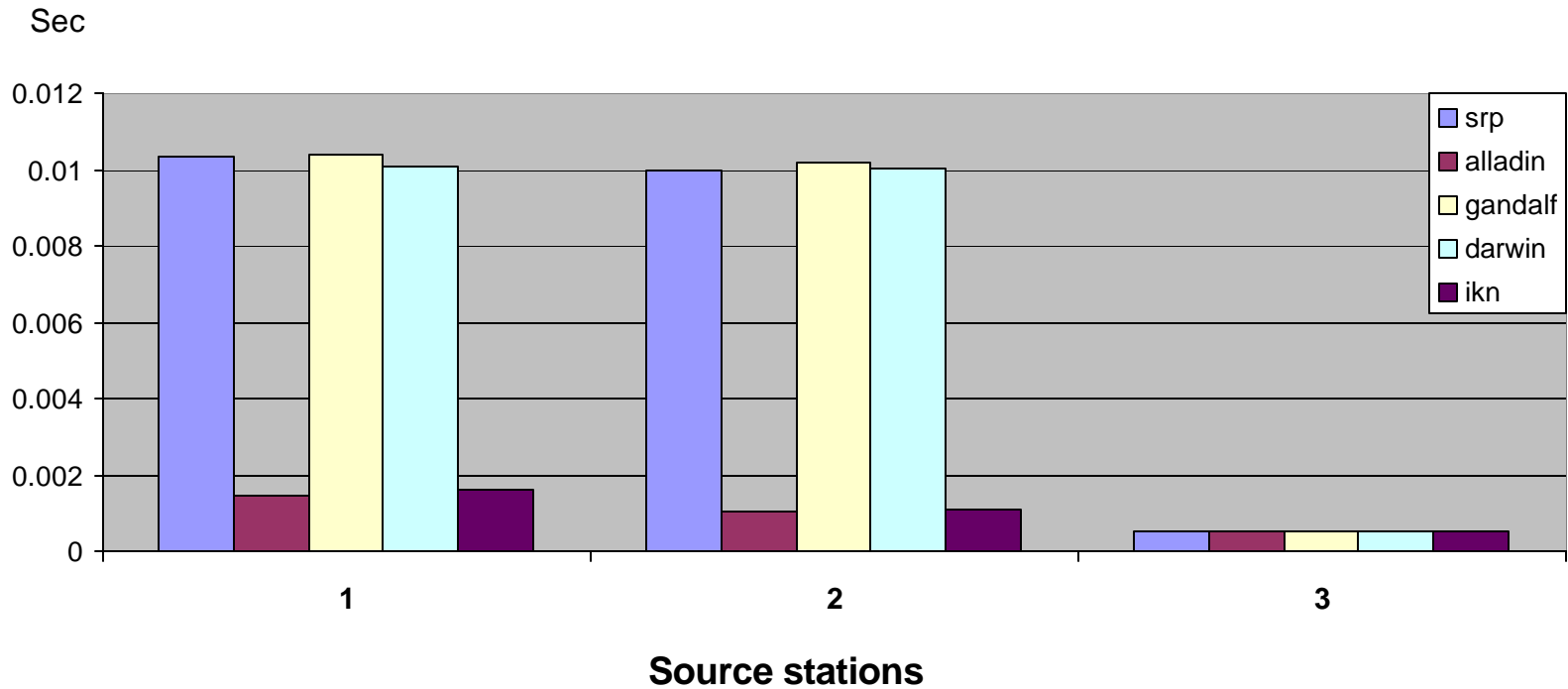
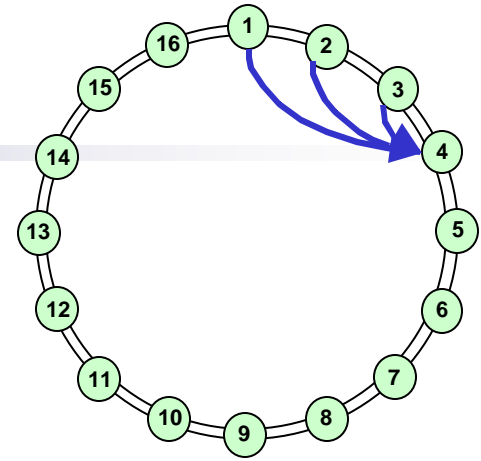

Total Throughput

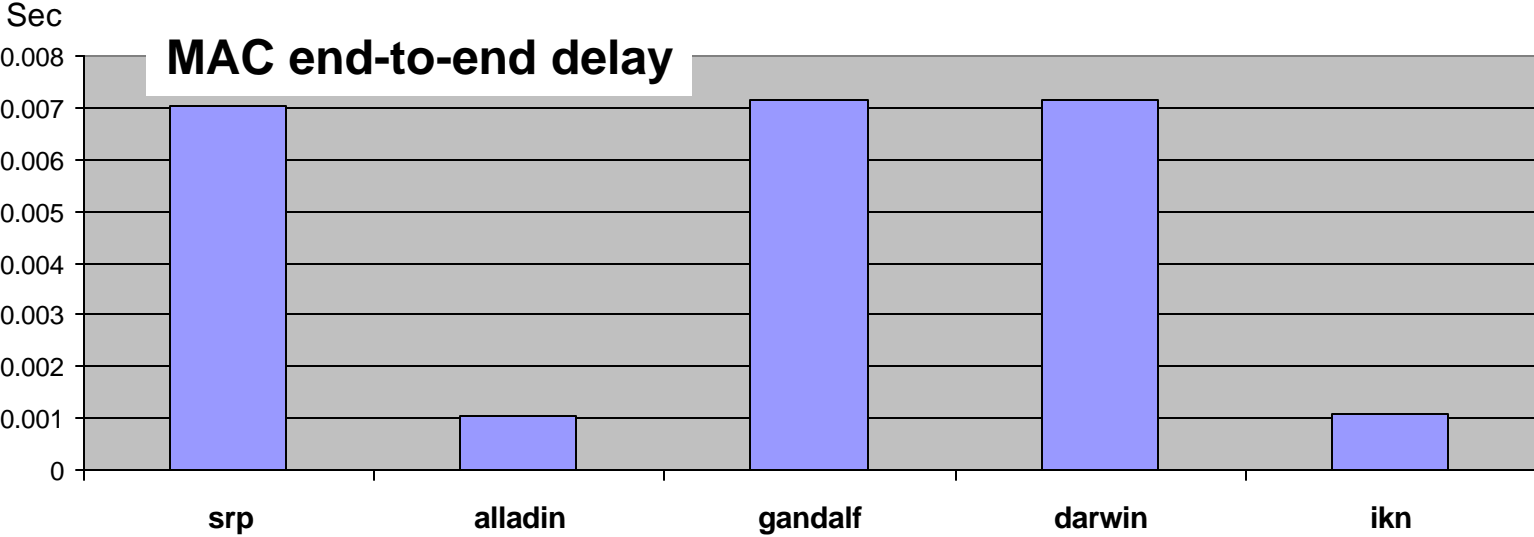
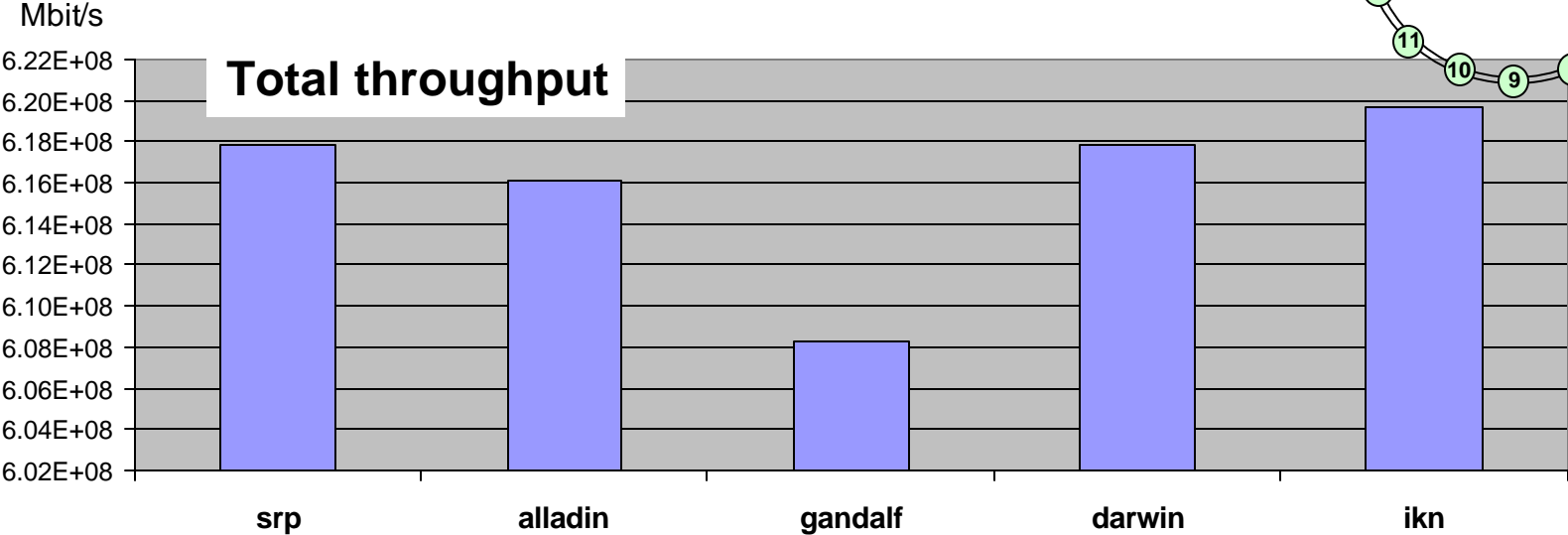
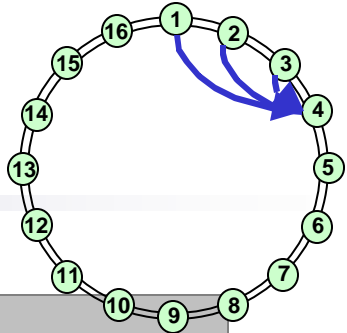

Conclusion

- ① **The Darwin MAC protocol exhibits major weaknesses:**
 - High delays caused by high transit buffer occupancies
 - Best-effort traffic always impacts medium traffic
 - Best-effort traffic impacts high-priority when there is one transit buffer
 - Unfair and strange behavior was observed
 - Parameter setting requires experience and a crystal ball

- ② **Specification of the Darwin MAC protocol:**
 - There are open and unclear points
 - Fairness definition with source flows is unclear and questionable

- ③ **Originators are not too much motivated anymore**
 - to soon specify the protocol clearly and consistently
 - to convince the audience that the protocol works properly