



Backhaul Capacity for Optics for Remote PHY

And answers to questions so far

Fernando Villarruel, Cisco Systems

Michael Eggert, Cox Communications

Harj Ghuman, Cox Communications

Marek Hajduczenia, Charter Communications

For IEEE Ad-Hoc call February 20, 2018

Adding detail to messaging so far...

- Remote PHY and Ethernet
- DWDM, how many wavelengths
- 100G and/or 200G
- Non RPHY services
- Context for OTN
- Context for Cost
- Context for timelines



What is Remote PHY ?

“Remote PHY” is a collection of specifications sanctioned by CableLabs that allows DOCSIS to ride over an Ethernet Network

- CableLabs, MHA v2 Series
 - CM-SP-R-PHY: Remote PHY System Specification
 - **CM-SP-R-DEPI**: Downstream External PHY Interface Specification
 - **CM-SP-R-UEPI**: Upstream External PHY Interface Specification
 - CM-SP-R-DTI: Remote DOCSIS Timing Interface Specification
 - CM-SP-R-OSSI: Operation support Systems Interface Specification
 - CM-SP-R-GCP: Generic Control Plan Specification
 - CM-SP-R-OOB: Out of Band signals Specification

**No new Ethernet requirements.



RPHY Framing

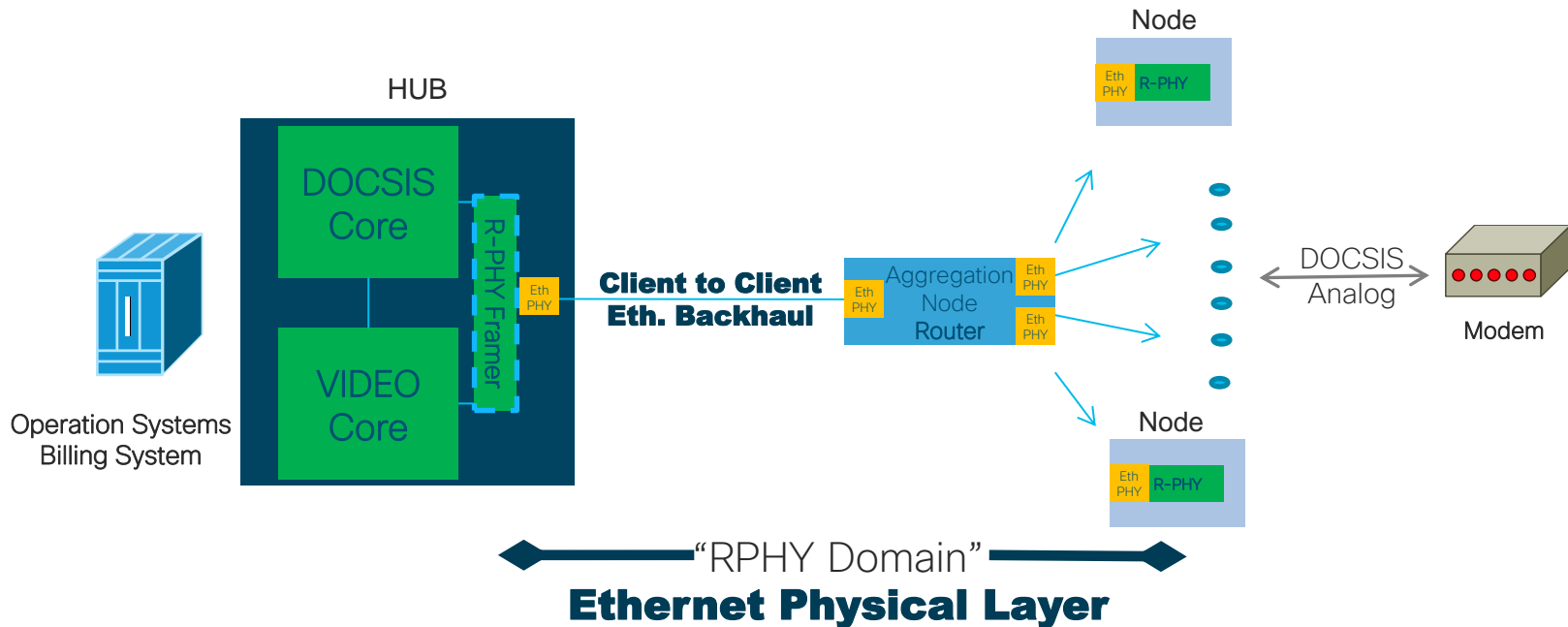
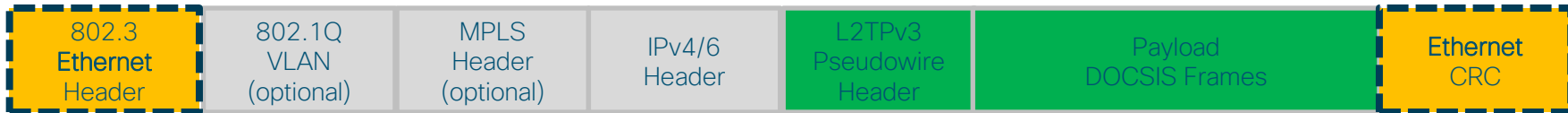

Remote-PHY defines Pseudowires (L2TPV3) that transmit:

- DOCSIS (data traffic)
- Broadcast Video
- and management

within an IP packet and an Ethernet frame.

- Transmitted over Ethernet physical layer
- Ethernet/IP frames make DOCSIS/Video invisible to the network
- no impact to coaxial plant, packet cores, modems & OSS/BSS
- DOCSIS data makes up the bulk of the payload volume
- Allows a multivendor interoperable environment.

A note on Service Cores

- DOCSIS and Video cores organize and distribute a bandwidth availability per the policy given by Operation and Billing systems. (OSS/BSS)
 - DOCSIS data is unique per service group.
 - Video can be unique per service group or the same for two or more service groups.
 - When video is the same for all service groups we call it broadcast – Fox, CBS, NBC, etc.



Remote PHY Backhaul

Physical vs. logical functions

R-PHY Physical Distribution

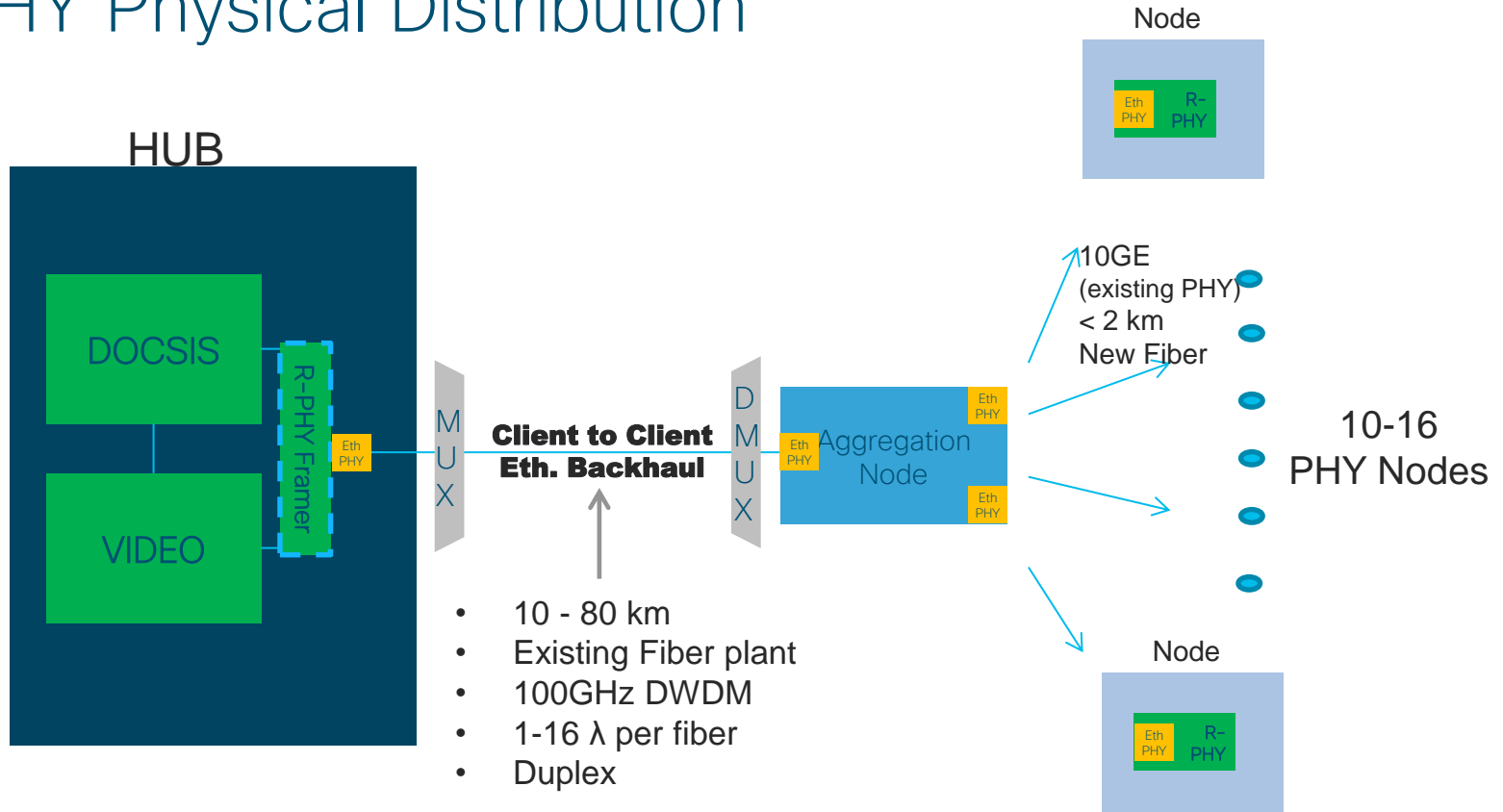

Logical Distribution

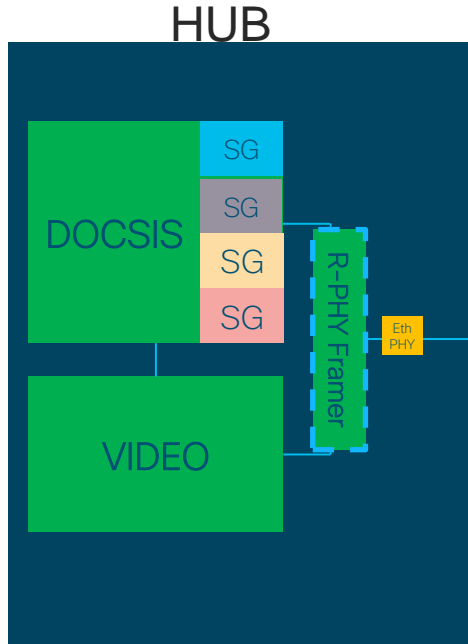

**Client to Client
Eth. Backhaul**



- ~200 Subscribers / service group (SG)
- Broadcast video
 - one video SG for all.
 - Unicast video considered data carried by DOCSIS.

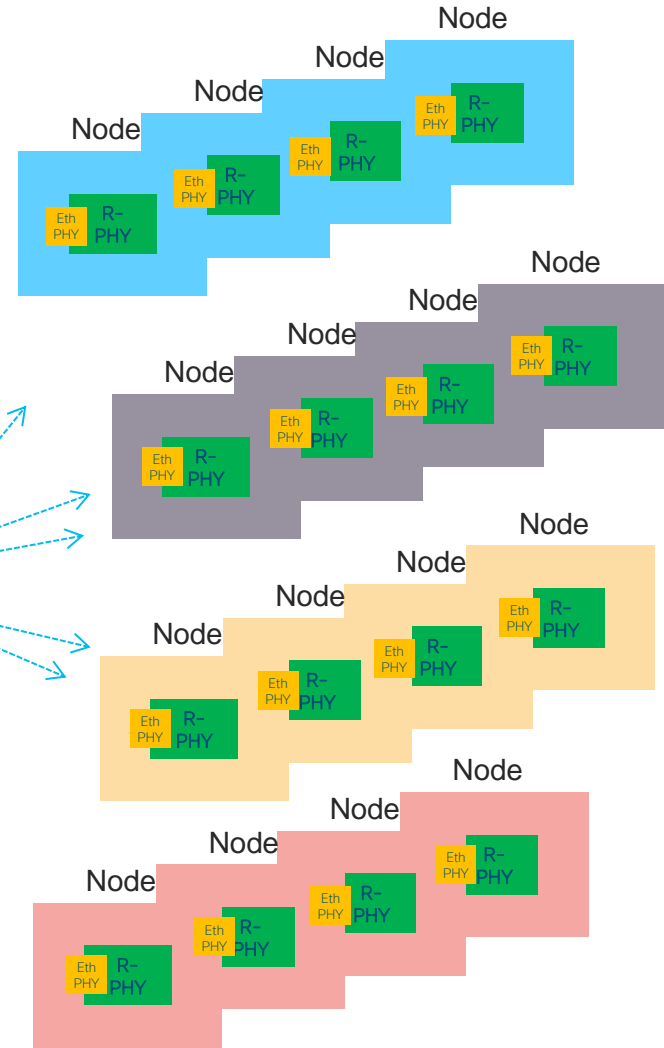

What is the capacity
needed for the Remote PHY
Ethernet Backhaul?

Client to Client R-PHY Backhaul Capacity

- Single direction capacity- download
- Router in Agg Node servicing:
 - 16 PHY Nodes
 - 4 or 8 PHY nodes per DOCSIS service group
 - Compounded annual growth rate CAGR 40% DOCSIS Data
 - Static 1.25 Gpbs Broadcast video
- Broad Market View
 - United States (US) SG start at 3 Gbps
 - Lating America / Europe (Latam/EU) start at 1 Gbps
- Start in 2019 because most capacity has already been purchased until then.

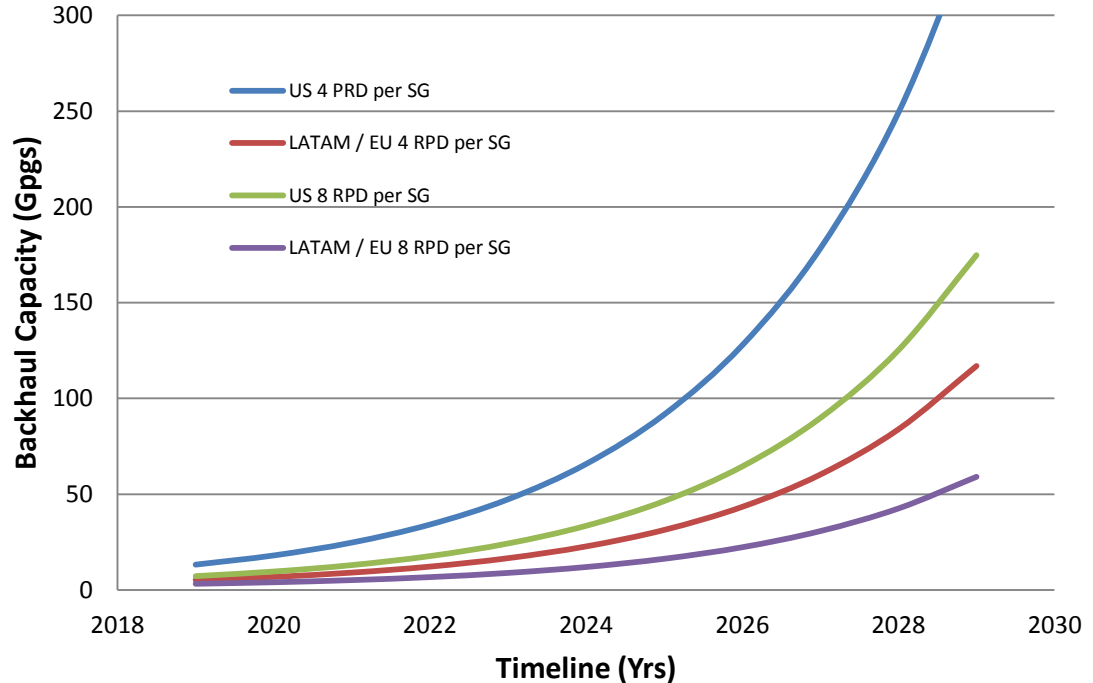

Backhaul Optics Planning

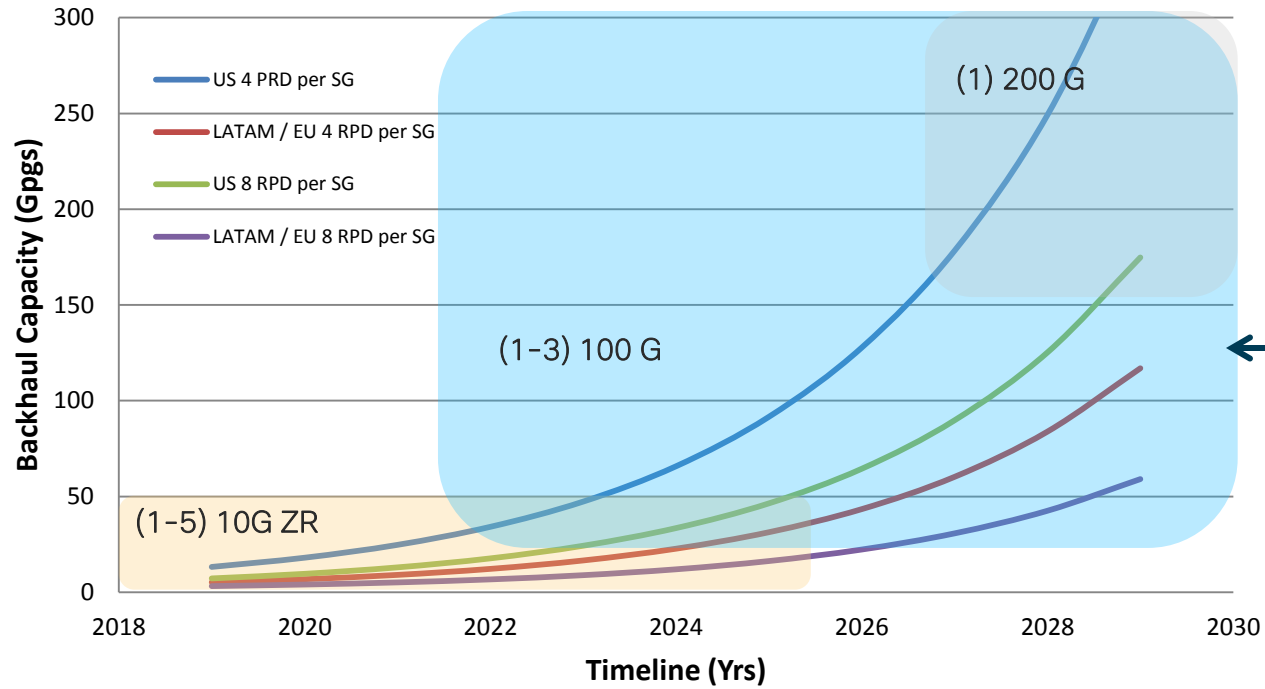

- 100G DWDM Ethernet PHY needed to make this transition
- Leverage mature technology

Backhaul Optics Adoption Timelines

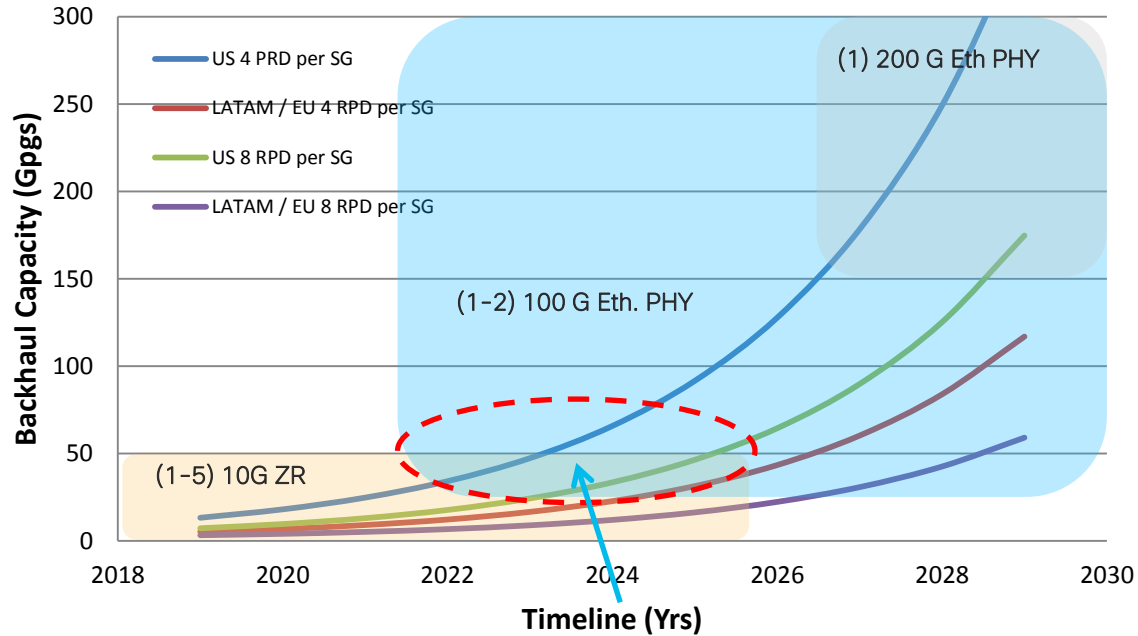

- Adoption time frame is dependent on cost delta between 1-5 10G DWDM ZR to 100G DWDM optics
- Early deployments with DWDM 10G ZR, quickly exhaust fiber capacity.

100G client (Ethernet) specification is needed today to enable RPHY is full scale deployments.

- 100G PHY standard is necessary now. Routers must be installed day one with capability to grow to 100G backhaul.
- note, 200G is also useful, but 100G is the high volume runner with expected robust cost reductions.

What about other services' impact on backhaul ?

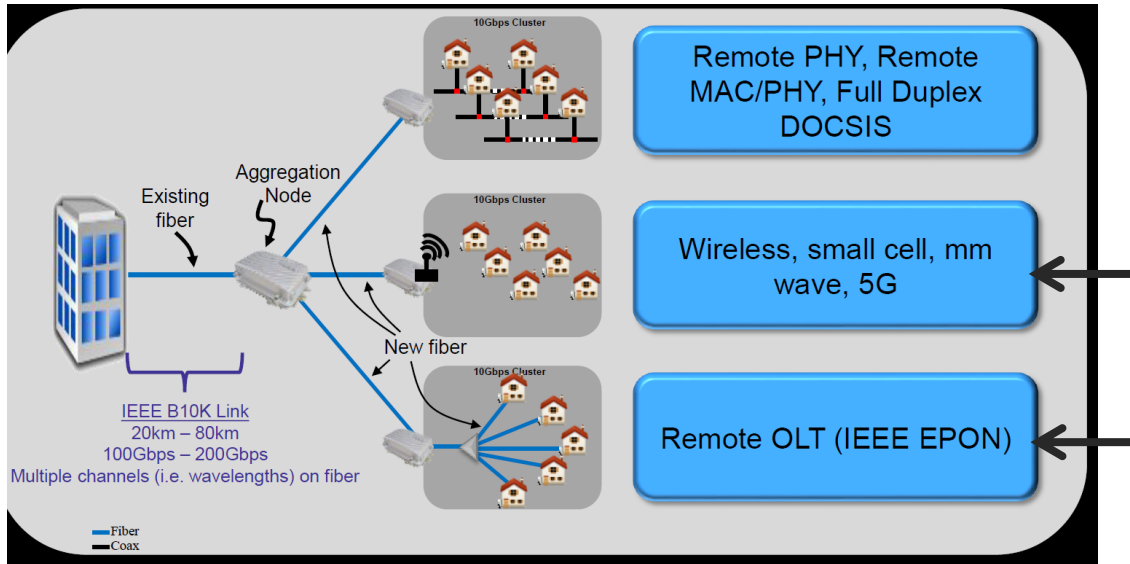

See: http://www.ieee802.org/3/B10K/public/18_01/knittle_b10k_01_0118.pdf

- Unicast.
- Terminate at multiple packet cores.
- 12-18, 10G downlinks
- 200G useful
- Don't have to use a router could use an (OTN) Muxponder at aggregation node
- A minority of links compared to R-PHY.

- Available today
- In definition and CableLabs and this study group
- Proprietary solutions

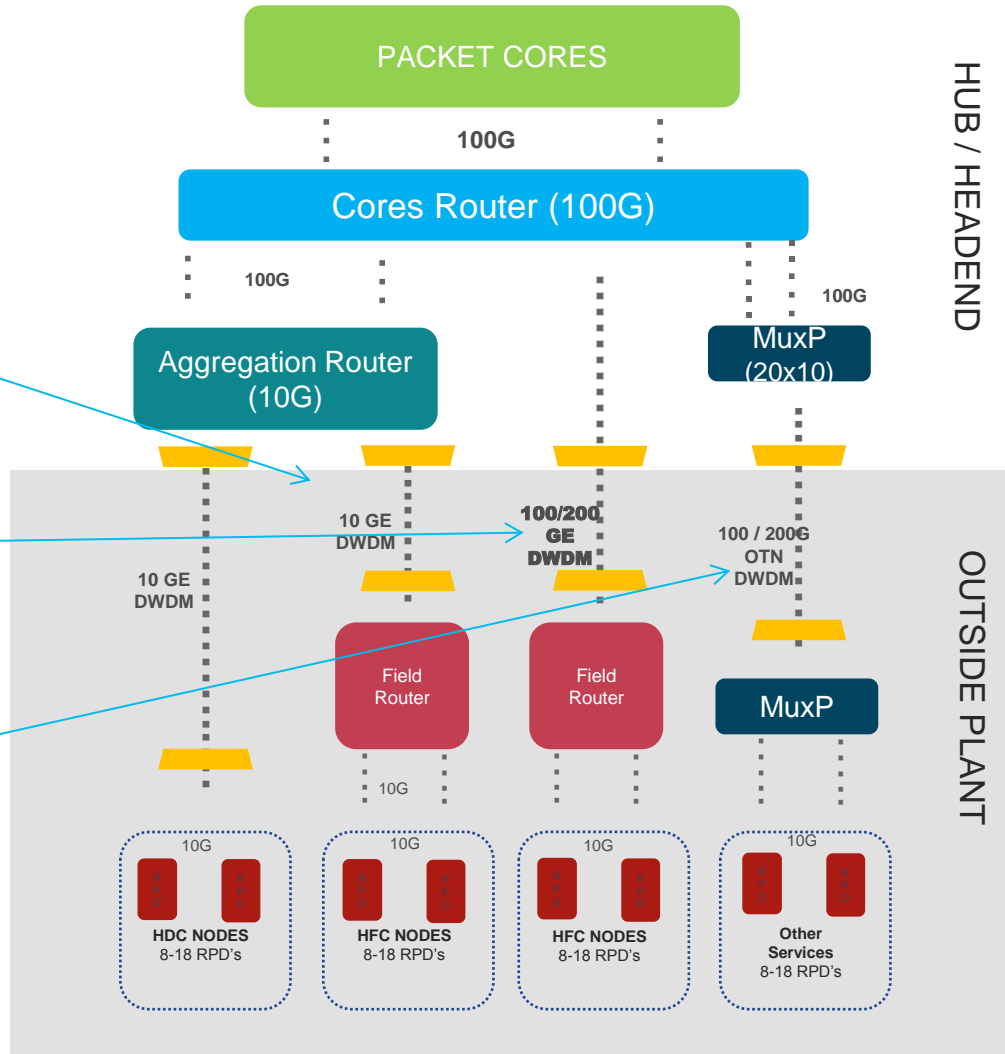

Added detail to messaging so far...

- Remote PHY and Ethernet
- DWDM, how many wavelengths
- 100G, 200G
- Other services
- Context for OTN
- Context for Cost
- Context for timelines

Oh...Now I get it

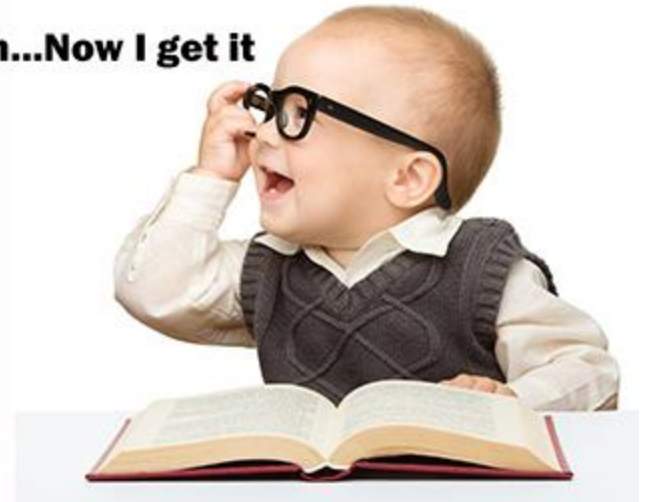



Backhaul Optics for Remote PHY

Answers to questions so far

Fernando Villarruel, Cisco Systems

Michael Eggert, Cox Communications

Harj Ghuman, Cox Communications

Marek Hajduczenia, Charter Communications

For IEEE Ad-Hoc February 20, 2018