

RSOFT

Design Group

*Full Spectrum Photonic and
Network Design Automation*

Multimode Fiber Communication System Simulation

[Gary Shaulov](#), Brent K. Whitlock

RSoft Design Group, Inc.
200 Executive Blvd.
Ossining, NY 10562

www.rsoftdesign.com
gary@rsoftdesign.com, 914-923-2164

IEEE 802.3aq Portland July 2004

Introduction

- TIA standards development for laser optimized multimode fiber (TIA/EIA-492AAAC) required new modeling and simulation approaches. RSoft participated in TIA working group on modal dependence of multimode fiber bandwidth since 2001 and developed tools to address TIA needs
- These tools have been validated and are now used by industry
- RSoft Design Group is participating in IEEE 802.3aq 10GBASE-LRM Task Force to help Ethernet community with developing new standards and to better understand the current industry needs and requirements
- Our objective is to use our multimode fiber simulator to address Channel Modeling ad-hoc discussion topics such as fiber modeling, studying launch conditions, time-varying effects, reproducing of and comparison with Cambridge model and Monte-Carlo model results.
- Here we present some results of our initial studies
- This work has been supported by a Navy SBIR contract (through Gair Brown of the Naval Surface Warfare Center) and a NIST ATP contract (through the PCAD Consortium)

Requirements for Multimode Simulation

- Model and simulate spatial characteristics of multimode fiber
 - Modal and chromatic dispersion
 - Differential Mode Delay (DMD)
 - Mode coupling coefficients, mode power distribution (MPD)
 - Polarization
- Model modal fields of multimode components. Laser output beams can be modeled with different mode compositions to provide single-mode, restricted-mode, or overfilled launch with Gaussian, LG, HG, LP, donut spatial profiles, or any of their combinations
- Model a coupler/connector with 3D coupling into and out from fiber
 - x , y , z offsets, angular offsets, plus polarization
- Model and simulate encircled flux (EF)
- Model and simulate effective modal bandwidth (EMB)
- System simulation to also flexibly and accurately model other system components including lasers and receivers taking transient behavior, nonlinearities, and noise into account
- Take temporal and modal characteristics into account for total system simulation performance including signal to noise ratio, BER, signal waveforms, eye diagrams, power penalties, etc.

Multimode Fiber Model – Our Approach

- Fiber refractive index profile used to accurately calculate modes and delays
- Index profile can be defined analytically, by numerical file, by functional representation, or by power-law parameter
- Helmholtz equation solved numerically by simulator

$$\frac{d^2 E(r)}{dr^2} + \frac{1}{r} \frac{dE(r)}{dr} + \left[n^2(r) k_0^2 - \beta_{LM}^2 - \frac{L^2}{r^2} \right] E(r) = 0$$

$$E(r, \phi, z) = E(r) \cdot \exp(jL\phi) \cdot \exp(j\beta z)$$

- For a given azimuthal index L , the mode solver will generate solutions for each radial index M .
- Mode power distribution (MPD) calculated through overlap integration
- Outputs from fiber model include delay plots, coupling coefficients for each mode and for Degenerate Mode Groups

Multimode Fiber Model – Cont'd

Modal Delays

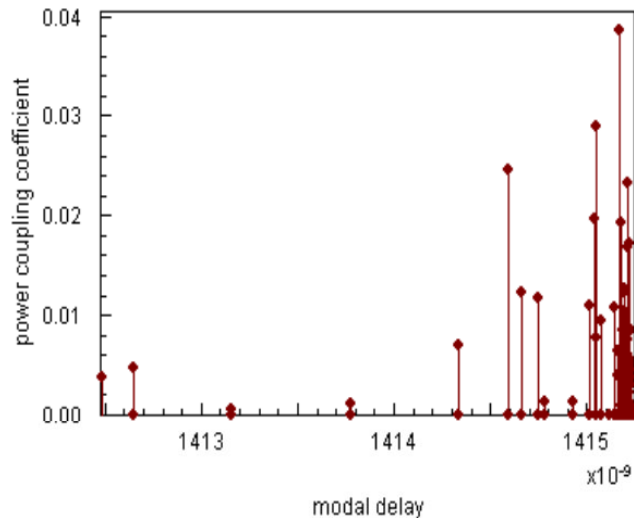

Coupling Coefficients

$$E_{input}(x, y) = \sum_{i=1}^n c_i E_i(x, y)$$
$$c_i = \iint E_{input}(x, y) E_i^*(x, y) dx dy$$

Representative Fiber Modes

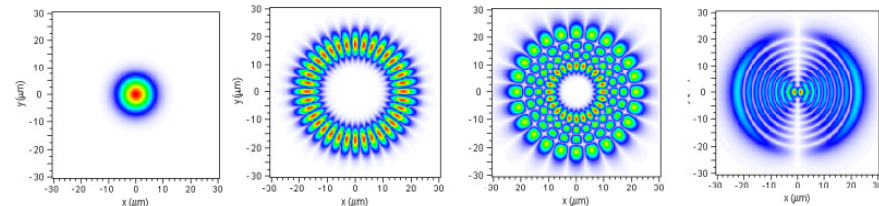

- Both modal and chromatic dispersion are modeled. Chromatic dispersion can be either specified or calculated according to formula:

$$D(\lambda) = \frac{S_0}{4} \lambda \left[1 - \frac{\lambda_0^4}{\lambda^4} \right]$$

Refractive Index Perturbations

- We consider the index profile with perturbations as specified in Cambridge model

$$n(r) = \begin{cases} n_1 \cdot \left(1 - 2\Delta \left(\frac{r}{a}\right)^\alpha\right)^{1/2}, & \text{core, } r \leq a \\ n_1 \cdot (1 - 2\Delta)^{1/2} = n_2, & \text{cladding, } r > a \end{cases}$$

Four types of defects are included:

- Inner core α {1.89, 1.97, 2.05}
- Outer core α {1.89, 1.97, 2.05}
- Center defect – none, tip, dip
- Core/cladding defect – none, sudden, exponential

Total of 81 combinations

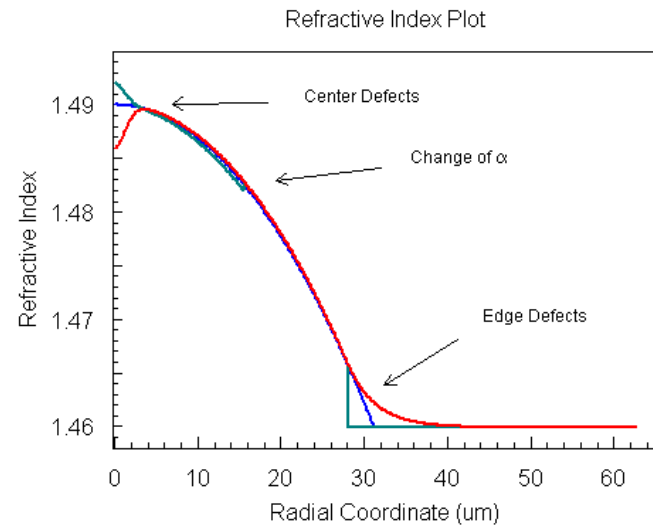

FDDI-grade fiber:

62.5/125 μm

$n_1=1.49$, $\Delta=0.02$

- supports 253 modes
and 22 degenerate mode
groups

Impulse Responses and Modal Bandwidth

- A schematic to study impulse response and MB is shown on the right
- Launch signal is 50-ps Gaussian with 7 μm FWHM for RML or can use overfilled launch profile calculated by fiber model
- Operational wavelength 1300 nm
- Fiber is 300 m long with chromatic dispersion set to zero
- Coupler allows the radial and angular offset of the launch signal

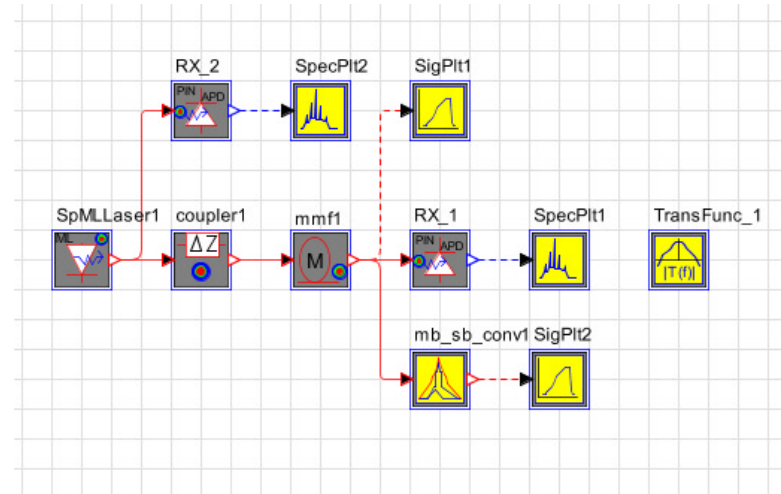

We generated a library of index profiles for 81-models for given fiber parameters (diameter, peak index, index step) and perturbation parameters. These index profiles (*index1.ipf, index2.ipf, ..., index81.ipf*) are used as input files in simulator.

Two typical index distortions

- We studied just two different perturbed index profiles out of 81, one with a tip in the center, and the other one with a dip.
- The first one is fiber #23 – has a tip, alpha change, and sudden edge defect
- The second one is fiber #81 - has a dip and exponential edge defect

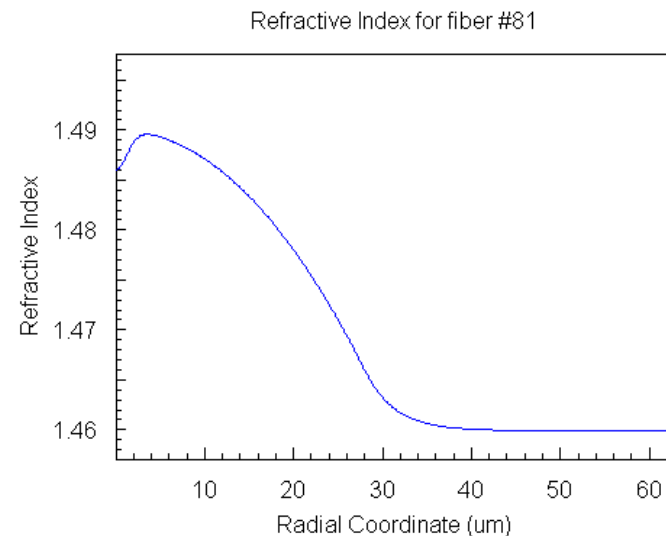
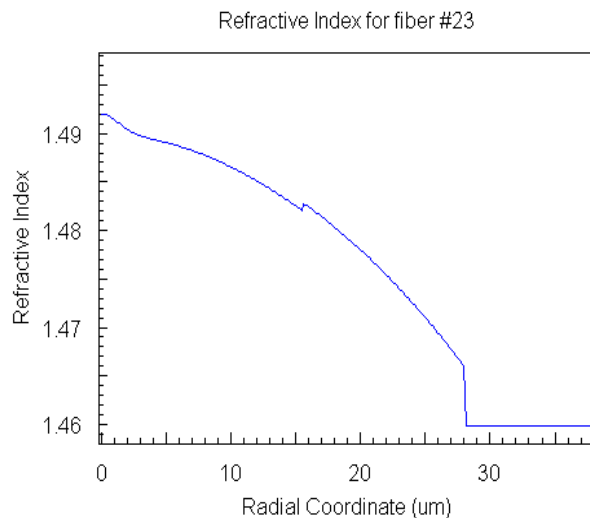

Note: Fiber model numerations here are different from those used in Cambridge model

Fiber #23 – Impulse Responses and Mode Delays

- Modal delays and impulse response at offset = 0, 4, and 20 μm

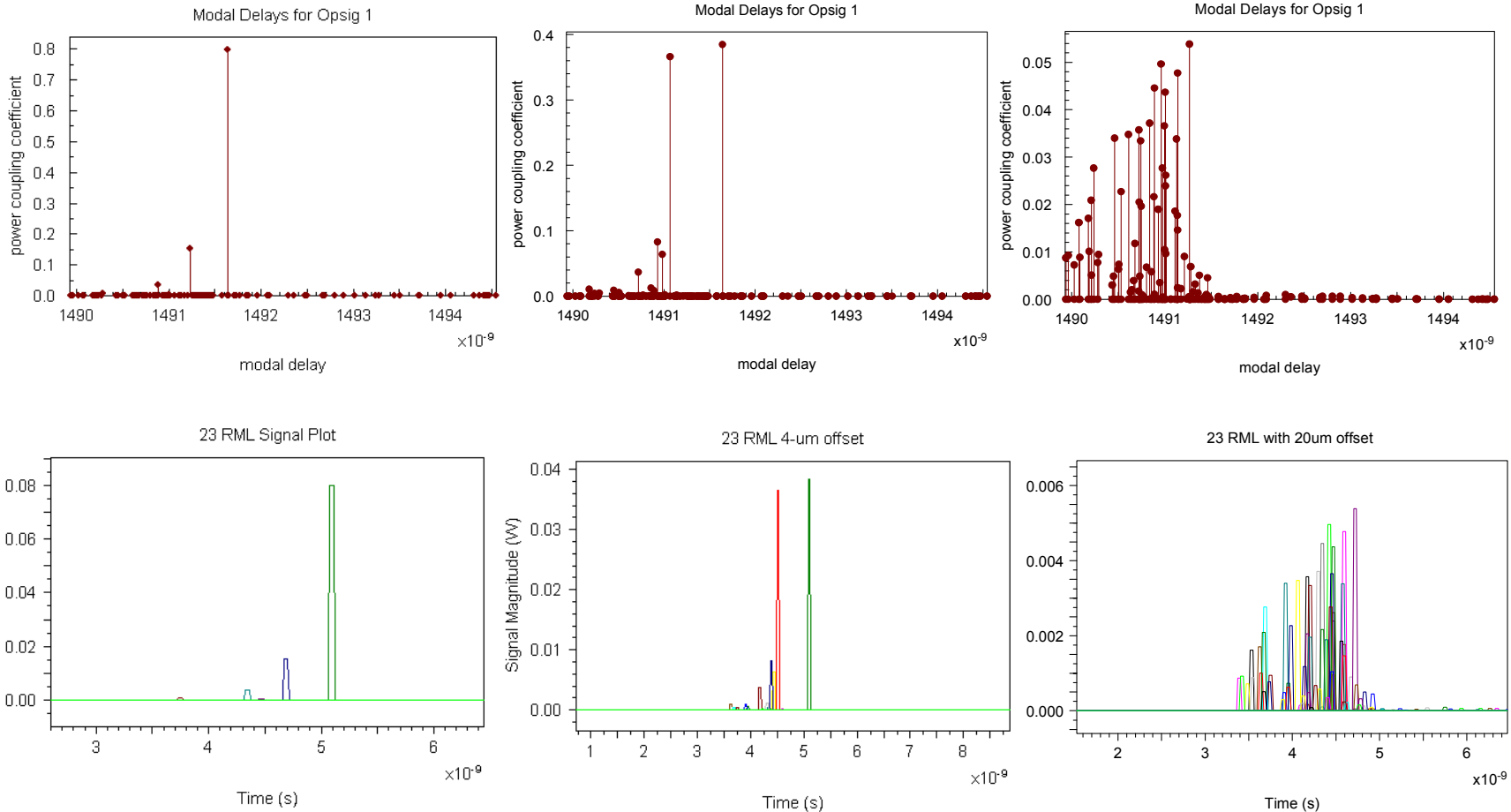

Fiber #23 – overfilled launch

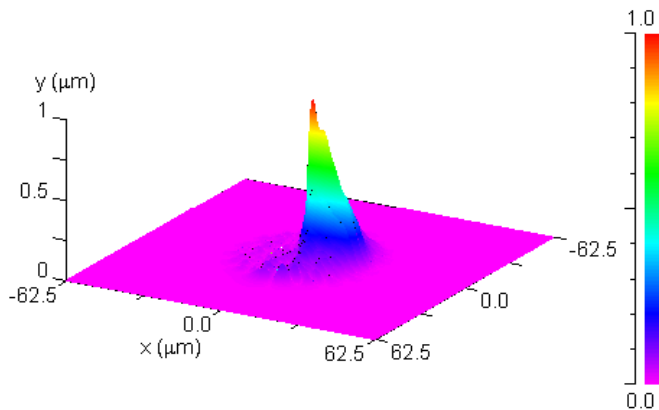
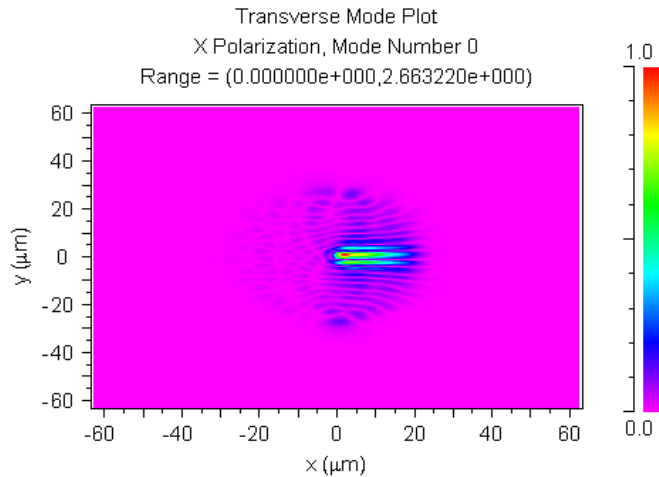

- On the left – mode field for overfilled launch (contour and 3D plots)
- On the bottom – mode delays for overfilled launch – all modes are equally excited

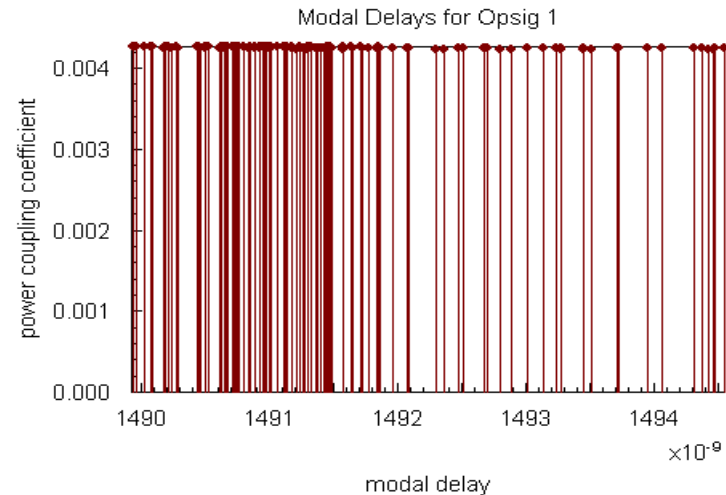

Fiber #23 - DMD

- DMD is calculated according to TIA/EIA-455-220 definition

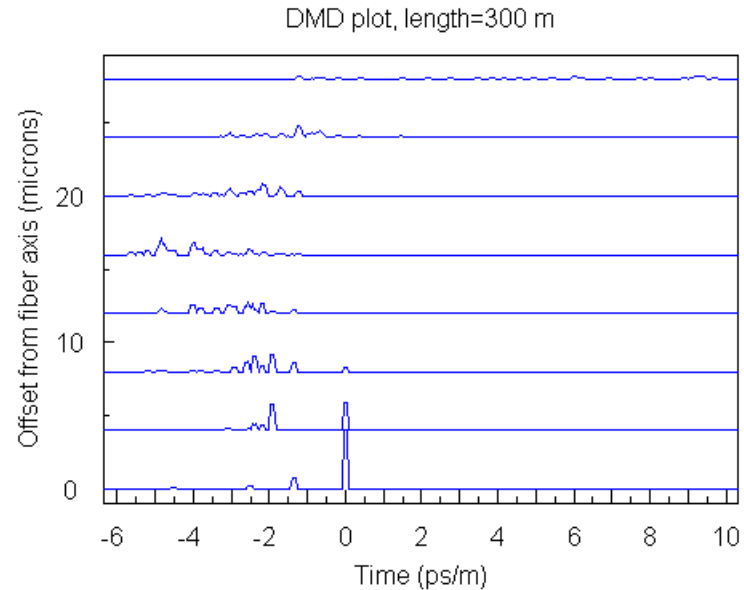
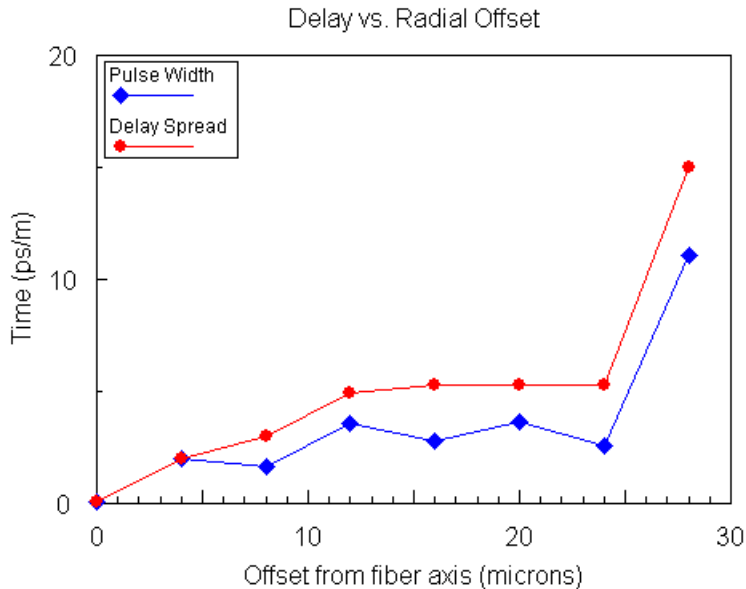

Fiber #23 – Modal Bandwidth

- Frequency response (transfer function) for 0-, 4-, 20- μm offset RML, and OFL launches after 300 m

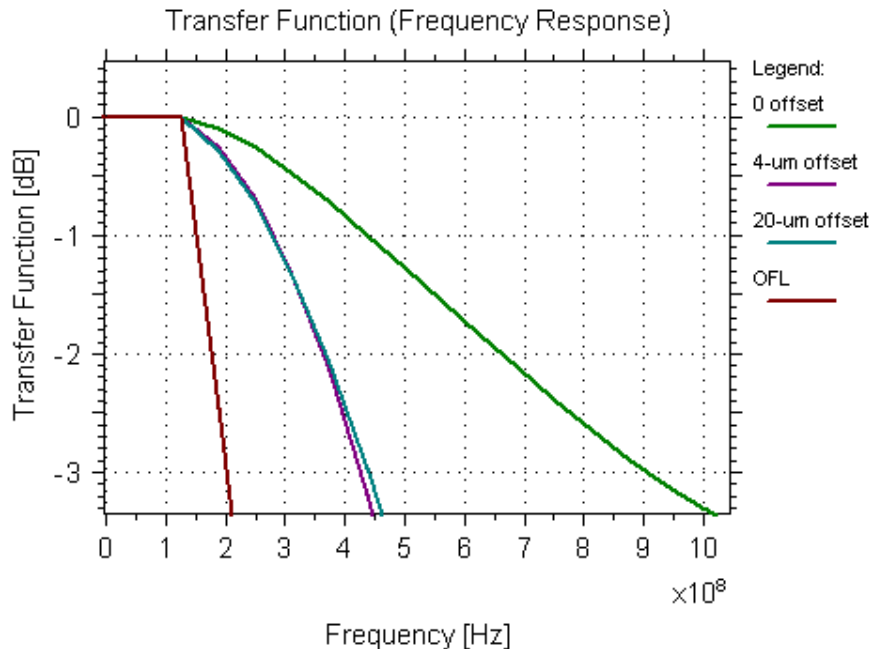

Modal Bandwidths:

- RML 0-offset – 270 MHz \cdot km
- RML 4-um offset – 130 MHz \cdot km
- RML 20-um offset – 135 MHz \cdot km
- OFL – 60 MHz \cdot km

Note: We did not apply here DMD scaling to 2 ps/m as in Cambridge model

Fiber #81 – Impulse Responses and Mode Delays

- Modal delays and impulse response at offset = 0, 4, and 20 μm

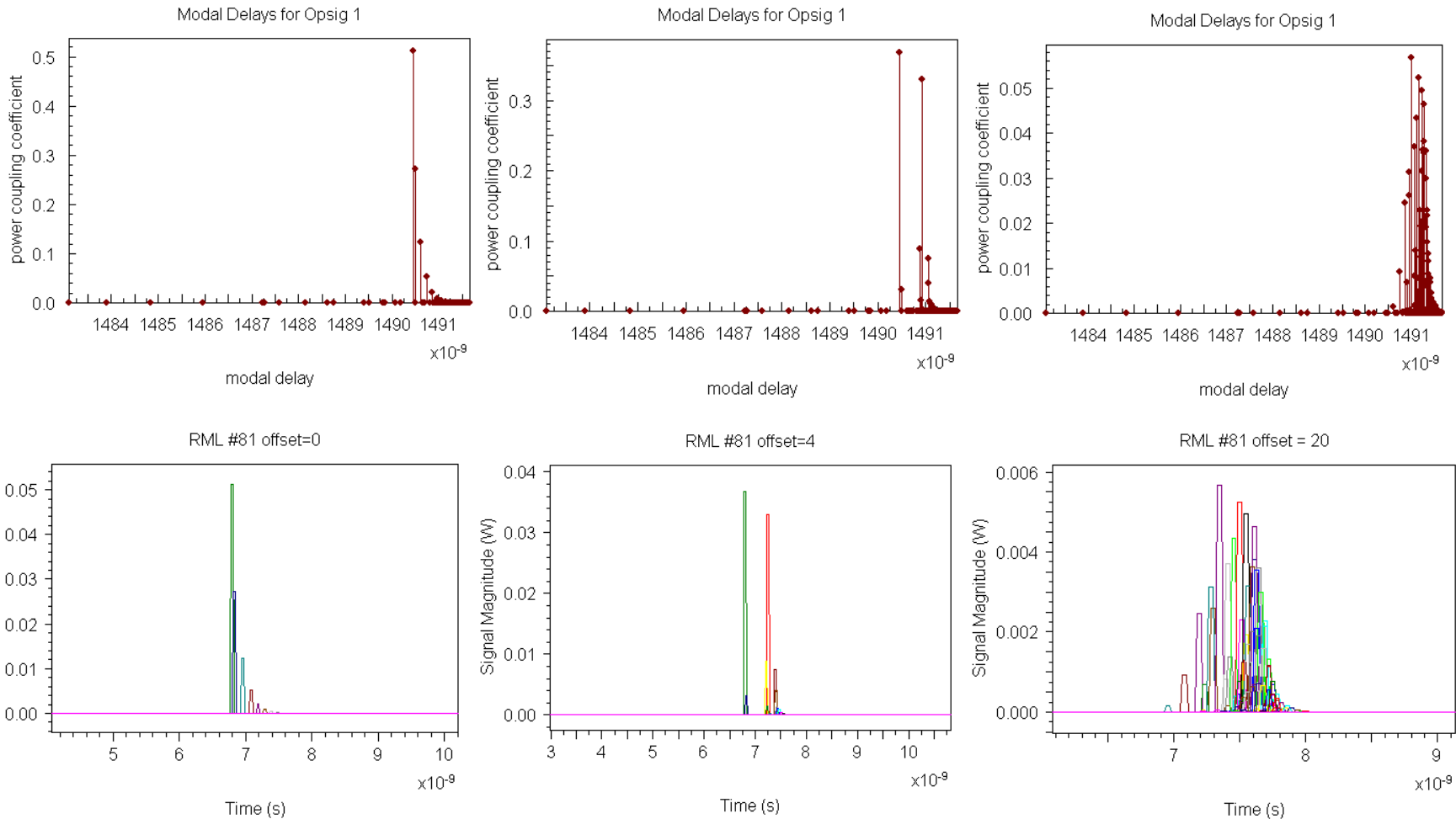

Fiber #81 - DMD

- DMD is calculated according to TIA/EIA-455-220 definition

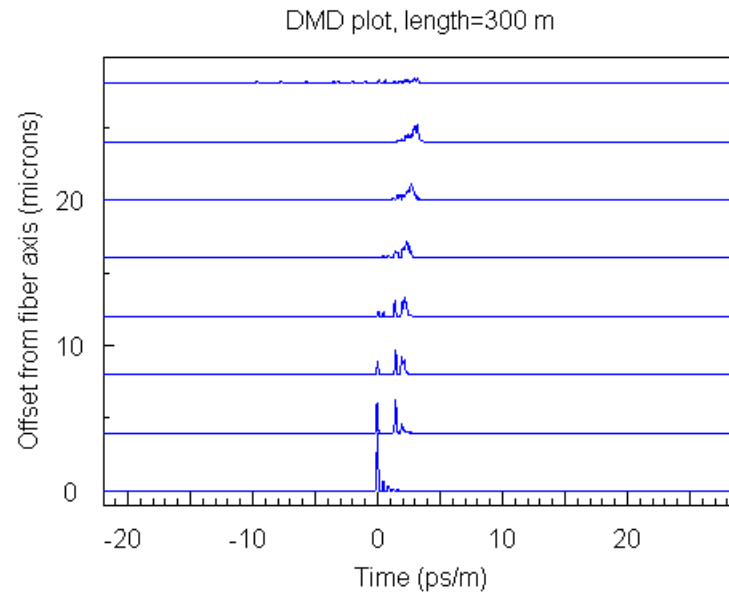
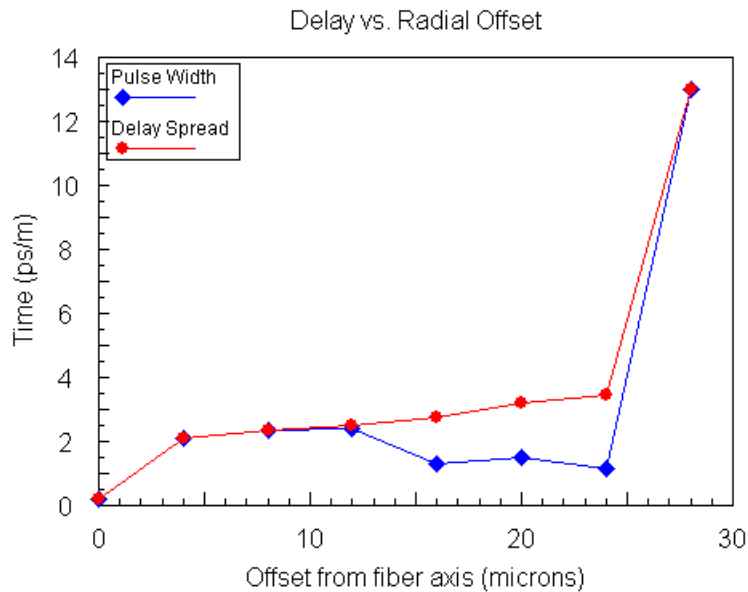

Fiber #81 – Modal Bandwidth

- Frequency response (transfer function) for 0-, 4-, 20- μm offset RML, and OFL launches after 300 m

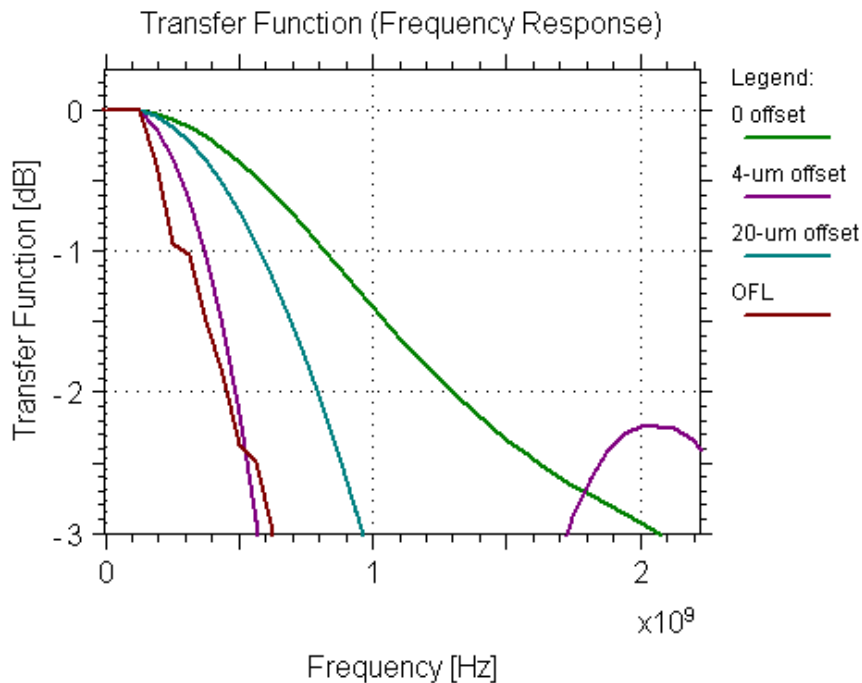

Modal Bandwidths:

- RML 0 offset – 600 MHz \cdot km
- RML 4- μm offset – 170 MHz \cdot km
- RML 20- μm offset – 290 MHz \cdot km
- OFL – 190 MHz \cdot km

Note: We did not apply here DMD scaling to 2 ps/m as in Cambridge model

Eye Diagrams

- MB and DMD only provide part of the information necessary to determine whether link failures are likely to occur.
- In order to assess system performance metrics such as BER and eye opening, one has to simulate fiber response to modulated signals.

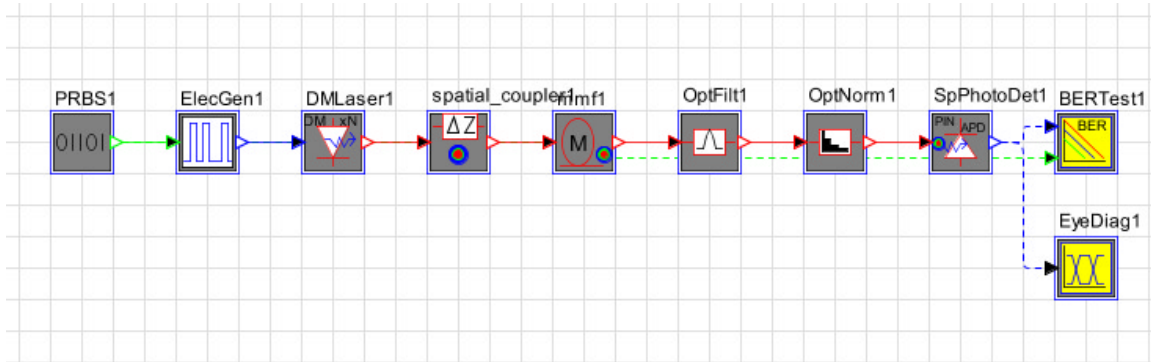

Schematic used to study case of 1 Gb/s NRZ-modulated signal

- Input signal is Gaussian fundamental mode with 7 μm FWHM
- BER and eye diagrams for fibers #23 and #81 were studied at different launch offsets

Eye Diagrams and BER for fiber #23

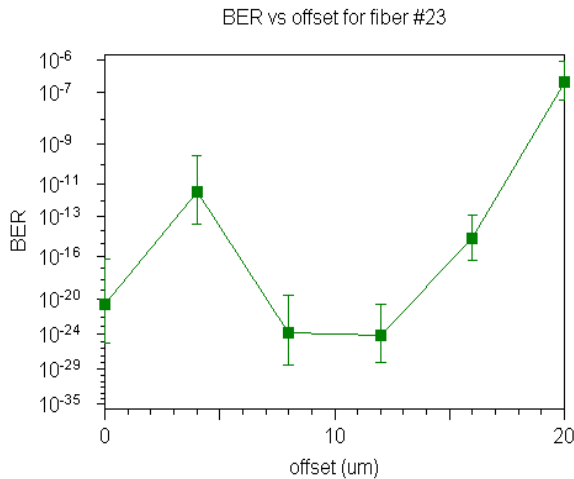
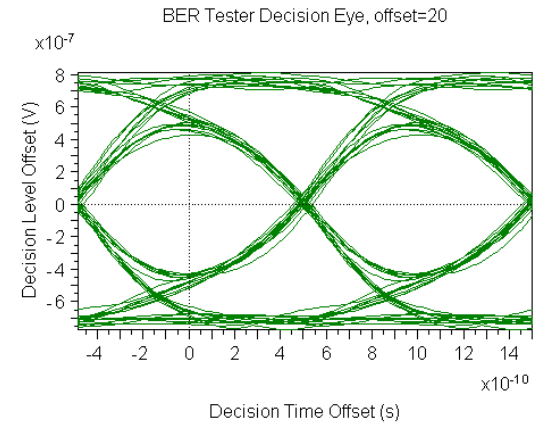
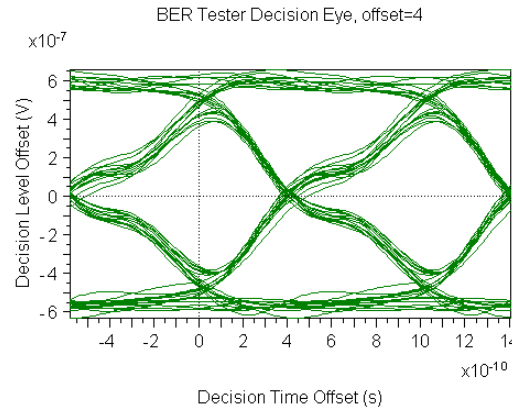
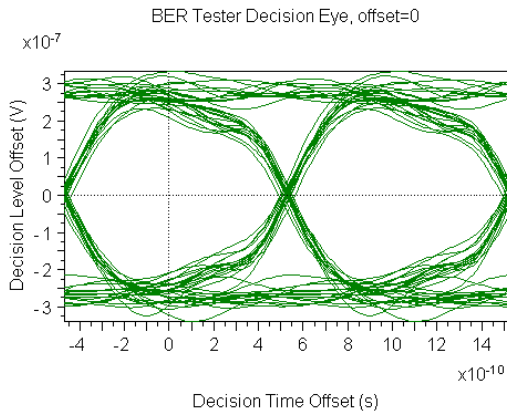

- Top 3 plots give eye diagram for fiber #23 at different radial offsets - 0, 4, and 20 microns.
- Plot on the left shows simulated BER vs. radial offset

Eye Diagrams and BER for fiber #81

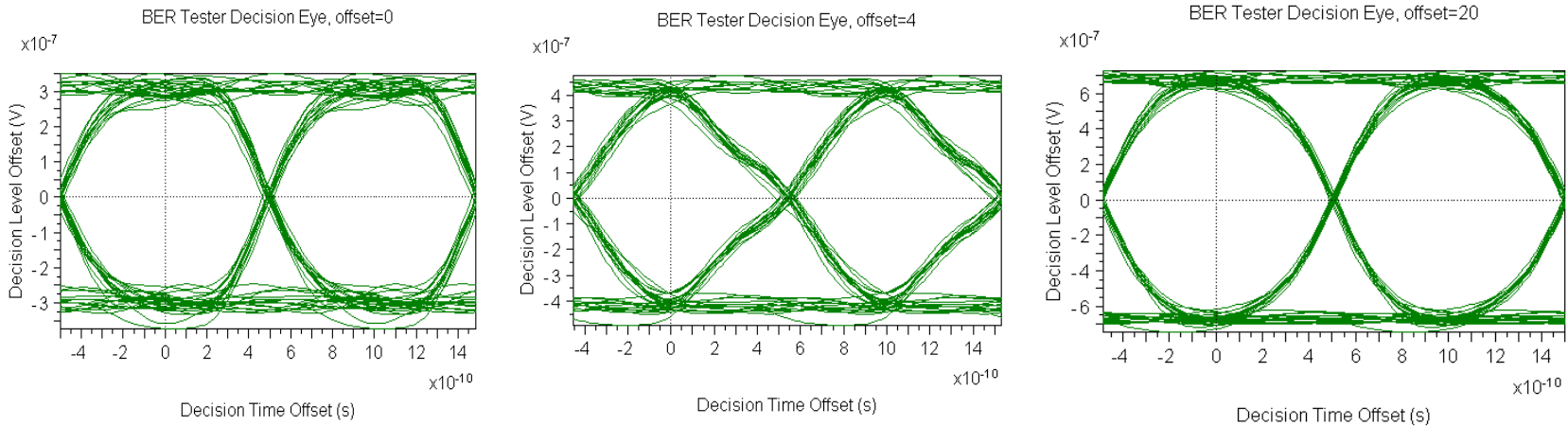

- Top 3 plots give eye diagram for fiber #81 at different radial offsets - 0, 4, and 20 microns.
- Plot on the right shows BER vs. radial offset

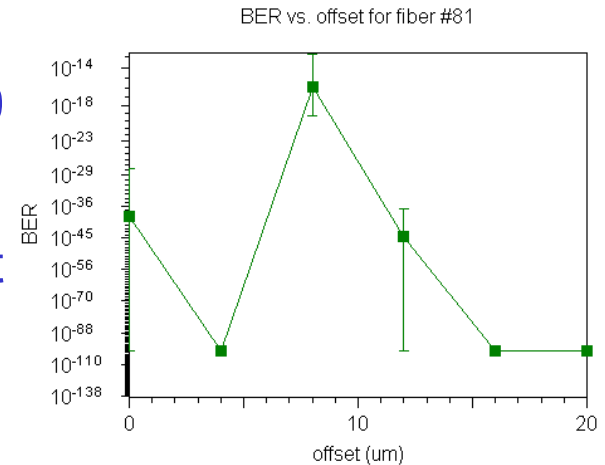

Summary

We demonstrated simulation results based on index profiles corresponding to the Cambridge model

- Simulations can take into account time-varying channel responses
- Further simulation studies can be performed by varying system and component parameters to study their impact on performance:
 - Chromatic dispersion
 - Fiber length
 - Radial/angular offset launch conditions, launched modal field, beam width, etc.
 - Launched temporal waveform / pulse shape
 - Variations/perturbations on fiber index profiles

Selected References

- B. K. Whitlock, E. Ghillino, J. Morikuni, P. Mena, R. Scarmozzino, "Mixed-Level and Mixed-Domain Modeling and Simulation for Optical Interconnect Design," *2004 Digest of the LEOS Summer Topical Meetings*, paper MB 1.4, June 28, 2004.
- J. Morikuni, E. Heller, P. Mena, B. K. Whitlock, and R. Scarmozzino, "A New Multimode Fiber Model for Optical Data Communication System Analysis," *2003 IEEE/LEOS Annual Meeting Conference Proceedings*, paper MO3, Tucson, Arizona, October 27, 2003.
- J. Morikuni, P. Mena, B. K. Whitlock, and R. Scarmozzino, "Multimode System Simulation as an Alternative to Spreadsheet Analysis for the Study of Gb/s Optical Communication Systems," *2003 IEEE/LEOS Annual Meeting Conference Proceedings*, paper MO4, Tucson, Arizona, October 27, 2003.
- J. Morikuni, P. Mena, B. K. Whitlock, and R. Scarmozzino, "Link-Level Design, Analysis, and Simulation of Multimode Data Communication Systems," *19th Annual National Fiber Optic Engineers Conference (NFOEC) Technical Proceedings*, pp. 858-867, Orlando, FL, Sep. 10, 2003.
- B. K. Whitlock, J. Morikuni, P. Mena, and R. Scarmozzino, "Recent Advances in Modeling and Simulation of Multimode Optical Links," *14th Annual IEEE Workshop on Interconnections Within High Speed Digital Systems*, Paper MB2, Santa Fe, NM, May 5, 2003.
- J. Morikuni, P. Mena, B. K. Whitlock, and R. Scarmozzino, "Simulation-Based Prediction of Multimode Fiber Bandwidth for 10 Gb/s Systems," *2002 IEEE/LEOS Annual Meeting Conference Proceedings*, paper WEE1, pp. 604-605, Glasgow, Scotland, November 13, 2002.
- J. Morikuni, P. Mena, B. K. Whitlock, and R. Scarmozzino, "Simulation of Modal Delays for 10 Gb/s Multimode Fiber Applications," *2002 IEEE/LEOS Annual Meeting Conference Proceedings*, paper ThDD4, pp. 903-904, Glasgow, Scotland, November 14, 2002.
- J. Morikuni, P. Mena, B. K. Whitlock, and R. Scarmozzino, "Measurement requirements for optical and optoelectronic model verification, validation, and calibration," *Technical Digest: Symposium on Optical Fiber Measurements, 2002*, NIST Special Publication 988, Boulder, Colorado, September 25, 2002.
- B. K. Whitlock, "Simulation Tools for Fiber Optic Link Design," *SAE Avionics System Division Meeting*, Tempe, Arizona, Oct. 15, 2002.
- J. Morikuni, B. Whitlock, P. Mena, and R. Scarmozzino, "Modeling and Simulation of Multimode Optical Fibers and Systems," *Telecommunication Industry Association (TIA) Plenary Meeting*, Kiawah Island, South Carolina, June 2002.