

Draft Standard for Layer 2 Transport Protocol for Time Sensitive Applications in Bridged Local Area Networks

Sponsor:

Microprocessor Standards Committee (MSC) of the IEEE Society

Prepared by the Audio/Video Bridging Layer2 Transport Working Group of the IEEE Computer Society Microprocessors and Microcomputers (C/MSC)

Abstract:

<<Editor's note: TBD>>

Keywords:

<<Editor's note: TBD>>

Copyright © 2007-2008 by the Institute of Electrical and Electronics Engineers, Inc.
Three Park Avenue
New York, New York 10016-5997, USA

All rights reserved. This document is an unapproved draft of a proposed IEEE Standard. As such, this document is subject to change. USE AT YOUR OWN RISK! Because this is an unapproved draft, this document must not be utilized for any conformance/compliance purposes. Permission is hereby granted for IEEE Standards Committee participants to reproduce this document for purposes of IEEE standardization activities only. Prior to submitting this document to another standards development organization for standardization activities, permission must first be obtained from the Manager, Standards Licensing and Contracts, IEEE Standards Activities Department. Other entities seeking permission to reproduce this document, in whole or in part, must obtain permission from the Manager, Standards Licensing and Contracts, IEEE Standards Activities Department.

IEEE Standards Activities Department
Standards Licensing and Contracts
445 Hoes Lane, P.O. Box 1331
Piscataway, NJ 08855-1331, USA

Introduction

(This introduction is not part of IEEE P1722/D0.03 Draft Standard for Layer 2 Transport Protocol for Time Sensitive Applications in Bridged Local Area Networks.)

<<Editor's note: Additional introductory text TBD>>

Editors' Foreword

<<Notes>>

<<Throughout this document, all notes such as this one, presented between angle braces, are temporary notes inserted by the Editors for a variety of purposes; these notes and the Editors' Foreword will all be removed prior to publication and are not part of the normative text.>>

<<Comments and participation in IEEE standards development>>

<<All comments on this draft are welcome and encouraged. This includes not only technical comments, but also in the areas of IEEE standards presentation style, formatting, spelling, etc. as a properly formatted and structured document will improve the understanding and implementability of all relevant technical details. It is also requested that all technical and editorial comments should not simply state what is wrong, but also what in the commenter's opinion should be done to fix the problem.

Full participation in the development of this draft requires individual attendance at IEEE P1722 meetings. Information on P1722 activities, working papers, and email distribution lists etc. can be currently be found on the AVBTP Website: <http://grouper.ieee.org/groups/1722/>

Use of the email distribution list is not presently restricted to IEEE MSC members, and the working group has had a policy of considering ballot comments from all who are interested and willing to contribute to the development of the draft. Individuals not attending meetings have helped to identify sources of misunderstanding and ambiguity in past projects. Non-members are advised that the email lists exist primarily to allow the members of the working group to develop standards, and are not a general forum.

Comments and questions on this document may be sent to the AVBTP email exploder, to the editor or to the chair (email addresses below). Information on joining the AVBTP email exploder can currently be found at:

<http://grouper.ieee.org/groups/1722/reflector.html>

PLEASE NOTE: Comments whose distribution is restricted in any way cannot be considered, and may not be acknowledged.

Editor of the P1722 Working Group:

Alan K. Bartky
SNAP networks
1871 SHARON LN
SANTA ANA CA 92705-5910
USA
+1 (714) 425 0967 (Tel)
EMAIL: alan@snap-networks.com

Chair of the P1722 Working Group:

Robert Boatright
Harman Pro
email: rboatright@ieee.org
+1 (801) 568-7566 office
+1 (801) 859-5294 mobile

>>

<<Editor's note: Document format and use of standard MSC templates for editing IEEE standards:

This document is being edited in Microsoft Word based on the 2007 standard MSC template and the goal of the working group is to adhere to the formats and conventions contained within the template and its associated guidelines document unless otherwise agreed to by the working group.

Standard MSC templates are available for Adobe Framemaker, Microsoft Word, and Open-Office. For more information and for additional web links to download the template files, please see:

<http://grouper.ieee.org/groups/msc/WordProcessors.html>

These templates are available under an open-source license; they may be used by any SDO, individual, or company. >>

Patents

Attention is called to the possibility that implementation of this standard may require use of subject matter covered by patent rights. By publication of this standard, no position is taken with respect to the existence or validity of any patent rights in connection therewith. The IEEE shall not be responsible for identifying patents or patent applications for which a license may be required to implement an IEEE standard or for conducting inquiries into the legal validity or scope of those patents that are brought to its attention.

For further information on IEEE patent policy, please see: <http://standards.ieee.org/board/pat/pat-slideset.pdf>

Participants

At the time this draft standard was completed, the Audio/Video Bridging Layer2 Transport Working Group had the following membership:

<< Editor's note: This list is based on active participants within recent history either by face to face meetings or by email contributions. At some point in the future, this will be replaced with an official list>>

Robert Boatright, Chair
Alan K. Bartky, Editor

Alan K. Bartky	John Nels Fuller	Suman Sharma
Alexei Beliaev	Chuck Harrison	Kevin Stanton
Robert Boatright	Raghu Kondapalli	Michael Johas Teener
George Claseman	Lee Minich	Fred Tuck
William Dai	Matt Mora	Niel Warren
Kevin Gross	Dave Olsen	Andy Yanowitz
Craig Gunther	Don Pannell	

The following members of the balloting committee voted on this standard. Balloters may have voted for approval, disapproval, or abstention.

1
2
3
4
5
6
7
8
9
10
11
12
13
14
15
16
17
18
19
20
21
22
23
24
25
26
27
28
29
30
31
32
33
34
35
36
37
38
39
40
41
42
43
44
45
46
47
48
49
50
51
52
53
54
55
56

(to be supplied by IEEE)

When the IEEE-SA Standards Board approved this standard on XX Month 200X, it had the following membership:

Name, Chair
name, Vice Chair
name, Secretary

(to be supplied by IEEE)

*Member Emeritus

Also included is the following nonvoting IEEE-SA Standards Board liaisons:

(To be supplied by IEEE)

Editor's name here
IEEE Standards Project Editor

Revision history

The following table shows the change history for this specification.

Version	Date	Author	Comments
0.01	2007-07-11	Alan K. Bartky	First version based on IEEE templates, IEEE other specifications and work to date from various contributions from http://www.avbtp.org
0.02	2007-07-13	Alan K. Bartky	Changed to MSC template. Misc. cleanup
0.03	2007-08-10	Alan K. Bartky	<p>Summary changes:</p> <ul style="list-style-type: none"> • Edited in initial proposals for Fragmentation/Reassembly, Cross-Timestamp functions. • Redesigned encapsulations to accommodate Fragmentation/Reassembly with standardized fields for fragment and packet lengths <ul style="list-style-type: none"> ○ Added additional quadlet to all stream data packets ○ Made it so all even numbered subtypes indicate “standard stream data header format, including 61883/IIDC and Proprietary/Experimental; and made odd numbered subtypes reserved for control <ul style="list-style-type: none"> ▪ With that, changed reserved subtype value for AV/C control data from 2 to 3. ▪ Also changed proprietary control messages to be subtype FF₁₆ with subtype_data of zero (0). • Edited in changes based on comments from Cupertino face to face meeting. • Copied line numbering format from latest MSC template. • Added hyperlink, table of contents, references, etc. to output PDF file.
0.04	2007-08-27	Alan K. Bartky	<ul style="list-style-type: none"> • Edited in changes based on discussions at Santa Clara face to face meeting, 2007-08-23. • Added 64 bit Stream ID for all frames. Updated diagrams and text accordingly. • Added Control/Data bit after Ethertype as MSB and changed subtype field from 7 to 8 bits. Updated values, text and tables accordingly. • Edited in some of the changes for fragmentation and reassembly based on emails and teleconference discussions. Still more work to go here, but should be good enough to start discussing again. • Created new Annex Z for holding of issues and resolutions during creation of this specification. • Started editing some text from initial cut and paste bullets from my PowerPoint based contributions to be more “standard like” text. Still a lot more to go on this, but again hopefully still good enough to discuss at our meetings.

0.05	2007-11-29	Alan K. Bartky	<ul style="list-style-type: none"> • David V. James edited in suggested style, syntax, etc. type changes. Editor reviewed all of them and chose which to accept into the document (comments/question on those not accepted welcome). • Edited multiple encapsulation changes to realign the AVBTP frame to have the same quadlet alignment as IP packets (original alignment was based on trying to align the AVBTP packet in the same quadlet alignment as an Ethernet Frame, IP packets are actually not quadlet aligned with the frame as the Ethernet header is either 14 or 18 bytes long depending on if the frame is untagged (14) or tagged (18) format. Basically added two additional bytes at the start of each frame. • Changed control frame encapsulation to have a standard length and status field (i.e. took advantage of the 2 new bytes added). • Incorporated initial cut and paste and some modifications to John Nels Fuller’s contribution on AV/C Command Transport Protocol. • Misc. cleanup, rewording and clarification of Fragmentation section (still more to work here). • Initial incorporation of Craig Gunther’s contribution on AVBTP timestamp and 61883 SYT processing (mostly cut and paste, some minor edit’s)
0.06	2008-03-07	Alan K. Bartky	<ul style="list-style-type: none"> • Edited in John’s Fuller’s contribution on Command Transport Protocol and did some misc. editing and cleanup. Also, per group consensus changed OPEN and CLOSE to OPEN and CLOSE • Edited in Dave Olsen’s contributions on Timing/Synchronization and also MAC address allocation. For MAC address Allocation, created a new normative Annex (note: this may move to another IEEE 802 based standard in the future, but for now, we will keep working on this in P1722). <ul style="list-style-type: none"> ○ In process of editing the text in, did several changes from “should” to “shall” based on my understanding of the text and needs of the protocol as described by the text. The editor kindly requests others review all uses of “should” and “shall” throughout the document. • Updated AVBTP name list to be more reflective of those actually working and contributing to the standard. • Moved fragmentation/reassembly details from main text to Annex B as native AVBTP end stations will use CIP to do the breaking up of source data into AVBTP packets and will not support CIP packets that do not fit in a maximum size Ethernet frame. This work may still be useful for IEEE 1394 to AVBTP interworking units, so moving the text and diagrams there as a placeholder. • Added some placeholder text from some new assumptions as discussed at the Sandy Utah face to face meeting and entered into the draft assumptions document.

1
2
3
4
5
6
7
8
9
10
11
12
13
14
15
16
17
18
19
20
21
22
23
24
25
26
27
28
29
30
31
32
33
34
35
36
37
38
39
40
41
42
43
44
45
46
47
48
49
50
51
52
53
54
55
56

0.7	2008-04-07	Alan K. Bartky	<ul style="list-style-type: none"> • Updated editor’s contact information • Updated Web page and email address info to official IEEE 1722 web site • Significantly updated Annex C based on discussions in IEEE 1722 and 802.1 AVB meetings. <ul style="list-style-type: none"> ○ Changed from “Multicast MAC address acquisition protocol” to “MAC address acquisition protocol” to reflect request to allow protocol to be expanded to also allow allocation of Source MAC addresses and to allow for a future DHCP like server for allocating MAC addresses. <ul style="list-style-type: none"> ▪ Based on that added new proposed fields and protocol operations ○ Added new tables and parameters to make it easier to tune. • Per discussions from last face to face meeting and also on teleconferences, Changed fields: <ul style="list-style-type: none"> ○ gm_info to gm_discontinuity ○ gm_generation to stream_reserved2
0.8	2008-05-18	Alan K. Bartky	<ul style="list-style-type: none"> • Removed Cross timestamp and Fragmentation from Annex B based on agreement to have 1394 to Ethernet AVBTP gateways use the source cycle time in the gateway_info field and require that 1394 to AVBTP gateways break up and reassemble as necessary on data block boundaries (i.e. Break up large CIP packets into multiple smaller CIP packets that fit on Ethernet and then reassemble as necessary when sending back on 1394 networks). • Changed diagrams and data definition to look more like IETF documents (bits 00-31, big endian format). Came up with a hybrid format that hopefully should please those familiar with 1394 conventions and/or IETF conventions. • Changed format and some supporting text on MAAP protocol in Annex C to: <ul style="list-style-type: none"> ○ Use start and length instead of start and end ○ Added renewal time field • Started some work on 61883 based timing and synchronization sections by going through the 61883 series of documents and putting in this document key sections that need to change to work in an AVBTP environment based on design needs and discussions to date.

1
2
3
4
5
6
7
8
9
10
11
12
13
14
15
16
17
18
19
20
21
22
23
24
25
26
27
28
29
30
31
32
33
34
35
36
37
38
39
40
41
42
43
44
45
46
47
48
49
50
51
52
53
54
55
56

1
2
3
4
5
6
7
8
9
10
11
12
13
14
15
16
17
18
19
20
21
22
23
24
25
26
27
28
29
30
31
32
33
34
35
36
37
38
39
40
41
42
43
44
45
46
47
48
49
50
51
52
53
54
55
56

<p>0.9</p>	<p>2008-06-15</p>	<p>Alan K. Bartky</p>	<ul style="list-style-type: none"> • Edited text based on editorial comments received from Kevin Gross • Misc. editing of some TBD and placeholder text into more descriptive text. • Removed John Fuller’s Command Transport Protocol (CTP) as we now have consensus that for 61883 over AVBTP applications that require AV/C, we will instead require the use of the new AV/C over IP specification being developed by the 1394 Trade Association. • Added gateway info valid field based on recommendation from Matt Mora and agreed to at AVBTP teleconferences. Created initial draft text to describe the field and also updated all stream data packet diagrams accordingly. • Misc. cleanup/clarification of bits within bytes for various fields in AVBTP frames. • Added additional reference documents and referenced them within the document as appropriate. • Added additional details (diagrams and text) for handling of CIP packets with source packets (SPH==1) of 61883-4 and -7 (MPEG over CIP).
----------------------------	-----------------------------------	---------------------------------------	---

Table of contents

	1
	2
	3
1. Overview	4
1.1 Scope	5
1.2 Purpose	6
1.3 Clauses	7
	8
	9
2. References	10
	11
3. Terms, definitions, and notation	12
3.1 Conformance levels	13
3.2 Glossary of terms	14
3.3 Unimplemented locations	15
3.4 Numerical values	16
3.5 Notation of fields and values taken from other documents	17
3.5.1 Field value conventions	18
3.6 Informative notes	19
	20
4. Abbreviations and acronyms	21
	22
5. AVBTP base protocol	23
5.1 Overview	24
5.1.1 General assumptions/operations	25
5.2 802.3 Media specific encapsulation	26
5.2.1 802.3 Destination MAC address field	27
5.2.2 802.3 Source MAC address field	28
5.2.3 802.1Q header field	29
5.2.4 AVBTP Ethertype, 16 bits:	30
5.3 802.11 Media specific encapsulation	31
5.4 AVBTP frame common header format	32
5.4.1 cd (control/data indicator) field	33
5.4.2 subtype field	34
5.4.3 sv field	35
5.4.4 subtype_data1 field	36
5.4.5 subtype_data2 field	37
5.4.6 stream_id field	38
5.5 AVBTP common control frame header format	39
5.5.1 control_data1 field	40
5.5.2 status field	41
5.5.3 control_data_length field	42
5.6 AVBTP common stream data frame header format	43
5.6.1 subtype_data1 field subfields	44
5.6.2 gv: (gateway_info field valid) subfield	45
5.6.3 tv: (avbtp_timestamp field valid) subfield	46
5.6.4 gm_discontinuity field	47
5.6.5 h (holdover) field	48
5.6.6 stream_id (802.1Qat stream identifier) field	49
5.6.7 avbtp_timestamp field	50
5.6.8 gateway_info field	51
5.6.9 packet_data_length field	52
5.6.10 protocol_specific_packet_header field	53
5.6.11 stream_data_payload field	54
5.7 Timing and synchronization	55
5.7.1 General	56

1	5.7.2 AVBTP presentation time.....	42
2	5.7.3 gm_discontinuity	42
3	5.8 Protocol layering and other required protocols	44
4	5.9 Service interface.....	44
5		
6	6. 61883/IIDC over AVBTP protocol.....	45
7	6.1 Overview.....	45
8	6.2 Common 61883/IIDC Stream data encapsulation.....	46
9	6.2.1 tag field.....	47
10	6.2.2 channel field.....	47
11	6.2.3 tcode (type code).....	47
12	6.2.4 sy field	47
13	6.3 "Data field unformatted" encapsulation (used by IIDC).....	48
14	6.4 IEC-61883 CIP encapsulation.....	49
15	6.4.1 CIP header 1st quadlet indicator	50
16	6.4.2 SID (source ID) field	50
17	6.4.3 Data Block Size (DBS).....	51
18	6.4.4 QPC (quadlet Padding count)	51
19	6.4.5 FN (fraction number) field.....	51
20	6.4.6 SPH (source packet header) field.....	51
21	6.4.7 <u>Rsv</u> (reserved) field.....	51
22	6.4.8 DBC (data block count) field	51
23	6.4.9 CIP header 2nd quadlet indicator.....	51
24	6.4.10 FMT (stream format), field	51
25	6.4.11 FDF (format dependent field)	52
26	6.4.12 SYT (synchronization timing) field (1394 cycle time based presentation time for SPH field equals 0)	52
27	6.4.13 avbtp_source_packet_header_timestamp field (802.1AS time based presentation time for SPH field	
28	equals 1).....	52
29	6.5 61883 over AVBTP control frame format	53
30	6.6 Use of AV/C higher layer protocol in 61883 over AVBTP end stations	53
31	6.7 Protocol layering.....	54
32	6.8 Session management.....	55
33	6.8.1 Overview.....	55
34	6.8.2 General Protocol operation	55
35	6.9 Timing and Synchronization.....	56
36	6.9.1 General.....	56
37	6.9.2 61883-2 timing and synchronization	56
38	6.9.3 61883-4 timing and synchronization	57
39	6.9.4 61883-6 timing and synchronization	57
40	6.9.5 61883-7 timing and synchronization	58
41	6.9.6 61883-8 timing and synchronization	59
42	6.10 Service Interface	60
43		
44	7. Proprietary/Experimental subtype AVBTP protocol.....	61
45	7.1 Overview.....	61
46	7.2 Proprietary/Experimental subtype stream data format	61
47		
48	Annex A (informative) Bibliography.....	63
49		
50	Annex B (normative) Interworking 61883 between AVBTP and IEEE 1394 networks.....	65
51	B.1 Introduction	65
52	B.2 1394 to/from IEEE 802 AVBTP Interworking scenarios	65
53	B.3 IWU session management	65
54	B.3.1 General	65
55	B.3.2 Stream join	66
56	B.3.3 Data transfer	66

B.3.4 Stream leave	66	1
B.3.5 IWU data adaptation.....	66	2
B.3.6 General	66	3
B.3.7 Encapsulation	66	4
B.3.8 Stream Sequencing, Fragmentation and Reassembly procedures.....	68	5
B.4 Timing and synchronization	68	6
B.4.1 General	68	7
B.4.2 Timing adaptations/control.....	69	8
B.4.3 Synchronization.....	70	9
B.4.4 Queuing/Scheduling Mechanisms	70	10
		11
Annex C (normative) MAC Address Acquisition Protocol (MAAP).....	72	12
C.1 Overview	72	13
C.2 Protocol Message Format	73	14
C.3 Requesting an address range.....	76	15
C.4 Announcing an acquired MAC Address Range.....	77	16
C.5 Defending a MAC Address Range	77	17
		18
Annex Z (informative) COMMENTARY	79	19
Z.1 Unicast Destination MAC address support for stream data frames?.....	79	20
Z.2 Need mechanism for getting PCP value for Class A and Class B streams	79	21
Z.3 Does AV/C protocol need its own subtype?	79	22
Z.4 Need to define more details on format and function of AVBTP source Timestamp and relationship to use of the 61883 SYT field.....	80	23
Z.5 Need to define how 802.1Qat stream IDs are used by AVBTP	81	24
Z.6 Need to define what happens if presentation time has passed and/or is out of range.....	81	25
		26
		27
		28
		29
		30
		31
		32
		33
		34
		35
		36
		37
		38
		39
		40
		41
		42
		43
		44
		45
		46
		47
		48
		49
		50
		51
		52
		53
		54
		55
		56

1 **List of figures**
 2
 3 Figure 3.1 - Bit ordering within a byte 21
 4 Figure 3.2 - Byte ordering within a quadlet 22
 5 Figure 3.3 - Example 4 byte quadlet field diagram 22
 6 Figure 3.4 - Example 8 byte octlet field diagram 22
 7 Figure 5.1 - AVBTP frame within an 802.3 frame with 802.11Q tag field 28
 8 Figure 5.2 - AVBTP frame within an 802.3 frame without an 802.11Q Tag field 29
 9 Figure 5.3 —AVBTP frame common header fields 32
 10 Figure 5.4 - Control frame common fields 36
 11 Figure 5.5 --AVBTP common stream data header format (cd field set to zero) 39
 12 Figure 6.1 61883/IIDC common header fields 46
 13 Figure 6.2 - 61883/IIDC frame header fields 48
 14 Figure 6.3—CIP header and data fields, tag= 1, SPH = 0 49
 15 Figure 6.4—CIP header and data fields, tag=1, SPH = 1 50
 16 Figure 7.1 -- Proprietary/Experimental stream data format 61
 17 Figure 7.2—Proprietary/Experimental control escape subtype format 62

18 **List of tables**
 19
 20 Table 3.1 wrap field values 23
 21 Table 5.1 -- AVBTP *subtype* values 34
 22
 23
 24
 25
 26
 27
 28
 29
 30
 31
 32
 33
 34
 35
 36
 37
 38
 39
 40
 41
 42
 43
 44
 45
 46
 47
 48
 49
 50
 51
 52
 53
 54
 55
 56

Draft Standard for Layer 2 Transport Protocol for Time Sensitive Applications in Bridged Local Area Networks

1. Overview

Increasingly, entertainment media is digitally transported. Streaming audio/video and interactive applications over bridged LANs need to have comparable real-time performance with legacy analog distribution. There is significant end-user and vendor interest in defining a simple yet common method for handling real-time audio/video suitable for consumer electronics, professional A/V applications, etc. Technologies such as IEEE 1394, Bluetooth and USB exist today but each has their own encapsulation, protocols, timing control, etc. such that building interworking functions is difficult. The use of a common audio/video transport over multiple IEEE 802 network types will realize operational and equipment cost benefits. By ensuring that all IEEE 802 wired and wireless devices share a common set of transport mechanisms for time-sensitive audio/video streams, we lessen the effort of producing interworking units between IEEE 802 and other digital networks.

<<Editor's note: The above text was copied from the IEEE P1722 PAR. This will be expanded or edited as appropriate.>>

1.1 Scope

This standard specifies the protocol, data encapsulations, connection management and presentation time procedures used to ensure interoperability between audio and video based end stations that use standard networking services provided by all IEEE 802 networks meeting QoS requirements for time-sensitive applications by leveraging concepts of IEC 61883-1 through IEC 61883-7.

<<Editor's note: The above text was copied from the IEEE P1722 PAR. This will be expanded or edited as appropriate.>>

1.2 Purpose

This standard will facilitate interoperability between stations that stream time-sensitive audio and/or video across LANs providing time synchronization and latency/bandwidth services by defining the packet format and stream setup, control, and teardown protocols.

<<Editor's note: The above text was copied from the IEEE P1722 PAR. This will be expanded or edited as appropriate.>>

1.3 Clauses

Clauses in this document are as follows:

1 Clause 1. Overview.
2
3 Clause 2. [References](#)
4 Clause 3. [Terms, definitions, and notation](#)
5 Clause 4. [Abbreviations and acronyms](#)
6
7 Clause 5. [AVBTP base protocol](#)
8
9 Clause 6. [61883/IIDC over AVBTP protocol](#)
10 Clause 7. [Proprietary/Experimental subtype AVBTP protocol](#)
11
12 Annex A. (informative) Bibliography.
13 Annex B (normative) Interworking 61883 between AVBTP and IEEE 1394 networks
14
15 Annex C (normative) MAC address Acquisition protocol
16
17 Annex Z ([informative](#)) [COMMENTARY](#)
18
19
20
21
22
23
24
25
26
27
28
29
30
31
32
33
34
35
36
37
38
39
40
41
42
43
44
45
46
47
48
49
50
51
52
53
54
55
56

2. References

The following standards contain provisions that, through reference in this document, constitute provisions of this standard. All the standards listed are normative references. Informative references are given in Annex A. At the time of publication, the editions indicated were valid. All standards are subject to revision, and parties to agreements based on this standard are encouraged to investigate the possibility of applying the most recent editions of the standards indicated below.

- [R1] IEEE Std 802®, IEEE Standard for Local and Metropolitan Area Networks: Overview and Architecture ¹
- [R2] IEC 61784-2:2007, Digital data communications for measurement and control – Part 2: Additional profiles for ISO/IEC 8802-3 based communication networks in real-time applications²
- [R3] IEEE 802.3-2005, IEEE Standards for Information technology – Telecommunications and information exchange between systems – Local and metropolitan area networks – Specific requirements – Part 3: Carrier sense multiple access with collision detection (CSMA/CD) access method and Physical Layer specifications
- [R4] IEEE Std 802.1Q-2005, IEEE Standard for Local and Metropolitan Area Networks---Virtual Bridged Local Area Networks;
- [R5] IEEE P802.1AS, IEEE standard for Local and Metropolitan Area Networks: Timing and Synchronization for Time-Sensitive Applications in Bridged Local Area Networks;
<< draft document, see: <http://www.ieee802.org/1/pages/802.1as.html>>>
- [R6] IEEE P802.1Qat, IEEE standard for Local and Metropolitan Area Networks: Virtual Bridged Local Area Networks - Amendment 9: Stream Reservation Protocol;
<<draft document, see: <http://www.ieee802.org/1/pages/802.1at.html>>>
- [R7] IEEE P802.1Qav, IEEE standard for Local and Metropolitan Area Networks: Virtual Bridged Local Area Networks - Amendment 11: Forwarding and Queuing for Time-Sensitive Streams;
<<draft document, see: <http://www.ieee802.org/1/pages/802.1av.html>>>
- [R8] [IEEE 802.1ak, Virtual Bridged Local Area Networks, - Amendment 07: Multiple Registration Protocol](#)
- [R9] [IEEE P802.1ak-2007/Cor 1 Draft Standard for Local and Metropolitan Area Networks - Virtual Bridged Local Area Networks - Amendment 07: Multiple Registration Protocol- Corrigendum 1](#)
- [R10] [IEEE P802.1AB-REV Draft Standard for Local and Metropolitan Area Networks - Station and Media Access Control Connectivity Discovery](#)
<<draft document, see: <http://www.ieee802.org/1/pages/802.1AB-rev.html>>>
- [R11] IEC 61883-1 (2003-01) Consumer audio/video equipment - Digital interface - Part 1: General;

¹ IEEE publications are available from the Institute of Electrical and Electronics Engineers, 445 Hoes Lane, P.O. Box 1331, Piscataway, NJ 08855-1331, USA. New and revised IEEE standards and drafts are available for sale individually (<http://shop.ieee.org/>), and are also available, via an online subscription (<http://standards.ieee.org/catalog/olis/index.html>). The Get IEEE 802™ program (<http://standards.ieee.org/getieee802/portfolio.html>) grants public access to view and download current individual electronic (PDF) IEEE Local and Metropolitan Area Network (IEEE 802®) standards at no charge twelve months after publication.

² IEC publications are available from IEC Sales Department, Case Postale 131, 3, rue de Varembe, CH-1211, benève 20, Switzerland/Suisse. IEC publications are also available in the United States from the Sales Department, American National Standards Institute, 11 West 42nd Street, 13th Floor, New York, NY 10036, USA . IEC publications are available for sale individually, and are also available via an online subscription (<http://webstore.iec.ch/>).

- 1 [R12] IEC 61883-2 (2004-08) Consumer audio/video equipment - Digital interface - Part 2: SD-DVCR data
2 transmission;
- 3
- 4 [R13] IEC 61883-4 (2004-08) Consumer audio/video equipment - Digital interface - Part 4: MPEG2-TS data
5 transmission;
- 6
- 7 [R14] IEC 61883-6 (2005-10) Consumer audio/video equipment - Digital interface - Part 6: Audio and music data
8 transmission protocol;
- 9
- 10 [R15] IEC 61883-7 (2003-01) Consumer audio/video equipment – Digital interface - Part 7: Transmission of ITU-R
11 BO.1294 System B
- 12
- 13 [R16] IEC 61883-8 (work in progress) Consumer audio/video equipment - Digital interface - Part 8: Transmission of
14 ITU-R Bt.601 style Digital Video Data
- 15
- 16 [R17] 1394 Trade Association TA Document 2003017 IIDC 1394-based Digital Camera Specification Ver.1.31³
- 17
- 18 [R18] [1394 Trade Association TA Document 2004006 AV/C Digital Interface Command Set General Specification](#)
19 [Version 4.2](#)
- 20
- 21 [R19] [1394 Trade Association TA Document 2006021 Networking IEEE 1394 Clusters via UWB over Coaxial Cable](#)
22 [- Part 3: FCP and CMP over IPv4](#)
23 [<<Editor’s note: Work in progress, current draft is version 1.0, May 28, 2008>>](#)
- 24
- 25 [R20] IETF RFC 791 Internet Protocol (<http://www.ietf.org/rfc/rfc0791.txt?number=0791>)
- 26
- 27 [R21] [IETF RFC 768 User Datagram Protocol \(http://www.ietf.org/rfc/rfc0768.txt?number=0768\)](#)
- 28

29 All the standards listed are normative references. Informative references are given in Annex A. At the time of publication,
30 the editions indicated were valid.

31

32 << Editor’s note: Per MSC standards guidelines, need footnotes above on “how this document can be obtained
33 and/or purchased”, some of this work is TBD (will need info on how to obtain, IEC, 1394TA and possibly other
34 documents). Also hopefully the boilerplate text from the template (2005) is still correct/OK>>

35 <<Editor’s note: For some reason, my PDF converter tool is not creating hyperlinks in the PDF file if the
36 hyperlink is in a footnote. For now, here are the links in an editor’s note to make it easier for the reader to get to
37 those web pages:>>

38

39

40

41 New and revised IEEE standards and drafts are available for sale individually (<http://shop.ieee.org/>), and are also
42 available, via an online subscription (<http://standards.ieee.org/catalog/olis/index.html>). The Get IEEE 802™® program
43 (<http://standards.ieee.org/getieee802/portfolio.html>) grants public access to view and download current individual
44 electronic (PDF) IEEE Local and Metropolitan Area Network (IEEE 802®) standards at no charge twelve months after
45 publication.

46

47 IEC publications are available for sale individually, and are also available via an online subscription
48 (<http://webstore.iec.ch/>).

49

50

51

52 ³ 1394 Trade Association (1394TA) Members can download the 1394TA specifications for free from the members' website. Please
53 note, however, that the copy right for each specification belongs to the 1394TA. Membership information can be found at:
54 <http://www.1394ta.org/About/Join/>. For non-members, please contact jsnider@1394ta.org for information on how to obtain a copy of
55 the 1394TA specifications and Technical Bulletins . The mailing address for the association is at: 1394 Trade Association Office
56 1560 East Southlake Blvd., Suite 242, Southlake TX 76092 USA

1394 Trade Association (1394TA) Members can download the 1394TA specifications for free from the members' website. Please note, however, that the copy right for each specification belongs to the 1394TA. Membership information can be found at: <http://www.1394ta.org/About/Join/>. For non-members, please contact jsnider@1394ta.org for information on how to obtain a copy of the 1394TA specifications and Technical Bulletins.

Internet Requests for Comments (RFCs) are available on the World Wide Web at the following URL: <http://www.ietf.org/rfc.html>.

3. Terms, definitions, and notation

3.1 Conformance levels

Several keywords are used to differentiate between different levels of requirements and optionality, as follows:

1
2
3
4
5
6
7
8
9
10
11
12
13
14
15
16
17
18
19
20
21
22
23
24
25
26
27
28
29
30
31
32
33
34
35
36
37
38
39
40
41
42
43
44
45
46
47
48
49
50
51
52
53
54
55
56

1 **3.1.1 expected:** Describe the behavior of the hardware or software in the design models assumed by this specification.
2 Other hardware and software design models may also be implemented.
3

4 **3.1.2 may:** Indicates a course of action permissible within the limits of the standard with no implied preference (“may”
5 means “is permitted to”).
6

7 **3.1.3 shall:** Indicates mandatory requirements strictly to be followed in order to conform to the standard and from which
8 no deviation is permitted (“shall” means “is required to”).
9

10 **3.1.4 should:** An indication that among several possibilities, one is recommended as particularly suitable, without
11 mentioning or excluding others; or that a certain course of action is preferred but not necessarily required; or that (in the
12 negative form) a certain course of action is deprecated but not prohibited (“should” means “is recommended to”).
13

14 **3.2 Glossary of terms**

15
16
17 **3.2.1 1 AVBTP communication:** Information used in the operation of the AVBTP protocol, transmitted in an AVBTP
18 message over an AVBTP communication path.
19

20 **3.2.2 Audio/Video Bridging Transport Protocol. (AVBTP):** The protocol defined by this standard. As an adjective, it
21 indicates that the modified noun is specified in or interpreted in the context of this standard.
22

23 **3.2.3 AVBTP communication path:** A segment of a network enabling direct communication between two or more
24 AVBTP end stations.
25

26 **3.2.4 AVBTP stream:** An AVBTP stream is between one talker and one or more listeners
27

28 **3.2.5 AVBTP port:** A logical access point of an AVBTP clock for AVBTP communications to the communications
29 network.
30

31 **3.2.6 big endian:** A method of transmitting a multi-byte integer. Bytes are transmitted in order of decreasing
32 significance, i.e. the most significant byte is transmitted first.
33

34 **3.2.7 byte:** Eight bits of data, used as a synonym for octet.
35

36 **3.2.8 controller:** A device that introduces and manages talkers and listeners, and manages groups of sessions.
37

38 **3.2.9 class A:** P802.1Qav stream data traffic class with 125 μ s observation interval
39

40 **3.2.10 class B:** P802.1Qav stream data traffic class with TBD millisecond observation interval.
41

42 **3.2.11 default:** In this document the word default when applied to attribute values and options means the configuration of
43 an AVBTP device as it is delivered from the manufacturer.
44

45 **3.2.12 doublet:** Two bytes of data.
46

47 **3.2.13 epoch:** The origin of a timescale.
48

49 **3.2.14 event:** An abstraction of the mechanism by which signals or conditions are generated and represented.
50

51 **3.2.15 grandmaster selection time:** The maximum amount of time required by 802.1AS to elect and propagate new
52 grand master address.
53

54 **3.2.16 holdover:** A clock previously synchronized/syntionized to another clock (normally a primary reference or a master
55 clock) but now free-running based on its own internal oscillator, whose frequency is being adjusted using data acquired
56

while it had been synchronized/syntonized to the other clock, is said to be in holdover or in the holdover mode, as long as it is within its accuracy requirements.

3.2.17 holdover mode: When the 802.1AS clock is [currently known to be or](#) possibly [unstable](#) due to a [loss or](#) change in the grandmaster [clock status](#). [When detected and reported, the](#) listener and talker shall revert to [an internal holdover](#) timing mode, ignoring the 802.1AS clock until the 802.1AS clock has once again stabilized.

3.2.18 ingress time: Ingress time is when the sample is sent by the talker application to the AVBTP layer. For example, on an I2S interface this is an 802.1AS timestamp of the word clock transition for the received sample.

3.2.19 link: A network segment between two IEEE 802 ports.

3.2.20 listener: A listener is a receiver of a stream.

3.2.21 maximum holdover time: The maximum time allowed for Grandmaster Selection plus clock stabilization on a listener.

3.2.22 multicast communication: A single AVBTP message sent from any AVBTP port and received and processed by all AVBTP ports on the same AVBTP communication path.

3.2.23 node: A device that can issue or receive AVBTP communications on a network.

3.2.24 octet: Eight bits of data, used as a synonym for byte.

3.2.25 octlet: Eight bytes of data.

3.2.26 port number: An index identifying a specific AVBTP port.

3.2.27 presentation time: Presentation time is the ingress time plus a delay constant

3.2.28 quadlet: Four bytes of data.

3.2.29 synchronized clocks: Two clocks are synchronized to a specified uncertainty if they have the same epoch and their measurements of the time of a single event at an arbitrary time differ by no more than that uncertainty. The timestamps generated by two synchronized clocks for the same event differ by no more than the specified uncertainty.

3.2.30 syntonized clocks: Two clocks are syntonized if they share the same definition of a second, which is the time as measured by each advances at the same rate. They may or may not share the same epoch.

3.2.31 talker: A talker is the source of a stream

3.2.32 timeout: A mechanism for terminating requested activity that, at least from the requester's perspective, does not complete within the time specified.

3.2.33 timescale: A linear measure of time from an epoch.

3.3 Unimplemented locations

The capabilities of all reserved, ignored, and unused values are carefully defined, to minimize conflicts between current implementations and future definitions.

3.3.1 reserved fields: A set of bits within a data structure that is defined in this specification as reserved, and is not otherwise used. Implementations of this specification shall zero these fields. Future revisions of this specification, however, may define their usage.

3.3.2 ignored location: Selected locations or portions of locations are partially implemented and are defined to be ignored. An ignored value has an affiliated storage element, but the value in the storage elements has no side effect.

3.3.3 reserved location: Some locations or portions of locations are not implemented and are defined to be reserved. When a reserved value is written, a zero values shall be assumed; when read, the returned value shall be ignored.

3.3.4 unused location: Selected locations or portions of locations may be not implemented or partially implemented and are defined to be unused. For unused locations, the selection between reserved and ignored behaviors is implementation dependent.

3.4 Numerical values

Decimal, hexadecimal, and binary numbers are used within this document. For clarity, decimal numbers are generally used to represent counts, hexadecimal numbers are used to represent addresses, and binary numbers are used to describe bit patterns within binary fields.

Decimal numbers are represented in their usual 0, 1, 2, ... format. Hexadecimal numbers are represented by a string of one or more hexadecimal (0-9,A-F) digits followed by the subscript 16. Binary numbers are represented by a string of one or more binary (0,1) digits in left to right order where the left most bit is the most significant bit and the right most bit is the least significant bit, followed by the subscript 2. Thus the decimal number "26" may also be represented as "1A₁₆" or "11010₂".

These notational conventions have one exception: MAC addresses and OUI/EUI values are represented as strings of 8-bit hexadecimal numbers separated by hyphens and without a subscript, as for example "01-80-C2-00-00-15" or "AA-55-11".

3.5 Notation of fields and values taken from other documents

<<Editor's note: For version 0.08, I have again reworked the notation section, this time to more follow conventions used in IETF RFCs as this document defines a transport layer and should not care about bit transmission order. So this document uses a merged convention to allow implementers who understand IETF RFCs and/or IEEE 1394 and/or 1394 Trade Association (1394TA) document conventions. This hopefully also should make it easier for implementers who wish to port their 1394/61883 technology to 802.1/802.3 Ethernet and 802.11 wireless networks or for implementers who have IP based technology to port/modify (i.e. if they can get the bit ordering correct for an IP packet, they can get it right for based on diagrams from this document). All comments on this change are welcome by the editor

It is also the editor's intent to take out unused template for areas not currently used by this draft (such as state machine conventions, descriptions on how to document registers, etc. If it turns out that we need to add any of these types of items in future versions of the spec, then these portions of the template can be put back into the document.>>

This document uses fields and values defined in other documents with multiple methods of defining such things as usage of upper and lower case, usage of underscore characters, italics, etc. As this document is intended to use these multiple protocols, its additional intent is also to make it easier for readers and implementers of those documents by not using different names and notation for those fields and values. So the following conventions are used for field names from other documents to match the convention from those documents.

- a) Fields from IEEE 802.1Q: Fields are in all uppercase, no underscores (examples: DA, SA, TPID, CFI, VID)
- b) Fields from IEEE 1394: Fields in lower case except for acronyms within the field name with optional underscores (examples: tcode, data_length, source_ID)
- c) Fields from IEC 61883: Fields always starting in uppercase, acronyms in uppercase, abbreviations with uppercase first followed by lowercase, no underscores (examples: DBC, DBS, Rsv).

3.2.2 Bit, byte, doublet, quadlet and octlet ordering

Similar to IETF RFC 0791 [R17] Internet Protocol (IP), this protocol is agnostic to the underlying bit order used by layers below it. Therefore all frame and packet formats contained within are specified as a series of 8 bit bytes where the actual transmission, reception, storage and retrieval of bits within the bytes are machine and/or lower layer specific.

This document uses the same convention as IEEE 1394 for abbreviating the following terms:

- a) lsb: least significant bit ([bit 7](#))
- b) msb: most significant bit ([bit 0](#))
- c) LSB: least significant byte
- d) MSB: most significant byte

Like Internet Protocol, the actual ordering of multiple bytes to store larger numbers or arrays of data is specified in big-endian order where the first byte of a multi-byte number is the most significant byte and the last byte is the least significant byte.

The significance of the interior bits within a byte uniformly decreases in progression from msb to lsb where msb is labeled as bit 0 and lsb is bit 7 and is shown in this document in a left to right order as follows.

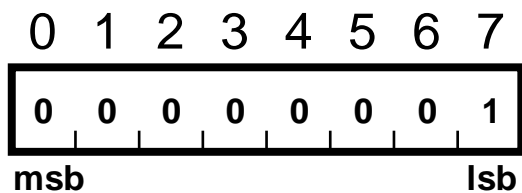

Figure 3.1 - Bit ordering within a byte

For the above figure, this would represent a decimal value of 1, a hexadecimal value of 01_{16} and a binary value of 00000001_2 [with the only bit in the byte set to one of the least significant bit, bit 7.](#)

This protocol specifies that all data to be transmitted and received for control and data frames shall always be using an integral number of 4 byte quadlets. A quadlet is a series of 4 bytes within a quadlet, the most significant byte is that which is transmitted first and the least significant byte is that which is transmitted last, as shown below.

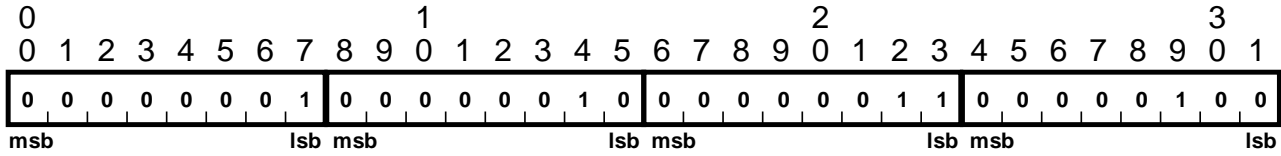

Figure 3.2 - Byte ordering within a quadlet

For the above figure, this would represent a quadlet holding four byte array of 1, 2, 3, 4 decimal. Also the byte on the left is the first transmitted, with subsequent bytes being transmitted from left to right. This specification does not specify which bit within each byte is transmitted first as that is part of the lower layer LAN specification such as 802.3 or 802.11.

A quadlet may contain bit fields of any length between 1 and 32 bits transmitted or received as a series of bytes. When a field spans more than one byte, the point where it spans the byte is shown as a large tick mark as follows:

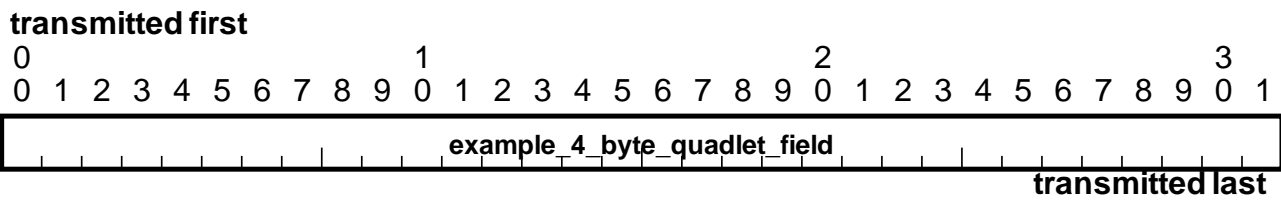

Figure 3.3 - Example 4 byte quadlet field diagram

For 64 bit fields that need to be contained in more than one quadlet, they are still transmitted and received as a series of 8 bytes, but for this document are shown in diagrams as follows:

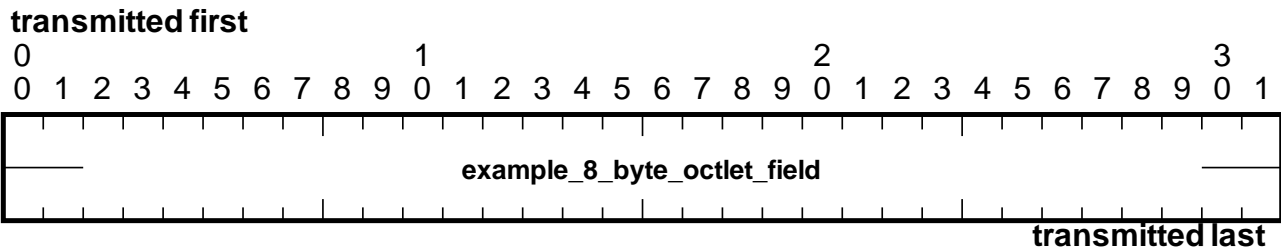

Figure 3.4 - Example 8 byte octlet field diagram

When block transfers take place that are not quadlet aligned or not an integral number of quadlets, no assumptions can be made about the ordering (significance within a quadlet) of bytes at the unaligned beginning or fractional quadlet end of such a block transfer, unless an application has knowledge (outside of the scope of this specification) of the ordering conventions of the other bus.

3.5.1 Field value conventions

This document describes values of fields. For clarity, names can be associated with each of these defined values, as illustrated in [Table 3.1](#). A symbolic name, consisting of upper case letters with underscore separators, allows other portions of this document to reference the value by its symbolic name, rather than a numerical value.

Table 3.1 wrap field values

Value	Name	Description
0	WRAP_AVOID	Frame is discarded at the wrap point
1	WRAP_ALLOW	Frame passes through wrap points.
2-3	—	Reserved

Unless otherwise specified, reserved values are reserved for the purpose of allowing extended features to be defined in future revisions of this standard. Devices conforming to this version of this standard do not generate reserved values for fields, and process fields containing reserved values as though the field values were not supported. The intent is to ensure default behaviors for future-specified features.

A field value of TRUE shall always be interpreted as being equivalent to a numeric value of 1 (one), unless otherwise indicated. A field value of FALSE shall always be interpreted as being equivalent to a numeric value of 0 (zero), unless otherwise indicated.

3.6 Informative notes

Informative notes are used in this standard to provide guidance to implementers and also to supply useful background material. Such notes never contain normative information, and implementers are not required to adhere to any of their provisions. An example of such a note follows.

NOTE—This is an example of an informative note.

4. Abbreviations and acronyms

This document contains the following abbreviations and acronyms:

1394TA	IEEE 1394 Trade Association (www.1394ta.org)
IEEE	Institute of Electrical and Electronics Engineers, Inc. (www.ieee.org)
ACK	acknowledge
ANSI	American National Standards Institute (www.ansi.org)
AP	(wireless LAN) access point
AV	audio/video
AVB	audio/video bridging
AVBTP	audio/video bridging transport protocol
AV/C	audio video control protocol (from 1394 Trade Association)
BC	boundary clock
BMC	best master clock
BMCA	best master clock algorithm
BSS	basic service set
cd	control/data
CFI	canonical format indicator
CID	channel identifier
CIP	common isochronous packet
cntl	control
CoS	class of service
CRC	cyclic redundancy check
CTP	command transport protocol
D	draft
DA	destination MAC address
DRM	digital rights management
DSS	distribution system service
DTCP	digital transmission content protection (www.dtcp.org)
DTLA	Digital Transmission Licensing Administrator (www.dtcp.org)
DVCR	digital video-cassette recorder
E2E	end to end
EISS	enhanced internal sublayer service
ESS	extended service set
EUI	IEEE Extended Unique Identifier
fc	fragmentation control
GASP	global asynchronous stream packet

GM	grandmaster	1
GMT	Greenwich mean time	2
GPS	global positioning (satellite) system	3
HD	high definition	4
hdr	header	5
IEC	International Electrotechnical Commission (www.iec.ch)	6
IEEE	Institute of Electrical and Electronics Engineers (www.ieee.org)	7
IETF	Internet Engineering Task Force (www.ietf.org)	8
IP	Internet protocol	9
IS	integration service	10
ISO	International Organization for Standardization (www.iso.org)	11
IWU	interworking unit	12
kHz	kilohertz (thousand cycles per second)	13
LAN	local area network	14
LLC	IEEE 802.2 logical link control	15
LLDP	IEEE link layer discovery protocol	16
lsb	least significant bit	17
LSB	least significant byte	18
LMI	layer management interface	19
M	mandatory	20
MAAP	MAC address acquisition protocol	21
MAC	media access control	22
MACsec	media access control security	23
MHz	megahertz (million cycles per second)	24
MPEG	Moving Pictures Expert Group (http://www.chiariglione.org/mpeg/)	25
MS	master to slave	26
msb	most significant bit	27
MSB	most significant byte	28
MTU	maximum transmission unit size	29
N/A	not applicable	30
NTP	network time protocol (www.ietf.org/rfc/rfc1305.txt)	31
O	optional	32
OC	ordinary clock	33
OUI	IEEE organizationally unique identifier	34
P	preliminary	35
P2P	peer to peer	36
PAR	project authorization request	37
		38
		39
		40
		41
		42
		43
		44
		45
		46
		47
		48
		49
		50
		51
		52
		53
		54
		55
		56

1	PCP	priority code point
2		
3	PICS	protocol implementation conformance statement
4	PLL	phased lock loop
5	PTP	precision time protocol
6		
7	QoS	quality of service
8		
9	Rsv, res	reserved
10	S Bridge	IEEE 802.1AS bridge
11	SD	standard definition
12		
13	SI	international system of units
14		
15	SID	source identifier
16	SM	slave to master
17		
18	src	source
19	SRP	stream reservation protocol
20		
21	STA	(wireless LAN) station
22	TAI	temps atomique international (international atomic time)
23		
24	TBD	to be done (or determined)
25	TC	transparent clock
26		
27	TG	task group
28	TLV	type, length, value
29		
30	TPID	tagged protocol identifier
31	TS	timestamp
32		
33	tv	timestamp valid
34		
35	UTC	coordinated universal time
36	VID	VLAN identifier
37	VLAN	Virtual Local Area Network
38		
39	WG	working group
40		
41	WLAN	wireless local area network
42	X	prohibited
43		
44	XTS	cross timestamp
45		
46		
47		
48		
49		
50		
51		
52		
53		
54		
55		
56		

5. AVBTP base protocol

<<Editor’s note: This section will define the “base protocol” such that 61883 type protocol, encapsulation, etc. will be an optional protocol to “run over AVBTP” and so that we can add additional new protocols in the future. This section is intended for formats, functions, etc. that are “common”>>

5.1 Overview

<<Editor’s note: Text TBD>>

5.1.1 General assumptions/operations

<<Editor’s note: This section and subsections is still mostly cut and paste from the assumptions document and needs further refinement, will be edited in future drafts of this document>>

5.1.1.1 Link bandwidth utilization

AVB class A together with AVB class B traffic cannot use more than 75% of a link’s bandwidth. The remaining 25% (or more) shall be reserved for non-AVB flows.

5.1.1.2 Functional device type names

AVBTP will have Talkers, Listeners and Controllers

- A Talker is the source of a stream
- A Listener is a receiver of a stream
- A Controller is a device that introduces and manages talkers and listeners, and manages groups of sessions.

Any physical device can be any combination of these

An AVBTP stream is between one talker and one or more listeners

5.1.1.3 Interoperation with 802.1 bridges

AVBTP will interoperate with AVB 802.1 bridges.

If a stream traverses a bridge that is not AVB 802.1 capable, than that stream’s bandwidth cannot be guaranteed, so interoperation with non AVB capable bridges is beyond the scope of this standard.

5.1.1.4 Point to point operation

AVBTP will be able to run in a point to point fashion when two AVBTP end stations are connected directly via an IEEE 802.3 Ethernet connection. [An AVBTP end station may use Link Layer Discovery Protocol in order to determine if it is operating a point to point Ethernet LAN or if it is communicating to an 802.1Q bridge.](#)

<< Editor’s question/comment: What about point to point wireless??>>

5.2 802.3 Media specific encapsulation

This section documents the specific generic encapsulation requirements when running AVBTP over IEEE 802.3 LANs. This covers the following fields:

- a) Destination MAC address: 48 bits
- b) Source MAC address: 48 bits
- c) 802.1Q protocol header: 4 bytes consisting of:
 - Tagged Protocol Identifier (TPID): 16 bits
 - Canonical Format Identifier (CFI): 1 bit
 - Priority Code Point (PCP): 3 bits
 - Virtual Local Area Network (VLAN) Identifier: 12 bits
- d) AVBTP Ethertype: 16 bits

For 802.1Q operation (VLAN tagged frames) the Ethertype field immediate following the source MAC address is known as the Tagged Protocol Identifier (TPID) field and is set to 8100_{16} . For this case the AVBTP Ethertype is at an offset 4 bytes past the start of this field.

[Figure 5.1](#) shows an AVBTP frame encapsulated within an 802.3 frame with an 802.1Q header (also known as an 802.1Q VLAN Tag field). [For 802.3 frames, this format is required for all AVBTP stream data frames and optional for AVBTP control frames.](#)

Figure 5.1 - AVBTP frame within an 802.3 frame with 802.11Q tag field

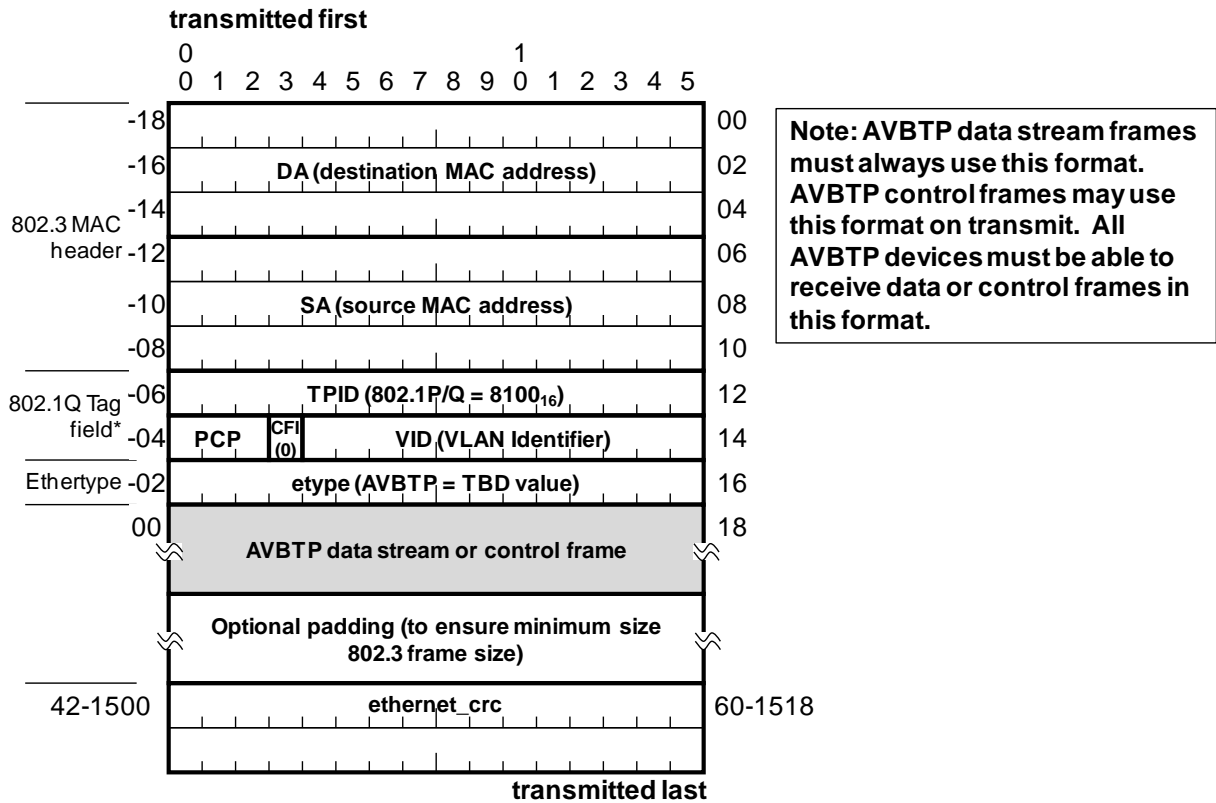
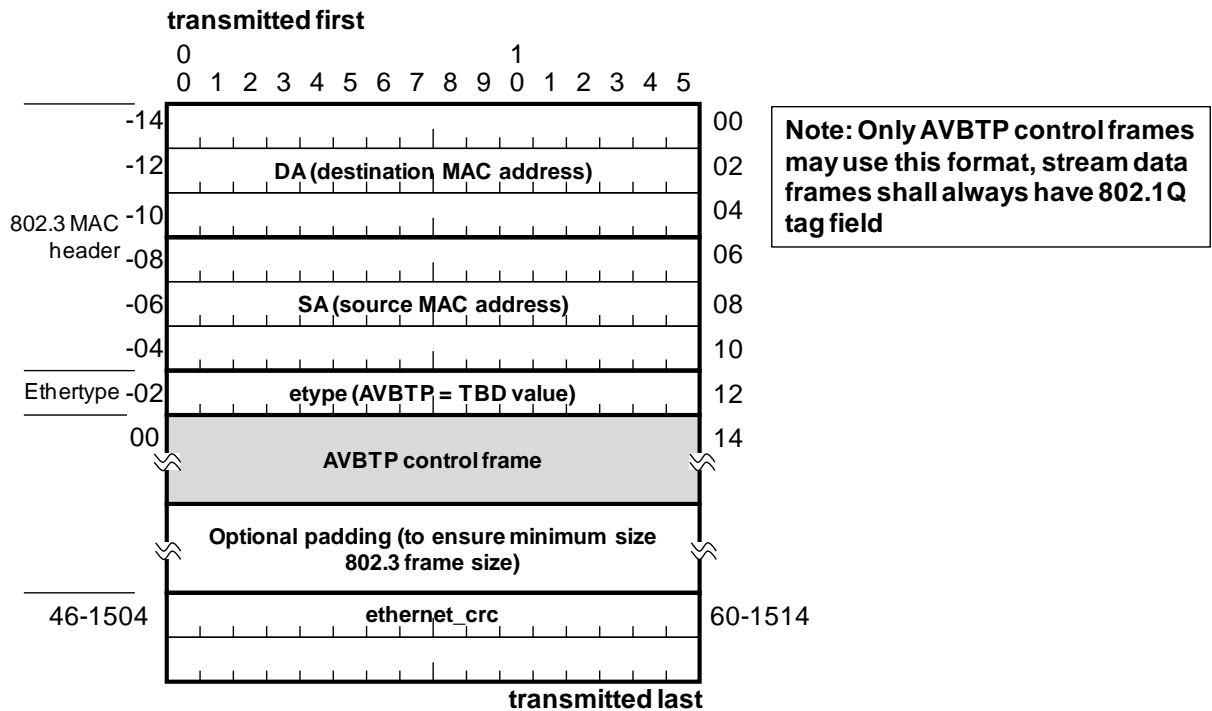

Figure 5.2 shows an AVBTP frame encapsulated within an 802.3 frame without an 802.1Q header. This format is optional for AVBTP control frames. This format is not allowed for AVBTP stream data frames as all stream data frames must be priority encoded for class A or class B traffic thus making the VLAN tag header mandatory.

Figure 5.2 - AVBTP frame within an 802.3 frame without an 802.1Q Tag field



5.2.1 802.3 Destination MAC address field

For AVBTP stream data frames, MAC Destination Addresses shall be unique for the Layer 2 network and may either be unicast or multicast addresses. IEEE 802.1Qat Multiple Stream Reservation Protocol (MSRP) shall be used to manage the destination MAC address and AVBTP stream ID of all stream data frames. Optionally, MAC Address Acquisition Protocol (MAAP) may be used in conjunction with 802.1Qat in order to guarantee that the MAC address does not conflict with another MAC address already in use by another AVBTP end station.

For AVBTP stream control frames, MAC Destination Address may be unicast, multicast or broadcast depending on the specification of the usage of each AVBTP control frame.

5.2.2 802.3 Source MAC address field

For AVBTP stream data frames, MAC Source Addresses shall indicate the senders MAC address of the stream data or control traffic. Per IEEE 802.3 rules, this address shall always be a unicast MAC address.

1
2
3
4
5
6
7
8
9
10
11
12
13
14
15
16
17
18
19
20
21
22
23
24
25
26
27
28
29
30
31
32
33
34
35
36
37
38
39
40
41
42
43
44
45
46
47
48
49
50
51
52
53
54
55
56

5.2.3 802.1Q header field

Depending on the subtype of the AVBTP frame, the 802.1Q header may or not be required based on the following rules:

- a) All talkers shall send [AVBTP](#) stream data frames with an 802.1Q header present. This is due to the fact that the PCP field is required to indicate whether the stream is a Class A or Class B stream.
- b) Talkers and controllers may send stream control frames with an 802.1Q header.
- c) All AVBTP compliant devices (talkers, listeners and controllers) shall be able to receive and process AVBTP stream data and control frames with an 802.1Q header present.

Additional rules for handling of 802.1Q headers may be listed in subsequent sections for current or future protocols that use AVBTP in current or future versions of this standard, but they shall not violate the above general rules, [nor shall they violate any rules as established in standard IEEE 802.1Q](#).

The following rules shall apply for fields in the 802.1Q header if it is present:

5.2.3.1 802.1Q tagged protocol identifier (TPID) field

All frames with and 802.1Q header field shall set the TPID field (1st Ethertype in the frame) 8100_{16} hexadecimal.

5.2.3.2 VLAN identifier (VID) field

The [VLAN identifier field](#) is used to indicate [the 802.1Q VLAN that an AVBTP frame is to be processed on](#).

[All](#) AVBTP stations shall be able to support a [VID](#) field value of zero to send or receive AVBTP frames.

AVBTP stations are recommended to support other VLAN [identifiers](#), but it is not required.

AVBTP stations not supporting VLANs must at least be able to process a received AVBTP frame with 802.1Q header and ignore the contents of that header.

If VLAN identification and knowledge is supported by an AVBTP station, it shall discard any received AVBTP frames with a VLAN ID for which it is not a member of the specified VLAN.

5.2.3.3 Canonical Format Indicator (CFI) field

For AVBTP, the CFI field shall be [set to zero by the talker and ignored by the listener](#).

5.2.3.4 Priority Code Point (PCP) field

For [all stream data frames](#), AVBTP talkers shall set the PCP value to the 802.1Qat specified default values for stream class A traffic or TBD for class B traffic, unless they are changed from the defaults by a network administrator. As priority values may be changed by IEEE 802 bridges, the PCP value will be ignored on reception by AVBTP listeners.

<<Editor's question: [Will there be any work prior to finalizing this spec on automatic setting/detecting of the correct PCP values for Class A and Class B traffic?](#) (see Z.2 [Need mechanism for getting PCP value for Class A and Class B streams](#))>>

[AVBTP control traffic shall use the value as specified by the associated protocol specific value \(e.g. 61883 over AVBTP\), but never shall use a value of assigned for class A or class B traffic.](#)

5.2.4 AVBTP Ethertype, 16 bits:

[All AVBTP frames shall use an Ethertype value of XXXX₁₆.](#)

<< Editor's note: That value will be put in this document per IEEE Ethertype assignment procedures, and not before then.>>

5.3 802.11 Media specific encapsulation

<<Editor's note: [This section has been TBD for a long time now. We need to have a committed volunteer to help the editor in filling this section out.](#)>>

1
2
3
4
5
6
7
8
9
10
11
12
13
14
15
16
17
18
19
20
21
22
23
24
25
26
27
28
29
30
31
32
33
34
35
36
37
38
39
40
41
42
43
44
45
46
47
48
49
50
51
52
53
54
55
56

5.4 AVBTP frame common header format

This section documents the fields [contained in the first 12 bytes of header](#) that are common to all AVBTP [stream data and control](#) frames. [These 12 bytes consist of the](#) following fields:

- a) First byte:
 - **cd** (control/data) field (cd) indicator: most significant 1 bit ([bit 0](#))
 - **subtype** field: remaining 7 bits
- b) Second byte:
 - **sv** (Stream ID valid) indicator: most significant 1 bit ([bit 0](#))
 - **subtype_data1** field: remaining 7 bits
- c) [Third and fourth byte:](#)
 - **subtype_data2** field: 16 bits
- d) [Remaining eight bytes:](#)
 - **stream_id** field: 64 bits

The following figure shows these fields [with offset zero\(00\) shown as the first byte of the AVBTP frame which is the first byte after the Ethertype field in the 802.3 or 802.11 frame:](#)

Figure 5.3 —AVBTP frame common header fields

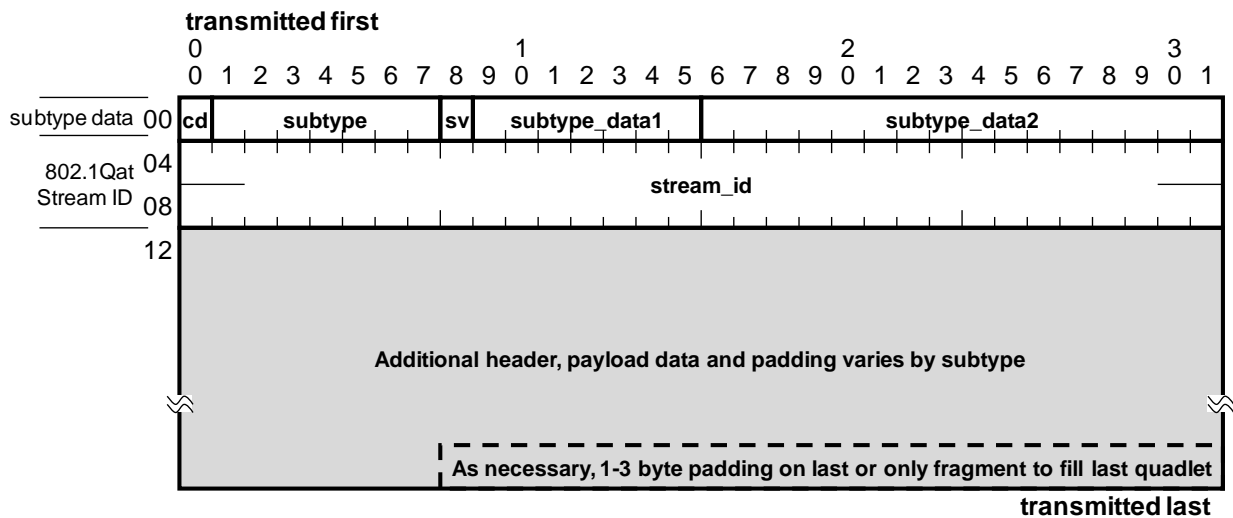

5.4.1 cd (control/data indicator) field

The **cd** bit indicates whether this AVBTP frame is a control or [stream](#) data frame

If the **cd** bit is zero, then this frame is an AVBTP stream data frame. See 5.6 below for additional encapsulation and protocol rules when this bit is set to zero. Only AVBTP talkers can set this field to zero as only talkers can send AVBTP stream data frames. If this field is set to zero, then for 802.3 frames, the talker shall ensure the frame is sent with an 802.1Q VLAN tag header present with the appropriate values for the TPID, PCP, CFI and VID fields.

If this field is set to one, then this frame is an AVBTP control frame. See 5.5 below for additional encapsulation and protocol rules when this bit is set to one. Any AVBTP station that sends control frames may set this bit to one.

1
2
3
4
5
6
7
8
9
10
11
12
13
14
15
16
17
18
19
20
21
22
23
24
25
26
27
28
29
30
31
32
33
34
35
36
37
38
39
40
41
42
43
44
45
46
47
48
49
50
51
52
53
54
55
56

5.4.2 subtype field

The 7-bit **subtype** field is used to identify the protocol running over AVBTP. Each protocol defines its use of AVBTP encapsulation within the rules established for common header formats for control and data frames.

Currently defined subtype values are listed in [Table 5.1](#) below:

Table 5.1 -- AVBTP *subtype* values

Hexadecimal Value	FUNCTION	Meaning
00 ₁₆	61883_IIDC_SUBTYPE	61883/IIDC over AVBTP protocol
01 ₁₆ -7E ₁₆	-	Reserved for future protocols
7F ₁₆	PROPRIETARY_SUBTYPE	Proprietary/Experimental over AVBTP

Subsequent parsing of AVBTP frames shall be based on a combination of the values contained within the subtype and **cd** fields.

5.4.3 sv field

The **sv** field is used to indicate whether the 64 bit **stream_id** field contains a valid IEEE 802.1Qat stream ID or not.

The bit is set to one(1) if the stream ID is a valid stream ID

The bit is set to zero(0) if the stream ID is not valid.

For more details on valid combinations of the **stream_id** and **sv** fields see 5.4.6 below.

5.4.4 subtype_data1 field

The **subtype_data1** field consists of the remaining 7 bits of the byte containing the **sv** field and is used to carry protocol specific data based on the **subtype** and **cd** field values.

5.4.5 subtype_data2 field

The **subtype_data2** field consists of the two bytes (16 bits) following the **subtype_data1** [field](#) and is used to carry protocol specific data based on the **subtype** and **cd** field values.

5.4.6 stream_id field

If the **sv** field is set to one(1), then the **stream_id** field shall contain the 64 bit IEEE 802.1Qat stream ID associated with the frame.. This field shall be used for stream identification. The field shall be present in all AVBTP frames.

All AVBTP stream data frames shall contain a valid 64 bit IEEE 802.1Qat Stream ID in the **stream_id** field and shall set the **sv** (Stream ID Valid) bit to one(1).

AVBTP control frames relating to an individual stream shall contain a valid 64 bit IEEE 802.1Qat stream ID with the **sv** bit set to one.

AVBTP control frames not related to an individual stream should set the **stream_id** field to the NULL_STREAM_ID Value and shall set the **sv** bit to zero(0).

Note – Setting of the **stream_id** field to a consistent NULL_STREAM_ID is recommend instead of required as the NULL_STREAM_ID is intended for consistency and to avoid confusion for users such as those debugging AVBTP frame traces (i.e. so they don't see old data, or valid stream IDs, etc.). AVBTP end stations when receiving AVBTP frames with the **sv** bit set to one(1) shall ignore the entire contents of the **stream_id** field regardless of its value.

Valid stream IDs shall be allocated, managed and released using procedures as defined in IEEE 802.1Qat.

1
2
3
4
5
6
7
8
9
10
11
12
13
14
15
16
17
18
19
20
21
22
23
24
25
26
27
28
29
30
31
32
33
34
35
36
37
38
39
40
41
42
43
44
45
46
47
48
49
50
51
52
53
54
55
56

5.5 AVBTP common control frame header format

This section documents the fields contained in the first 12 bytes of header when the **cd** bit is set to one(1) indicating that this AVBTP frame is an AVBTP control frame. These 12 bytes consist of the following fields:

a) First byte:

- **cd** (control/data indicator) field as documented in 5.4.1 above; for AVBTP control frames, this field is set to one(1)
- **subtype** field: remaining 7 bits

b) Second byte:

- **sv** (Stream ID valid) indicator: most significant 1 bit (bit 0)
- **control_data1** field: remaining 7 bits

c) Third and fourth byte:

- **status** field: most significant 5 bits of the third byte
- **control frame length** field: 11 bits total consisting of the least significant 3 bits of the third byte and all 8 bits of the fourth byte.

d) Remaining eight bytes:

- **stream id** field: 64 bits

The following figure shows these fields with offset zero(00) shown as the first byte of the AVBTP control frame which is the first byte after the Ethertype field in the 802.3 or 802.11 frame:

Figure 5.4 - Control frame common fields

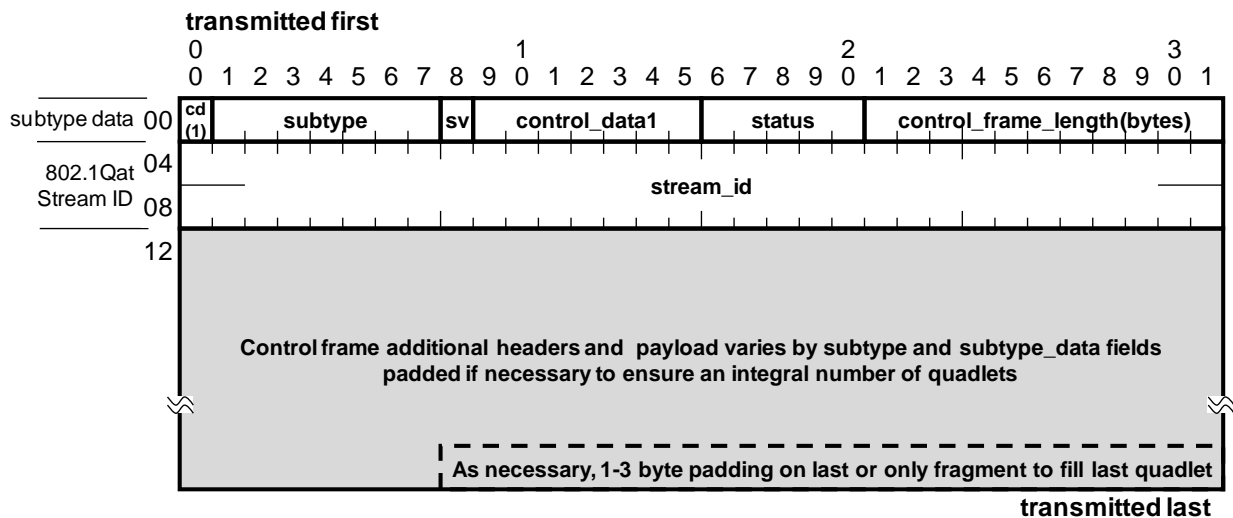

5.5.1 control_data1 field

The 7 bit **control_data1** is available for use by the given control protocol as specified by the **subtype** field. This field may be used by the control protocol as it sees fit, but is recommended for use for data such as command codes, events, etc. If not used by the given control frame, then this field shall be set to zero(0).

5.5.2 status field

The 5 bit **status** field is available for use by the given control protocol as specified by the **subtype** field. This field may be used by the control protocol as it sees fit, but is recommended for use for data such as status values, flags, etc. If not used by the given control frame, then this field shall be set to zero (0).

5.5.3 control_data_length field

The 11 bit **control_data_length** field is used to contain the unsigned control frame payload length in bytes of all valid data bytes contained in the quadlets following the **stream_id** field in the AVBTP control frame header.

1 to 3 pad bytes shall be added at the end of the control frame payload area as necessary to ensure that an integral number of quadlets are in the [AVBTP](#) control frame.

The maximum value for this field shall be 1488 decimal.

1
2
3
4
5
6
7
8
9
10
11
12
13
14
15
16
17
18
19
20
21
22
23
24
25
26
27
28
29
30
31
32
33
34
35
36
37
38
39
40
41
42
43
44
45
46
47
48
49
50
51
52
53
54
55
56

5.6 AVBTP common stream data frame header format.

AVBTP stream data is designed to standardize common use fields for source timestamping and for packet length. These fields are standardized for all AVBTP frames where the **cd** field is set to zero.

The AVBTP common stream data header format consists of the following fields after the subtype and in the following [byte](#) order:

- a) [subtype_data1](#) field: 8 bit byte with the following subfields defined when **cd** field equals zero:
 - [sv](#) ([stream_id field](#) valid) most significant 1 bit ([bit 0](#)) of this byte
 - [gv](#) ([gateway_info field](#) valid), [second least significant 1 bit \(bit 6\) of this byte](#)
 - [tv](#) ([avbtp_timestamp field](#) valid): least significant 1 bit ([bit 7](#)) of this byte
 - [sd_reserved1](#): remaining [5 bits \(bits 1 through 5\)](#) of this byte
- b) [subtype_data2](#) field: 16 bits with the following subfield defined when **cd** field equals zero:
 - [sd_reserved2](#): 8 bits
 - [gm_info](#) field: 8 bit byte with the following subfields
 - i) [gm_discontinuity](#): [most significant 7 bits \(bits 0 through 6\) of this byte](#)
 - ii) [h](#): holdover: [least significant 1 bit \(bit 7\) of this byte](#)
- c) [stream_id](#) field: 64 bits
- d) [avbtp_timestamp](#): 32 bits
- e) [gateway_info](#): 32 bits
- f) [packet_data_length](#): [16](#) bits
- g) [protocol_specific_packet_header](#): 16 bits
- h) [stream_payload_data](#): 0 to n quadlets (where n does not exceed maximum frame size allowed by the layer 2 LAN)

Figure 5.5 --AVBTP common stream data header format (cd field set to zero)

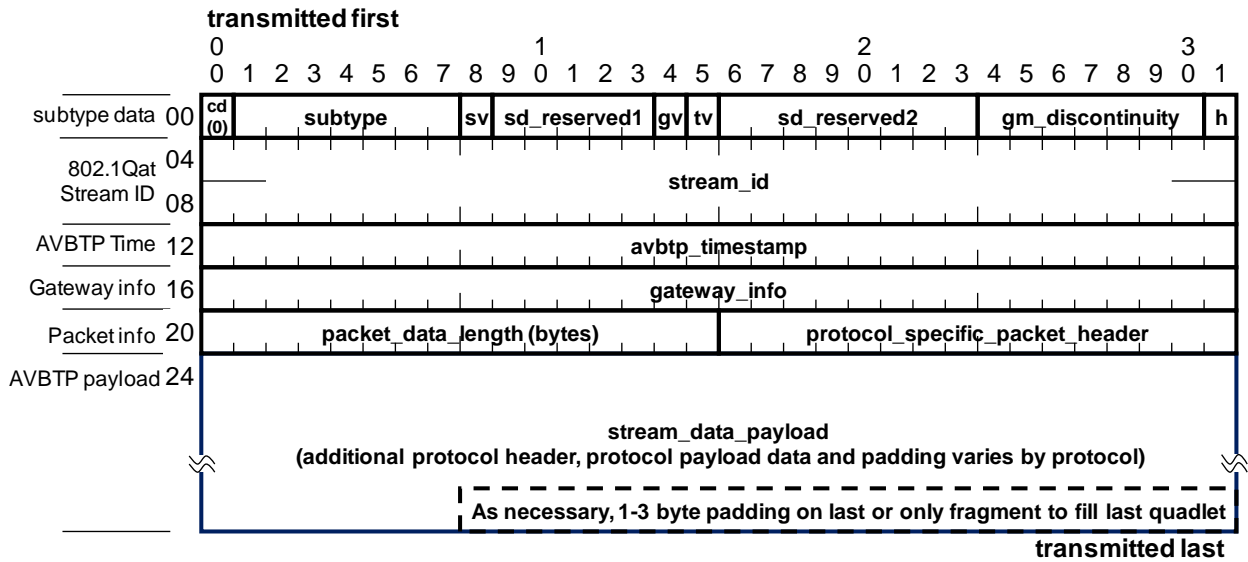

5.6.1 subtype_data1 field subfields

The **subtype_data1** field for AVBTP stream data (when the **cd** field is set to zero) has the following subfields defined.

- Most significant bit (**bit 0**) for **sv** (**stream_id** field valid) (see 5.4.3 above)
- Second least significant bit (**bit 6**) for **gv** (**gateway_info** field valid) bit
- Least significant bit (**bit 7**) for **tv** (**avbtp_timestamp** field valid) bit
- remaining 5 bits reserved (**sd_reserved1** subfield).

5.6.2 gv: (gateway_info field valid) subfield

The **gateway_info** field valid (**gv**) field is a one bit field used to indicate the validity of the **gateway_info** field.

This field and the **gateway_info** field are intended for use for AVBTP gateway to gateway communication.

AVBTP end stations that do not have an AVBTP gateway function shall set this field to zero(0) on transmit and ignore this field on receive.

AVBTP gateways have an AVBTP gateway function when acting as a talker shall:

Set this field to zero(0) on transmit if other gateways on the LAN segment are to ignore the **gateway_info** field on reception of the stream data frame.

Set this field to one(1) on transmit if other gateways on the LAN segment are to process the **gateway_info** field on reception of the stream data frame.

For an example of how the **gv** and **gateway_info** fields are processed, see Annex B below.

5.6.3 tv: (avbtp_timestamp field valid) subfield

The source timestamp valid (**tv**) field is a one bit field used to indicate the validity of the **avbtp_timestamp** field time value.

1 If the timestamp valid bit is set to zero by the AVBTP talker, then this field shall indicate that the **avbtp_timestamp** field
2 contains no data and therefore shall be ignored by an AVBTP listener.

3
4 If the timestamp valid bit is set to one by the AVBTP talker, then this field shall indicate that the **avbtp_timestamp** field
5 is valid.

6
7 For how the **avbtp_timestamp** field is interpreted and processed see 5.6.7.

10 5.6.4 gm_discontinuity field

11 The **gm_discontinuity** field indicates a known or possible discontinuity in 802.1AS time. The **gm_discontinuity** field is
12 stream specific. On stream creation the **gm_discontinuity** field shall be set to a random value. **gm_discontinuity** shall
13 be incremented by 1 whenever a signaled or possible discontinuity is indicated from 802.1AS. These indications include,
14 but are not limited to:

- 16 a) Discontinuity in absolute time
- 17 b) Discontinuity in frequency
- 18 c) Loss of Grandmaster clock
- 19 d) Election of new Grandmaster clock

22 5.6.5 h (holdover) field

23
24 **<<Editor's note: this is a new concept and field as discussed at the Beaverton Oregon face to face meeting. This
25 field needs better text and clarification to be added in the next version of the draft>>**

26
27 The 1 bit **h** field shall be set anytime the AVBTP timestamp field in this stream is based off of some local clock instead of
28 the 802.1AS based clock (i.e. in holdover clock based on the 802.1AS time from the previously known good grandmaster
29 time). This is used by talkers to indicate that the timestamps may not globally synchronized with network time and is
30 used by listeners to also use holdover time as necessary until all systems are probably running on the same grandmaster.

33 5.6.6 stream_id (802.1Qat stream identifier) field

34
35 The stream ID field is the same field as specified in 5.4.6 above. For AVBTP stream data frames, it shall always contain a
36 valid 802.1Qat stream ID.

39 5.6.7 avbtp_timestamp field

40
41 The 32 bit **avbtp_timestamp** field shall express presentation time related to the 802.1AS Global Clock if the timestamp
42 valid bit is set to one. The **avbtp_timestamp** represents the low order 802.1AS time converted to nanoseconds. The
43 **avbtp_timestamp** rolls over approximately every 4 seconds.

44
45 If the source timestamp valid bit is zero, then the contents of the **avbtp_timestamp** field is undefined and should be
46 ignored.

49 5.6.8 gateway_info field

50
51
52 The 32 bit **gateway_info** field is used by gateway and interworking units to allow conversion and transport of
53 audio/video data and control between AVBTP networks and other audio/video networks. **This field and the gy field are
54 intended for AVBTP gateway to gateway communication.** One use is described in Annex B of this document for IEEE
55 1394 IEC 61883 to IEEE 1722 AVBTP IEC 61883 interworking.

Native AVBTP end stations not participating in [AVBTP gateway functions](#) shall set this field to zero on transmit and ignore this field on receive.

5.6.9 packet_data_length field

The 16 bit **packet_data_length** field is to indicate the unsigned count of stream frame payload length in bytes of all valid data bytes contained in the quadlets following the **protocol_specific_packet_header** field in the AVBTP stream data frame header.

1 to 3 pad bytes shall be added at the end of the stream data frame payload area as necessary to ensure that an integral number of quadlets is in the control frame.

The maximum value for this field shall be 1476 decimal.

Note – This field is sized at a full 16 bits to allow for [easier frame size handling for AVBTP gateway functions for other networks such as 1394 which allows larger frame sizes than is allowed on 802.3 networks and also matches the position and function relative to other fields of the IEEE 1394 equivalent field for isochronous frames. As mentioned above, no frame on an AVBTP networks may be larger than a single maximum frame as specified by the lower layer IEEE 802 LAN standard.](#)

5.6.10 protocol_specific_packet_header field

[The 16 bit protocol_specific_packet_header field is to carry 16 bits of protocol specific data as specified by the protocol subtype.](#)

[For an example of how this field is used by the 61883 over AVBTP subtype see 6.2 below](#)

5.6.11 stream_data_payload field

[The stream_data_payload field consists of 0 to n quadlets of additional protocol specific data with the valid data length is indicated by the packet_data_length field.](#)

[1 to 3 pad bytes shall be added at the end of the stream data frame payload area as necessary to ensure that the AVTP frame always consists of an integral number of quadlets.](#)

[The maximum byte length for this field shall be 1476 decimal.](#)

[For an example of how this field is used by the 61883 over AVBTP subtype using CIP encapsulation see 6.4 below.](#)

<<Editor’s note: Need to add text recommend smoothing of AVBTP into similar size packets to make minimum packet size per interval better. This may be a good place to add text and/or we could have a separate section talking about packets per observation interval and how to best handle transmitting “evenly”.>>

5.7 Timing and synchronization

5.7.1 General

AVBTP defines a presentation time to achieve timing synchronization between talker and listener(s). The presentation time represents in nanoseconds the IEEE 802.1AS wall clock time when the data contained in the packet is to be presented to the AVBTP client at the listener(s).

AVBTP presentation time is used as a reference to synchronize any necessary media clocks and to determine when the first sample of a stream is presented to the client. Because media clocks vary with audio/video types the exact usage of the AVBTP presentation time is media format dependent.

5.7.2 AVBTP presentation time

The AVBTP presentation time is contained in the **avbtp_timestamp** field of AVBTP stream data frames.

The AVBTP presentation time may not be valid in every AVBTP packet. If an AVBTP packet contains a valid timestamp then the **tv** (Timestamp Valid) bit must be set to one.

The AVBTP presentation time represents the timestamp of the when the media sample was presented to AVBTP at the talker plus a delay constant to compensate for network latency. Unless otherwise negotiated between the talker and the listener the delay constant used to calculate the AVBTP presentation time is 2,000,000 nanoseconds (2 milliseconds).

The AVBTP presentation time as received by the listener(s) in **avbtp_timestamp** field should be utilized to synchronize the media clock of the listener to the talker. Since the AVBTP presentation time is directly related to the IEEE 802.1AS global time it may also be used to synchronize multiple talkers and listeners.

5.7.3 gm_discontinuity

Although the 802.1AS wall clock time is intended to be stable, it is possible for there to be discontinuities in the 802.1AS wall clock time. These could be due to events such as to changes the identity of the 802.1AS Grandmaster clock or changes in the timing source of the Grandmaster clock.

To aid in compensating for discontinuities in the 802.1AS time, all AVBTP stream data frames contain a **gm_discontinuity** field. The **gm_discontinuity** field is initialized to the random value on stream creation. The **gm_discontinuity** field of every subsequent AVBTP stream data frame shall contain the same value until a discontinuity is indicated by 802.1AS. When the actual or possible discontinuity occurs, the talker then increments the **gm_discontinuity** field by 1, after which all subsequent packets shall contain the new **gm_discontinuity** field. This process then repeats for every subsequent indication of an actual or possible discontinuity as indicated by IEEE 802.1AS.

When a talker detects a discontinuity, either from an 802.1AS indication or simple observation, it is required to increment the **gm_discontinuity** field by 1. This indicates to the listener(s) of the stream that the AVBTP presentation times contained in the **avbtp_timestamp** field may for a limited period of time not correspond to the 802.1AS wall clock and the listener should enter holdover mode.

When a listener detects that the **gm_discontinuity** field has changed or detects a discontinuity, either from an 802.1AS indication or simple observation, it should stop attempting to correlate AVBTP presentation time to 802.1AS wall clock time for one Maximum Holdover time. It is possible that the **gm_discontinuity** field could be incremented multiple times during one 802.1AS Grandmaster selection cycle. The listener should enter holdover mode, and begin timing the

maximum holdover time, on the first indication of a discontinuity. If other indications of discontinuity are detected before maximum holdover time has expired, these indications shall be ignored until maximum holdover time has expired.

The listener should exit holdover mode after either maximum holdover time has expired or if the listener is able through observation to determine that the 802.1AS time and presentation time in the stream data are consistent with each other.

The value of the **gm_discontinuity** field is only meaningful to a single talker and its associated listener(s).

1
2
3
4
5
6
7
8
9
10
11
12
13
14
15
16
17
18
19
20
21
22
23
24
25
26
27
28
29
30
31
32
33
34
35
36
37
38
39
40
41
42
43
44
45
46
47
48
49
50
51
52
53
54
55
56

5.8 Protocol layering and other required protocols

<<Editors note: Text TBD. Purpose of this section is to document “common” layering for AVBTP and also describe to the reader how IEC-61883 and proprietary/experimental fits into the common layering model and how others can be added in the future. Below is the current working diagram I have for “common” layers. Also I have not labeled this diagram in that I’m not sure if it will stay, change, be removed, etc.

<< Editor’s note: It was agreed at the Sandy Utah meeting that 802.1BA will specify the layering and we will point to the BA spec. Unfortunately for this working group, it appears that 802.1BA will not be ready in time for us to get our standard out. Therefore as discussed in the P1722 and AVB teleconferences, we will need to document what other protocols we require and also potentially any important options for those protocols that we will need to make required for our purposes. The text and diagrams below are a first cut effort to accomplish this and additional comments and contributions are requested by the editor.>>

This section documents other required protocols and standards required not specified in this transport level specification.

All AVBTP end stations shall support IEEE 802.1AS Precision Timing Protocol (PTP)[R5].

All AVBTP end stations shall support IEEE 802.1ak Multiple Registration Protocol (MRP) and Multiple MAC Address Registration Protocol (MMRP)[R8] as amended by IEEE 802.1ak Corrigendum 1[R9]. Support for Multiple VLAN Registration Protocol (MVRP) is optional.

All AVBTP end stations shall support IEEE 802.1Qat Multiple Stream Reservation Protocol (MSRP)[R6].

All AVBTP end stations shall support IEEE 802.1Qav

AVBTP end stations may support IEEE 802.1AB-Rev Link Layer Discovery Protocol (LLDP)[R10]

5.9 Service interface

<<Editor’s note: This section has been TBD for a long time. Based on the fact we have simplified the AVBTP interface to focusing on transport layer aspects and that as of today, there is only 61883 and proprietary formats and that service interface definitions are not part of IEEE 1394 or IEC 61883 documents, the editor recommends that at least for the first version of this standard, we do not specify a service interface.

Other opinions are welcome, but if we are to keep this section, a committed volunteer will be required to draft this section so the editor can include it as the editor does not plan to author it himself. >>

6. 61883/IIDC over AVBTP protocol

6.1 Overview

<< Editor's note: text below for Overview for now just excerpts from our assumptions document. I have not changed everything to language "proper" for a standard. >>

<<AVBTP meeting note: To help simplify the work we are looking into making IIDC out of scope. Will post this to the reflector and solicit for comments. Editor will stop work on IIDC until he hears back from the team.>>

AVBTP adapts the following 1394/61883 type protocols to run in an IEEE 802 environment.

- 61883-2: SD-DVCR data transmission
- 61883-4: MPEG2-TS data transmission
- 61883-6: Audio and music data transmission protocol
- 61883-7: Transmission of ITU-R BO.1294 System B
- 61883-8: Transmission of ITU-R BT.601 style Digital Video Data
- IIDC

AVBTP replaces the following 1394/61883 type protocols with ones appropriate to an IEEE 802 environment.

- 61883-1: Function Control Protocol (FCP) is replaced with Command Transport Protocol (CTP)

1
2
3
4
5
6
7
8
9
10
11
12
13
14
15
16
17
18
19
20
21
22
23
24
25
26
27
28
29
30
31
32
33
34
35
36
37
38
39
40
41
42
43
44
45
46
47
48
49
50
51
52
53
54
55
56

6.2 Common 61883/IIDC Stream data encapsulation

The 61883/IIDC stream data encapsulation is used for carrying IEC 61883 and IIDC stream data traffic over AVBTP networks.

This encapsulation uses a **cd** field of zero(0) and a **subtype** field of zero(0).

This encapsulation also uses the **protocol_specific_packet_header** to contain 4 fields that are common for both IIDC and IEC-61883 frames. These fields are modeled after IEEE 1394 and consist of the following:

- a) First byte:
 - **tag** field: most significant 2 bits of this byte
 - **channel** field: least significant 6 bits of this byte
- b) Second byte:
 - **tcode** field: most significant 4 bits of this byte
 - **sy** field: least significant 4 bits of this byte

These fields are shown in the figure below:

Figure 6.1 61883/IIDC common header fields

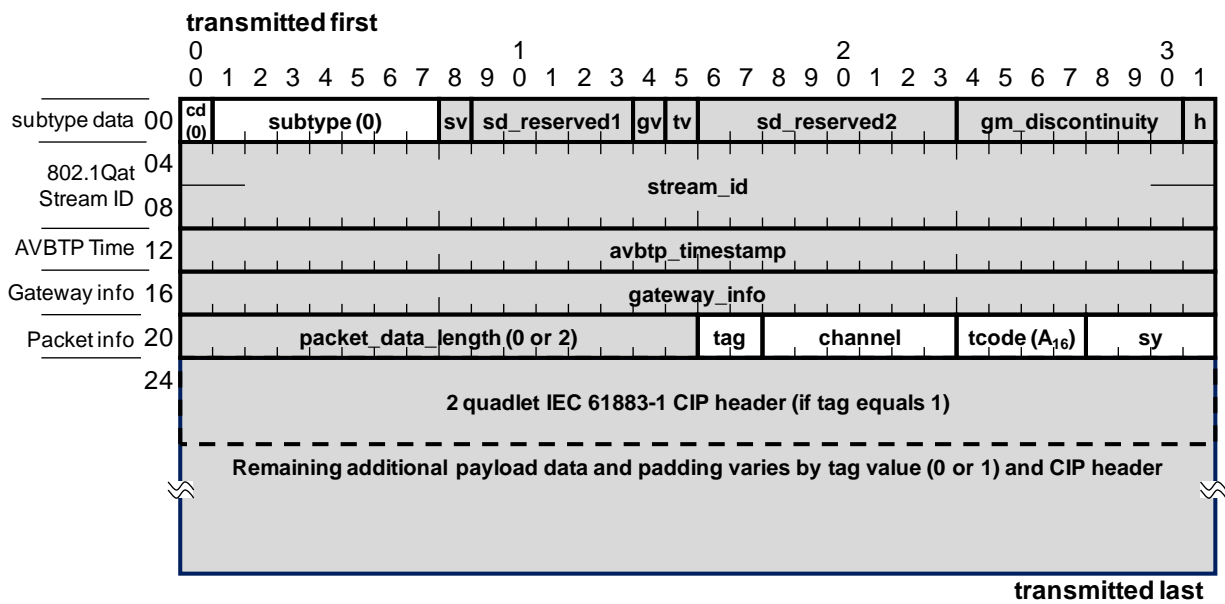

6.2.1 tag field

The 2-bit **tag** field follows the same meaning format and rules as specified by IEEE 1394. Of the four possible combinations for this field, the following values are supported or not supported as specified below.

Supported by AVBTP:

- 00₂: “data field unformatted” (used by Instrumentation & Industrial Digital Camera (IIDC) 1394 trade association specification)
- 01₂: CIP header is present

Not supported by AVBTP:

- 10₂: Reserved by IEEE 1394.1 clock adjustment
- 11₂: Global asynchronous stream packet (GASP) format (Used in 1394 for Serial Bus to Serial Bus bridges)

6.2.2 channel field

The 6-bit channel field follows the same meaning format and rules as specified by IEEE 1394. Of the four possible combinations for this field, the following values are supported as specified below.

- 0-30 & 32-63: originating channel ID from 1394 network via 1394/61883 to 1722/61883 gateway (as specified in Annex B below).
- 31: originating source is on AVB network (native AVB)

6.2.3 tcode (type code)

The 4-bit **tcode** field follows the same meaning format and rules as specified by IEEE 1394. For AVBTP, the only value supported shall be a fixed value of 1010₂ binary (A₁₆ hexadecimal, same as 1394 isochronous packet format) with the following rules for talkers and receivers.

- AVBTP talkers shall always set this field to A₁₆ hexadecimal on transmit
- AVBTP receivers shall always ignore this field on receive

<< Editor’s note: Kevin Gross had a comment suggesting that AVBTP end stations that support 61883 over AVBTP discard any frames with a type code other than 0x0A. The editor’s opinion is that gateways and AVBTP end stations should never generate any other type code, so a check is unnecessary and that based on other 1394 type codes, there is no need to handle the other ones (example, IP over 1394 and other best effort 1394 data should be handled by gateway or router functions). The editor is open to other opinions and we can discuss this at the Fremont face to face meeting on June 19, 2008>>

6.2.4 sy field

Use of the 4-bit **sy** field is application specific and therefore beyond the scope of this standard. Known industry standards that currently use this field are:

- IIDC [R16] (used for video start of frame indicator)
- Digital Transmission Content Protection (DTCP) (www.dtcp.com) [B3] [B4]

6.3 "Data field unformatted" encapsulation (used by IIDC)

<< Editor's note: This section and sub sections describe the variant where the tag field is set to 01₂ binary indicating that a CIP header follows. For tag value of 00₂ binary, the remaining data is format specific to IIDC (or other uses of "unformatted"?).>>

<< Editor's note, this section is still cut and paste from my PowerPoint based contribution and will be re-worked to put in an appropriate standards language and format in a future version of this specification>>

Figure 6.2 - 61883/IIDC frame header fields

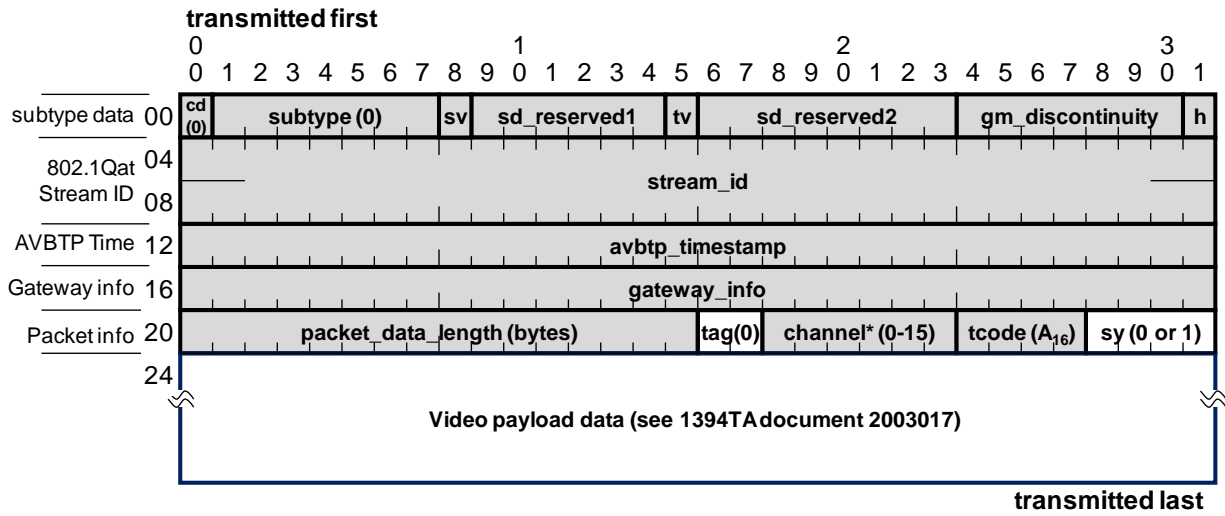

***Note: Current standard for IIDC restricts channel ID to 0-15**

6.4 IEC-61883 CIP encapsulation

<<Editor’s note: Text TBD. Need to say something that the subsections of this section only apply if the tag field is equal to 01₂ binary. Also need general intro text>>

Figure 6.3—CIP header and data fields, tag= 1, SPH = 0

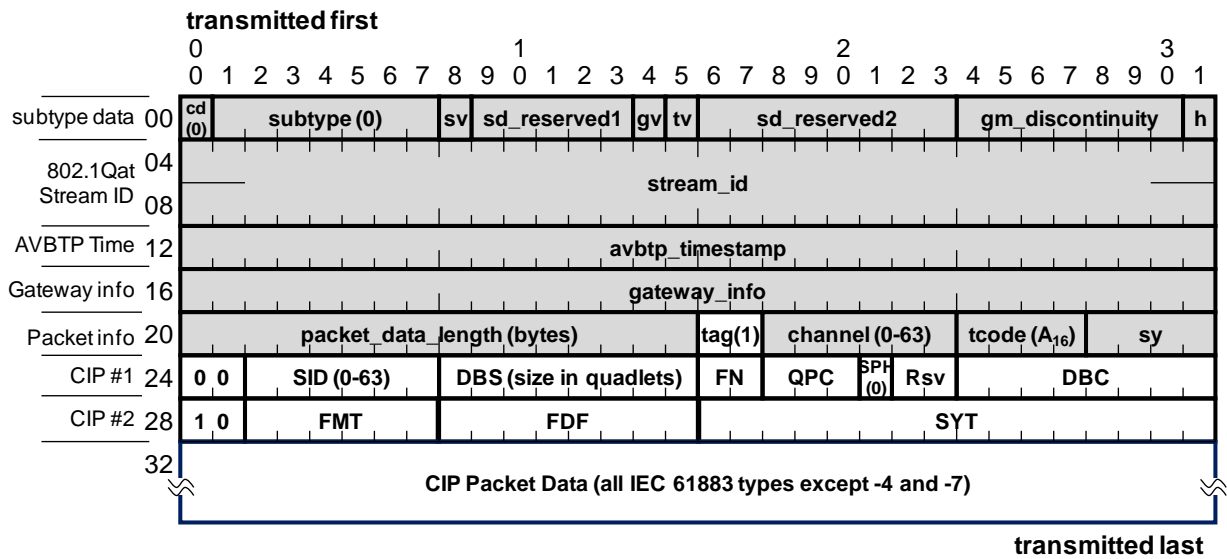
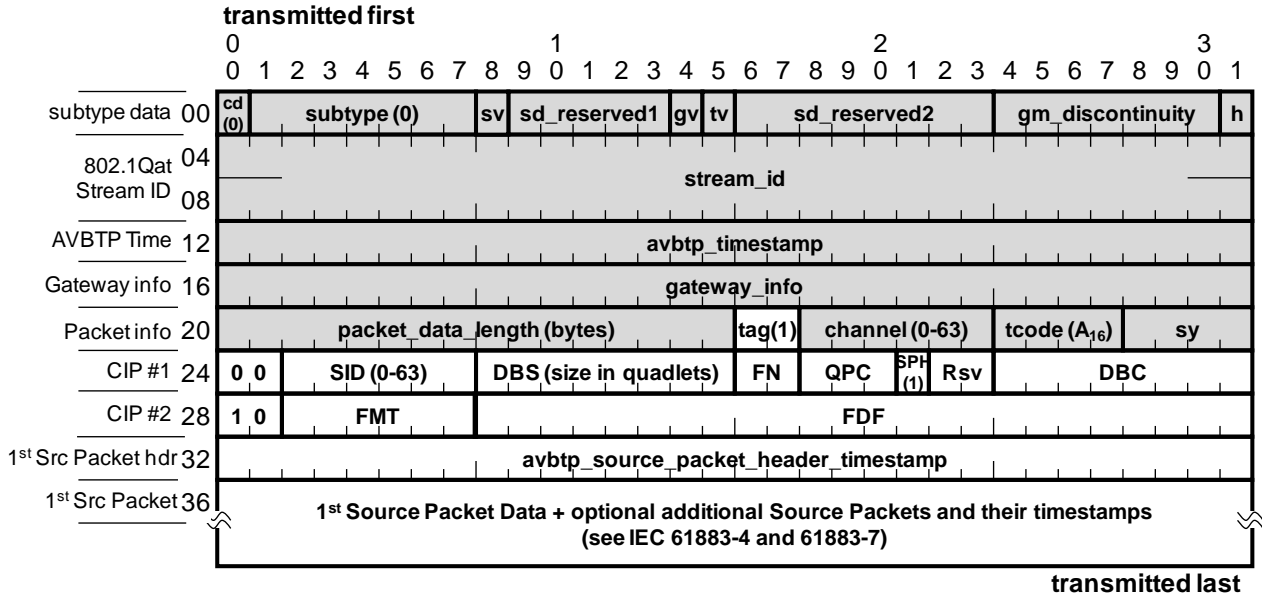

Figure 6.4—CIP header and data fields, tag=1, SPH = 1



6.4.1 CIP header 1st quadlet indicator

The 2 bit CIP header 1st quadlet indicator field has the same definition as defined in IEC 61883-1. AVBTP shall only support a fixed value of 00₂

<<Editors question: Is it OK for listeners to ignore this field on receive or should it be an error if there is another value??>>

6.4.2 SID (source ID) field

The 6 bit **SID** field has the same definition as defined in IEC 61883-1. For AVBTP, it shall use the following values.

- 0-62: originating Source ID from IEEE 1394 network (frame originated from a 1394/61883 to 1722/61883 interworking unit).
- 63: originating source is on AVB network

6.4.3 Data Block Size (DBS)

The 8-bit DBS field has the same definition as currently in 61883-1, size of Data Blocks in Quadlets

- 0: 256 quadlets
- 1-255: 1-255 quadlets

6.4.4 QPC (quadlet Padding count)

The 3-bit QPC field has the same definition as currently defined in 61883-1. For all types of 61883 as defined today, this field is always zero.

<<Editor's note: Assume that we should say that this field is not supported in any current protocols as defined and therefore if QPC is not zero, it is an error>>

6.4.5 FN (fraction number) field

The 2-bit FN field has the same definition as currently defined in 61883-1. This is currently only used in 61883-4 and 61883-7 (where also the SPH field is always set to one).

6.4.6 SPH (source packet header) field

The SPH bit has the same definition as currently defined in 61883. If set to one:

- Then application packet contains 61883-4 or 61883-7 (or future) source packets with source packet headers.

If set to zero

- Then application packet does not contain source packets (contains integer number of Data Blocks)

6.4.7 Rsv (reserved) field

The 2-bit has the same definition as currently defined in IEC 61883-1. It is reserved (currently not used by 1394/61883), set to zero on transmit, ignore on receive.

6.4.8 DBC (data block count) field

The 8 bit DBC field has the same definition as currently defined in IEC 61883-1. It contains the sequence number of the 1st data block in the packet. The DBC field shall not be set to a value that would cause the total byte AVBTP frame length to exceed a maximum payload size 802.3 of 1500 bytes (2 bytes of Ethertype plus 1498 bytes of payload) frame. This limits the total size of an AVBTP frame header plus payload of no more than 374 quadlets (1496 bytes). All frames of this format shall contain an integral number of data blocks as defined in IEC 61883-1.

6.4.9 CIP header 2nd quadlet indicator

The 2 bit CIP header 2nd quadlet indicator field has the same definition as defined in IEC 61883-1. For AVBTP it shall be fixed at 10₂ binary

6.4.10 FMT (stream format), field

The 6 bit FMT field has the same definition as currently defined in IEC 61883.

6.4.11 FDF (format dependent field)

The **FDF** field has the same definition as defined in IEC 61883. If the **SPH** field is set to 0, then this field is 8 bits in length. If the **SPH** field is set to 1, then this field is 24 bits in length.

6.4.12 SYT (synchronization timing) field (1394 cycle time based presentation time for SPH field equals 0)

The 24 bit **SYT** field is only present if the **SPH** field is set to a value of 0. This IEC 61883-1 defined field is present but not used by AVBTP end stations, it is only used by 1394/61883 to 1794/61883 interworking units (see Annex B below). AVBTP talker end stations shall set this field if present to $FFFFFF_{16}$ (the IEC 61883 no data timestamp value) on transmit and AVBTP listener end stations shall ignore this field on receive.

6.4.13 avbtp_source_packet_header_timestamp_field(802.1AS time based presentation time for SPH field equals 1)

If the SPH field is set to a value of one(1), then the AVBTP stream data frame contains one or more CIP source packets. Each CIP source packet contains a 32 bit timestamp as the first quadlet of the source packet followed by an integral number of quadlets as defined by the standard that defines the source packet format.

Currently defined supported formats that are supported by AVBTP are IEC 61883-4 and 61883-7.

IEC 61883-4 and 61883-7 as written define the source packet header quadlet to contain the presentation time of the packet based on IEEE 1394 cycle time.

AVBTP uses the same formats as defined in IEC 61883-4 and 61883-7, but it uses an IEEE 802.1AS based presentation time in the same format as defined for the **avbtp_timestamp** field which consist of presentation time as expressed as the least significant 32 bits of 802.1AS time.

<<Editor's note: We also need to define for AVBTP handling of -4 and -7 packets, what do we do with the avbtp_timestamp and tv fields. I believe there are two options:

- 1) Always set the tv field to zero and the avbtp_timestamp as don't care
- 2) Always set the tv field to one and copy the first source packet's avbtp_source_packet_header_timestamp into the avbtp_timestamp field.

I prefer option 1, but other comments are welcome.>>

6.5 61883 over AVBTP control frame format

Use of AVBTP frames with a subtype of zero(0) and a **cd** bit of one(1) is reserved for possible future versions of this specification.

6.6 Use of AV/C higher layer protocol in 61883 over AVBTP end stations

<<Editor's note: TBD. This section is intended to document that if you are going to use AV/C in conjunction with 61883 over AVBTP, then you need to run AV/C over UDP/IP as being specified by current work being done in the 1394 Trade Association>>

1
2
3
4
5
6
7
8
9
10
11
12
13
14
15
16
17
18
19
20
21
22
23
24
25
26
27
28
29
30
31
32
33
34
35
36
37
38
39
40
41
42
43
44
45
46
47
48
49
50
51
52
53
54
55
56

1
2
3
4
5
6
7
8
9
10
11
12
13
14
15
16
17
18
19
20
21
22
23
24
25
26
27
28
29
30
31
32
33
34
35
36
37
38
39
40
41
42
43
44
45
46
47
48
49
50
51
52
53
54
55
56

6.7 Protocol layering

<<Editors note: Text TBD. Purpose of this section is to document specific layering for 61883/IIDC over AVBTP>>

6.8 Session management

<<Editor's note: Text for this section is still cut and paste from AVBTP assumptions document and John Nels Fuller's contribution, needs further editing and design work>>

6.8.1 Overview

The 61883 over AVBTP session management protocols and procedures:

- Shall use LLDP (802.1AB), [MSRP](#) (802.1Qat) protocols as an integral part of the Session management protocols and procedures.
 - >> Thin layer, renaming of IEEE 802.1Qat service interface
 - >> Specify how to define bandwidth based on applications needs and pass to 802.1Qat as TSPEC
 - Reservation will require minimum Ethernet payload size for packet bandwidth reservation calculation, so 1722 or 802.1Qat will have to round up for filling of minimum size Ethernet Frame
- Shall provide a service interface to protocols such as Zeroconf
 - >> Informative annex??
- [AV/C applications shall use AV/C over UDP/IP as specified in 1394 Trade Association TA Document 2006021 Networking IEEE 1394 Clusters via UWB over Coaxial Cable - Part 3: FCP and CMP over IPv4](#) <<Editor's note: Work in progress, current draft is version 1.0, May 28, 2008>>[R19].

6.8.2 General Protocol operation

<< Editor's note: The structure for section 0 needs some work, to start with here are the consensus items from our teleconference meeting so far:

- **Function control protocol equivalent is IN**
 - [Will use AV/C over IP/UDP](#)
- **Plug control registers are OUT**
 - >> Will be part of work being done in 802.1Qat.
- **Connection management procedures are IN**
 - >>Should be a "thin" layer that maps to 802.1Qat
- **Stream ID Assignment is IN if not defined in 802.1**
 - Needed to complete our "Plugs" and CMP
- **IRM emulation is OUT**
 - >> Will be done in 802.1Qat
- **Service Discovery is IN for each command set supported**
 - (i.e. AV/C will recommend Bonjour, but other protocols will be allowed).
 - >>Informative Annex
- **AVBTP session management will use a Talker-Controller-Listener model for 61883 subtype protocol.**
 - >>Controller is part of the model but not part of 1722 (in application layer).

>>

6.9 Timing and Synchronization

6.9.1 General

Timing and synchronization for IEC 61883 over AVBTP is generally accomplished in the same manner as specified in 61883-1 through 61883-8 over IEEE 1394. The difference is the use of the **avbtp_timestamp** instead of the **SYT** field in the CIP header or the Timestamp field in the Source Packet header. The **SYT** and Timestamp fields may contain valid or invalid data and therefore must be ignored on receipt in an AVBTP node.

Usage of the timing and synchronization information included in the CIP header is generally consistent with the definition in the 61883 series of standards where the main differences are:

- The SYT field function formatted in seconds, cycle and cycle offset is replaced by the AVBTP timestamp field expressed in 802.1AS based nanoseconds..
- For protocols of 61883-4 and 61883-7 where the SPH field is set to one, then the 32 bit source packet header field for each source packet contains the associated presentation time of the source packet expressed in IEEE 802.1AS based nanoseconds instead of IEEE 1394 based seconds, cycle and cycle offsets.
- In the IEC 61883 series of specification the term “receiver” is used, whereas in this specification the term “listener” is used.
- In the IEC 61883 series of specification the term “transmitter” is used, whereas in this specification the term “talker” is used.
- IEEE 1394 on networks faster than 100 megabits per second allows CIP packets larger than can fit in a standard single IEEE 802.3 Ethernet frame. This standard does not, if an application needs to send more than data than can fit in a single Ethernet frame, it must generate multiple correctly formatted CIP packets each one that can fit in an 802.3 Ethernet frame.
- Some of the IEC 61883 series of specification sometimes have options that differentiate “professional”, “consumer-use” or “cost-sensitive” equipment. This standard does not, and if a device supports a given format, it must support all mandatory requirements as specified in this document.
- Not all formats and their associated protocol technologies, parameters, methods, etc. specified in the 61883 series of specification are supported by this specification (example 61883-6 allows for packed formatted audio data, this specification does not).

6.9.2 61883-2 timing and synchronization

61883-2 formatted frames shall follow the same timing and synchronization rules as defined in IEC 61883-2 section 6, but using IEEE 802.1AS time in the **avbtp_timestamp** frame field instead of IEEE 1394 based cycle time in the SYT field. AVBTP talkers shall set the CIP header SYT field to all ones for all transmitted CIP packets and AVBTP listeners shall ignore the SYT field.

The talker shall transmit a valid time stamp value in the AVBTP timestamp field once every video frame period. The time stamp shall be transmitted in an AVBTP frame that meets the following conditions:

- $\text{packet_arrival_time_L} \leq \text{time stamp value}$
- $\text{time stamp value} - \text{transmission_delay_limit} \leq \text{packet_arrival_time_F}$

where:

packet_arrival_time_F is the IEEE 802.1AS time when the first bit of the packet which has the time stamp has arrived at the listener;

packet_arrival_time_L is the IEEE 802.1AS time when the last bit of the packet which has the time stamp has arrived at the listener;

transmission_delay_limit = default value of 2,000,000 nanoseconds (2 milliseconds).

In case of Hx ($H = 1,2,4$) transmission, KH data blocks are transmitted in a video frame period M using K isochronous packets. Isochronous packet n contains H data blocks of nH , $nH+1$, ... and $(n+1)H-1$.

The isochronous packet n of a video frame period M shall be transmitted on the following conditions ($n = 0, \dots, K-1$):

- packet_arrival_time_L \leq nominal timing for isochronous packet n
- nominal timing for isochronous packet n - transmission_delay_limit \leq packet_arrival_time_F

where

packet_arrival_time_F is the cycle time when the first bit of the isochronous packet n has arrived at the receiver;

packet_arrival_time_L is the cycle time when the last bit of the isochronous packet n has arrived at the receiver;

K is the number of isochronous packets without empty packets in a video frame period.

$K = 250$ (525-60 system)

$K = 300$ (625-50 system)

Nominal timing for isochronous packet $n = T_M + (T_M + 1 - T_M) \times n/K$

T_M is the time stamp for video frame period M transmitted in the AVBTP timestamp field.

6.9.3 61883-4 timing and synchronization

The timing and synchronization of 61883-4 over AVBTP uses the same method as used in 61883-4 over IEEE 1394 networks in that the source packet header quadlet always contains a valid timestamp. In 61883-4 over AVBTP, this quadlet contains nanosecond 802.1AS based time instead of IEEE 1394 seconds, cycle and cycle offset time.

For 61883-4 formatted frames over AVBTP, section 4.3 of 61883-4 is replaced with the following:

The time stamp in the source packet header is used by listeners for reconstructing a correct timing of the TSPs at their output. The time stamp indicates the intended delivery time of the first bit/byte of the TSP from the listener output to the transport stream target decoder. The time stamp represents the 32 least significant bits of the IEEE 802.1AS at the talker at the moment the first bit/byte of the TSP arrives from the application, plus some offset. The offset is equal to the overall delay of the TSP between the moment of arriving (of the first bit) and the moment the TSP (first bit) is delivered by the receiver to the application. The default value of this offset is equal to 2,000,000 nanoseconds (2 milliseconds).

6.9.4 61883-6 timing and synchronization

<<Editors Note: packed AM24 and flow based rate control will not supported by AVBTP end stations>>

Replace Section 7.2 of 61883-6 with:

1 In the case where a CIP packet contains multiple data blocks, it is necessary to specify which data block of the CIP
2 corresponds to the IEEE 802.1AS based AVBTP time stamp.

3
4 The talker prepares the time stamp for the data block which meets this condition:

$$5 \quad \text{mod}(\text{data block count}, \text{SYT_INTERVAL}) = 0 \quad (1)$$

6
7
8 where

- 9 - data block count is the running count of transmitted data blocks;
- 10 - SYT_INTERVAL denotes the number of data blocks between two successive valid AVBTP timestamps which
11 includes one of the data blocks with a valid AVBTP timestamp. For example, if there are three data blocks
12 between two valid AVBTP timestamps, then the SYT_INTERVAL would be 4.

13
14 The listener can derive the index value from the DBC field of a CIP with a valid AVBTP timestamp using the
15 following formula:

$$16 \quad \text{index} = \text{mod}((\text{SYT_INTERVAL} - \text{mod}(\text{DBC}, \text{SYT_INTERVAL})), \text{SYT_INTERVAL}) \quad (2)$$

17
18
19 where

- 20 - index is the sequence number;
- 21 - SYT_INTERVAL denotes the number of data blocks between two successive valid AVBTP timestamps, which
22 includes one of the data blocks with a valid AVBTP timestamp;
- 23 - DBC is the data block count field of a CIP.

24
25
26
27 The listener is responsible for estimating the timing of data blocks between valid time stamps.

28
29 The method of timing estimation is implementation-dependent.

30
31 Replace Section 7.3 of 61883-6 with:

32
33 A data block contains all data arriving at the talker within an audio sample period. The data block contains all the data
34 which make up an "event".

35
36 The talker shall specify the presentation time of the event at the receiver. A receiver shall have the capability of
37 presenting events at the time specified by the transmitter.

38
39 If a function block receives a CIP, processes it and subsequently re-transmits it, the AVBTP timestamp of
40 the outgoing CIP shall be the sum of the incoming AVBTP timestamp and the processing delay.

41
42 The transmitter shall add TRANSFER_DELAY to the quantized timing of an event to construct the AVBTP timestamp.
43 The TRANSFER_DELAY value is initialized with the DEFAULT_TRANSFER_DELAY value. Note that for all talkers,
44 the TRANSFER_DELAY may be changed to achieve a shorter TRANSFER_DELAY value to allow for a shorter time if
45 the end to end delay in the AVB network can allow it.

46
47 The DEFAULT_TRANSFER_DELAY value is 2,000,000 nanoseconds (2 milliseconds)

48 49 50 51 **6.9.5 61883-7 timing and synchronization**

52
53 Replace IEC 61883-7 section 5.1.3 with:

54
55 The source packet header field is a one quadlet field (4 bytes) that represent an 802.1AS based time stamp.

The time stamp is used by 61883-7 capable AVBTP listeners for reconstructing a correct timing of the transport stream packets at their output. The time stamp indicates the intended delivery time of the first bit/byte of the transport stream packets from the receiver output to the T-STD (Transport Stream Target Decoder). The time stamp represents the least significant 32 bit binary time of the IEEE 802.1AS based clock at the moment the first bit/byte of the transport stream packet arrives from the application, plus an offset which is equal to the overall delay of the transport stream packet between the moment of arriving (of the first bit) and the moment the transport stream packet (first bit) is delivered by the receiver to the application.

The default value of this offset shall be 2,000,000 nanoseconds (2 milliseconds).

6.9.6 61883-8 timing and synchronization

<<Editor's note: TBD>>

1
2
3
4
5
6
7
8
9
10
11
12
13
14
15
16
17
18
19
20
21
22
23
24
25
26
27
28
29
30
31
32
33
34
35
36
37
38
39
40
41
42
43
44
45
46
47
48
49
50
51
52
53
54
55
56

1
2
3
4
5
6
7
8
9
10
11
12
13
14
15
16
17
18
19
20
21
22
23
24
25
26
27
28
29
30
31
32
33
34
35
36
37
38
39
40
41
42
43
44
45
46
47
48
49
50
51
52
53
54
55
56

6.10 Service Interface

<<Editor's note: TBD>>

7. Proprietary/Experimental subtype AVBTP protocol

<<Editor's note: introductory text TBD.>>

7.1 Overview

<<Editor's note: overview text TBD>>

7.2 Proprietary/Experimental subtype stream data format

<<Editor's note: section text TBD>>

Figure 7.1 -- Proprietary/Experimental stream data format

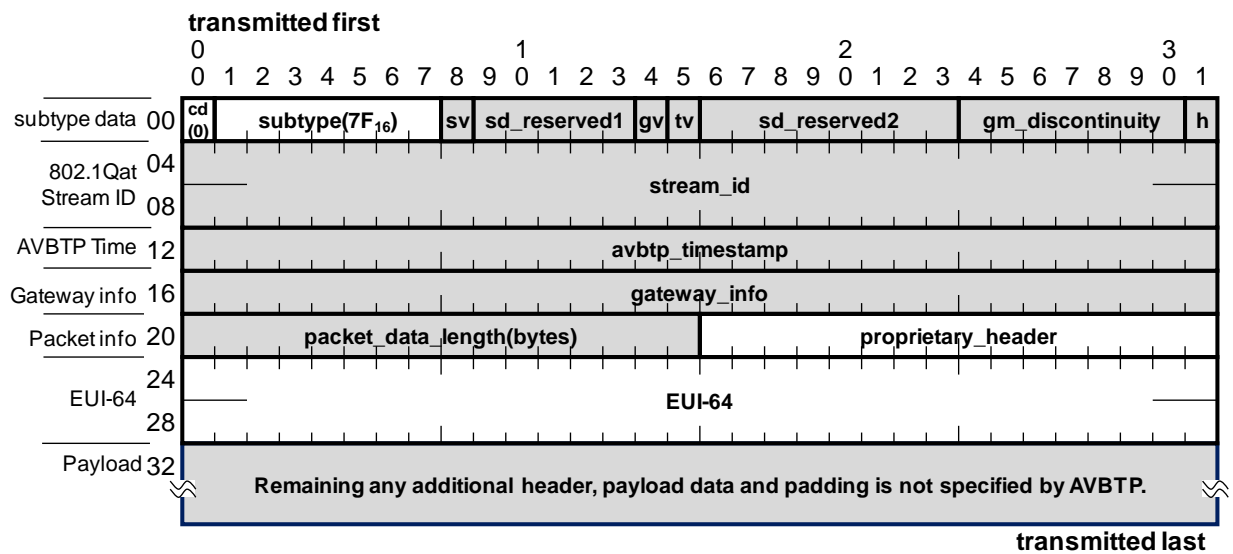

Proprietary/Experimental subtype control format

For subtype 7F₁₆ AVBTP control frames the subtype_data1 field is called the escape_type field and has the following values:

- a) A value of zero (0) in the subtype_data field is required for use by proprietary/experimental as this field
- b) Values of 1 through 255 are reserved for future use by this standard.

Figure 7.2—Proprietary/Experimental control escape subtype format

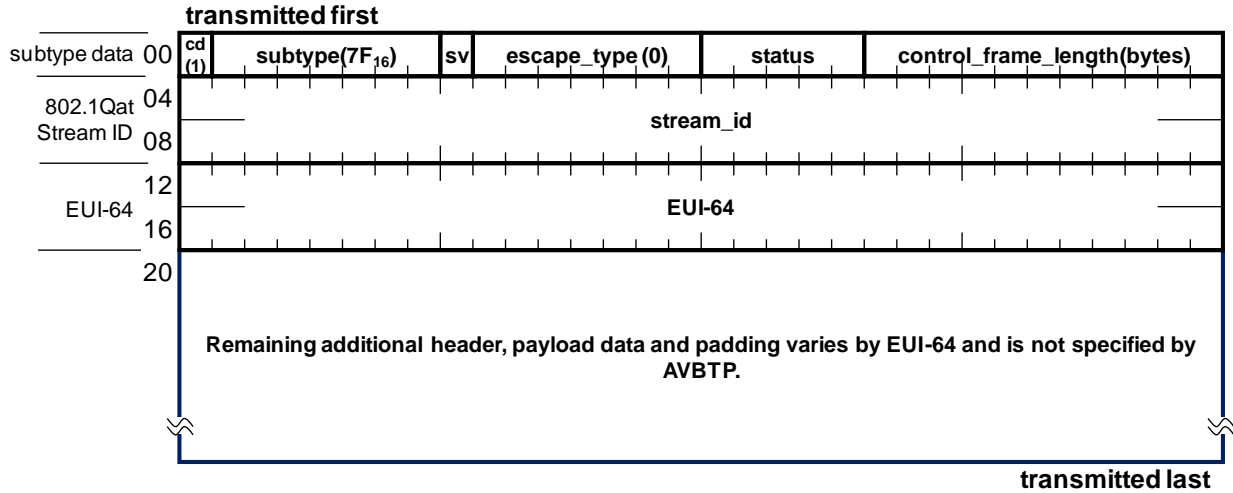

<<Editor’s note: need to add “as required” padding to ensure that the last quadlet is filled if the length does not fill the last quadlet in the frame>>

If the subtype is 7F₁₆ and the subtype_data field is 0, then following the subtype_data field shall be a unique EUI-64 field that identifies the proprietary/experimental protocol.

All data after the EUI-64 is available for use by the proprietary/experimental protocol and is beyond the scope of this specification.

Annexes

Annex A (informative) Bibliography

- [B1] IEEE 100, The Authoritative Dictionary of IEEE Standards Terms, Seventh Edition.
- [B2] IEEE EUI-64, IEEE EUI-48, and IEEE MAC-48 assigned numbers may be obtained from the IEEE Registration Authority, <http://standards.ieee.org/regauth/>. Tutorials on these assigned numbers may be found on this web site.
- [B3] [Digital Transmission Content Protection Specification Volume 1 \(Informational Version\)](#)
- [B4] [DTCP Volume 1 Supplement D DTCP use of IEEE1394 Similar Transports \(Informational Version\)](#)

1
2
3
4
5
6
7
8
9
10
11
12
13
14
15
16
17
18
19
20
21
22
23
24
25
26
27
28
29
30
31
32
33
34
35
36
37
38
39
40
41
42
43
44
45
46
47
48
49
50
51
52
53
54
55
56

THIS PAGE LEFT INTENTIONALLY BLANK

<<Editor's note: This is because the template automatically forces Annexes to start on an odd numbered page>>

1
2
3
4
5
6
7
8
9
10
11
12
13
14
15
16
17
18
19
20
21
22
23
24
25
26
27
28
29
30
31
32
33
34
35
36
37
38
39
40
41
42
43
44
45
46
47
48
49
50
51
52
53
54
55
56

B.3.2 Stream join

<<Editor's note: TBD>>

B.3.3 Data transfer

<<Editor's note: TBD>>

B.3.4 Stream leave

<<Editor's note: TBD>>

B.3.5 IWU data adaptation

<<Editor's note: TBD>>

B.3.6 General

<<Editor's note: TBD>>

B.3.7 Encapsulation

IEEE 1394 to AVBTP interworking units shall use the same format of the AVBTP IIDC/61883 as specified in clause 6 above.

IIDC/61883 [stream data](#) frames shall use the **gateway_info** field as specified in 5.6.8 above. This section defines how that field is formatted for IEEE 1394 to AVBTP interworking units.

For IEEE 1394 to AVBTP interworking units the gateway_info is formatted into the following fields:

- a) **source_seconds**: most significant 7 bits of the quadlet
- b) **source_cycle**: 13 bits with a value range of 0-7999 decimal indicating the source 1394 bus cycle of the frame
- c) **source_cycle_offset**: 12 bits with a value range of 0-3071 indicating the source 1394 bus cycle offset of the frame

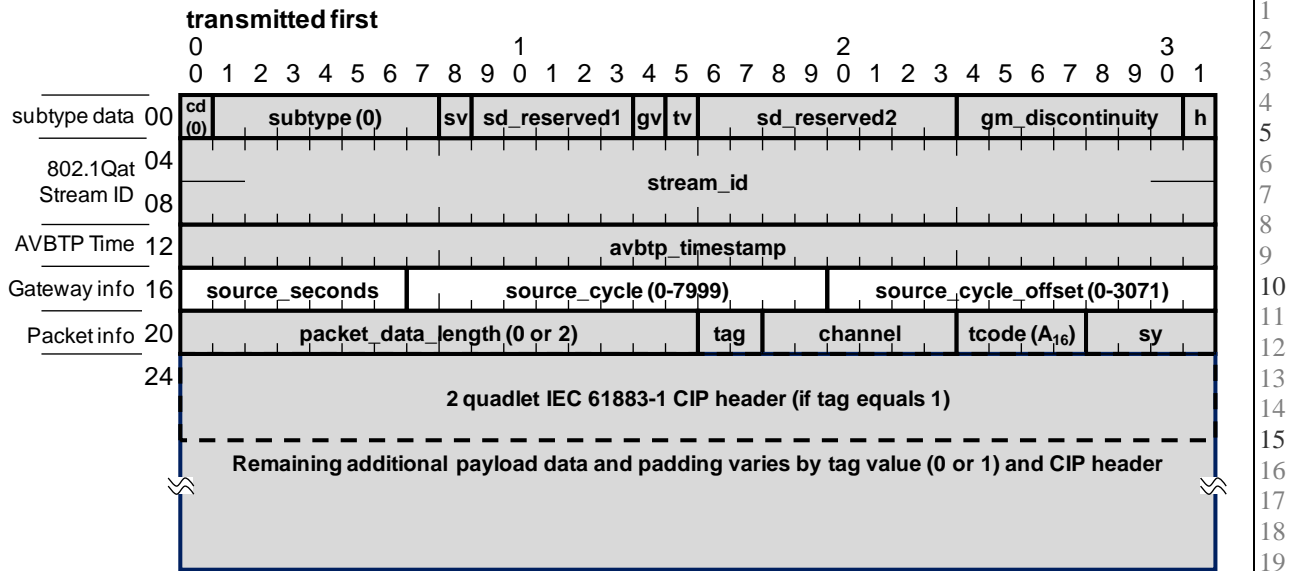

B.3.8 Stream Sequencing, Fragmentation and Reassembly procedures

CIP packets on a 1394 network may be larger than can be accommodated on the AVBTP network which has a maximum AVBTP frame size (header plus payload) of 1492 bytes.

If a 1394 to Ethernet AVBTP gateway receives a CIP packet that will not fit on the AVBTP network, then the gateway shall break up the large CIP packet into multiple smaller CIP packets prior to sending on the AVBTP network.

If an Ethernet AVBTP to IEEE 1394 gateway receives multiple packets for a given cycle and that 1394 network can support large CIP packets, then the 1394 gateway shall reassemble the smaller AVBTP based CIP packets into larger IEEE 1394 based CIP packets as necessary.

B.4 Timing and synchronization

<<Editor's note: TBD. This section is intended to list any specific requirements of gateways to map timing and synchronization field (e.g. mapping of SYT fields to and from AVBTP timestamps). Below are some notes that still appear useful from previous work we've done>>

1394 to 1722 conversion:

- a) - Convert SYT field to AVBTP presentation time
- b) Leave SYT field intact – AVB ignores it
- c) Exchange cross-timestamp packets with other 1394/AVB Gateways
- d) Could strip the 32-bit SPH to save a quadlet
 - Not really worth while
 - Would introduce jitter on 1394-to-AVB-to-1394
 - AVB Listener ignores SYT field

1722 to 1394 conversion:

- a) If SID=63 (AVB Talker)
 - Convert AVB Presentation Time to SYT field
 - Possible problems with 2ms SYT field on Part 2, 3, 5 & 6
- b) Exchange cross-timestamp packets with other 1394/AVB Gateways
- c) Possibly recreate SPH if 1394-to-AVB gateway stripped it when putting 1394 packet onto the AVB network
 - If SID \neq 63
 - And SPH = 1 (MPEG traffic, IEC 61883-4 and 61883-7)
- d) Larger range of AVB Presentation Time Offsets could require buffering in gateway

B.4.1 General

<<Editor's note: TBD>>

B.4.2 Timing adaptations/control

<<Editor's note: TBD>>

1
2
3
4
5
6
7
8
9
10
11
12
13
14
15
16
17
18
19
20
21
22
23
24
25
26
27
28
29
30
31
32
33
34
35
36
37
38
39
40
41
42
43
44
45
46
47
48
49
50
51
52
53
54
55
56

1
2
3
4
5
6
7
8
9
10
11
12
13
14
15
16
17
18
19
20
21
22
23
24
25
26
27
28
29
30
31
32
33
34
35
36
37
38
39
40
41
42
43
44
45
46
47
48
49
50
51
52
53
54
55
56

B.4.3 Synchronization

<<Editor’s note: TBD>>

B.4.4 Queuing/Scheduling Mechanisms

<<Editor’s note: TBD>>

THIS PAGE LEFT INTENTIONALLY BLANK

<<Editor's note: This is because the template automatically forces Annexes to start on an odd numbered page>>

1
2
3
4
5
6
7
8
9
10
11
12
13
14
15
16
17
18
19
20
21
22
23
24
25
26
27
28
29
30
31
32
33
34
35
36
37
38
39
40
41
42
43
44
45
46
47
48
49
50
51
52
53
54
55
56

Annex C(normative) MAC Address Acquisition Protocol (MAAP)

C.1 Overview

<<Editor's note: I have significantly changed this section based on verbal feedback from AVBTP and AVB meetings, so the intent is not to have this section perfect, but hopefully with enough detail to start the conversation on the changes that I was OK'd to take a first cut at.

In general, more and more this protocol is being discussed as a possible method to allocate not just Multicast addresses for AVBTP, but also for other 802.1 uses where multiple unique multicast and unicast addresses (such as VMware, applications that need guaranteed unique user assigned source MAC addresses, IEEE 1733, etc.). Also I have been tasked to do on this first cut:

- Make it so we can have shared Multicast MAC addresses in the future
- i) I have not put in any text about this yet, but my thought is to use the new flags field and create a shared address indicator where the application can request a Multicast MAC address range that either can or cannot be shared. Comments on this would be appreciated
- ii) <<F2F notes: Not our job. That should be done at another layer. Want to keep the layer as thin as possible.>>
 - Allow the protocol to allocate both Multicast and Unicast addresses
 - Allow the protocol to accommodate a future MAC address allocation server (similar to DHCP for IPv4) where you are told to use a specified address as given by a server rather than a random selection (this is also done to speed up the process if a server is available)
- iii) With that, I've added ASSIGN and UNASSIGN messages so that a server can say "I know you asked for range A, but I want/need you to use range B instead"

Another thing I've done is gone back and read Dr. Stuart Cheshire's Zeroconf book in that I wasn't happy with the first draft where you'd have to wait for 10 seconds to get a MAC address. Based on reading Zeroconf's methods for both IPv4 and DNS name assignment, I've added an announce phase (used by IPv4 link local assignment) and also used shorter timeouts (used by name assignment).

All comments and questions are welcome.>>.

<<Phone and F2F meeting notes:

Phone notes:

gm_info (fixed source slides)

discuss multicast address

Change to optional on tag. Recommended.

receive shall process accept both, recommended on transmit

8 bits lsb

lease time

>>

Multicast MAC addresses will be required by AVBTP for the transmission of media stream from one talker to multiple listeners. As AVBTP runs directly on a layer 2 transport, there is no existing protocol to dynamically allocate multicast MAC addresses for AVBTP.

A reserved block of Multicast MAC addresses has been reserved for the use of AVBTP these are from xx-xx-xx-xx-xx-xx through yy-yy-yy-yy-yy-yy. <<Editor's note, this range will be filled in once we have the range allocated to us from the IEEE>>

The MAC address Acquisition Protocol (MAAP) specifies a mechanism to dynamically allocate Multicast and Unicast MAC addresses in a specified address range. The base protocol uses a request, announce, defend and release mechanism and also has been designed to allow for future enhancements of supporting a MAC address assignment server via the assign and un-assign mechanisms.

In the case of AVBTP using MAAP, any application that uses addresses from the AVBTP multicast address range must make use of the AVBTP Multicast Acquisition Protocol to request and defend those addresses.

To obtain a set of addresses, an application randomly selects a multicast address from the desired range and multicasts probe packets containing the desired address range. The application then listens for a defend response or assign command. A defend response indicates that the address is in use. If no responses are received the multicast address is then assigned for use by the application. If any response is received indicating the address is already in use, then the MAAP layer randomly selects a new address range and begins sending probe packets containing the new address range. The process is repeated until an address range is successfully obtained at which point the MAAP layer informs the application of the resulting address range.

Once the MAAP layer has obtained an address it is required to remember and defend the address until it is until it is released by the application. Defending an address consists of listening for probes to use the address and responding to the probes signifying that the address is already in use.

MAC addresses can be allocated individually or as a consecutive range. A MAAP entity that is already acquired any address in a probed range must respond to the probes to defend its address.

C.2 Protocol Message Format

All MAAP frames can be transmitted with or without an 802.1Q tag in the frame. It is recommended that MAAP frames be transmitted using 802.1Q tagging. If the frame is tagged, then it shall be transmitted using 802.1Q field with a fixed Priority value of 6 and a VLAN ID of zero(0). For 802.3 and example is shown in the figure below.

Figure C.1 – 802.3 MAAP frame format

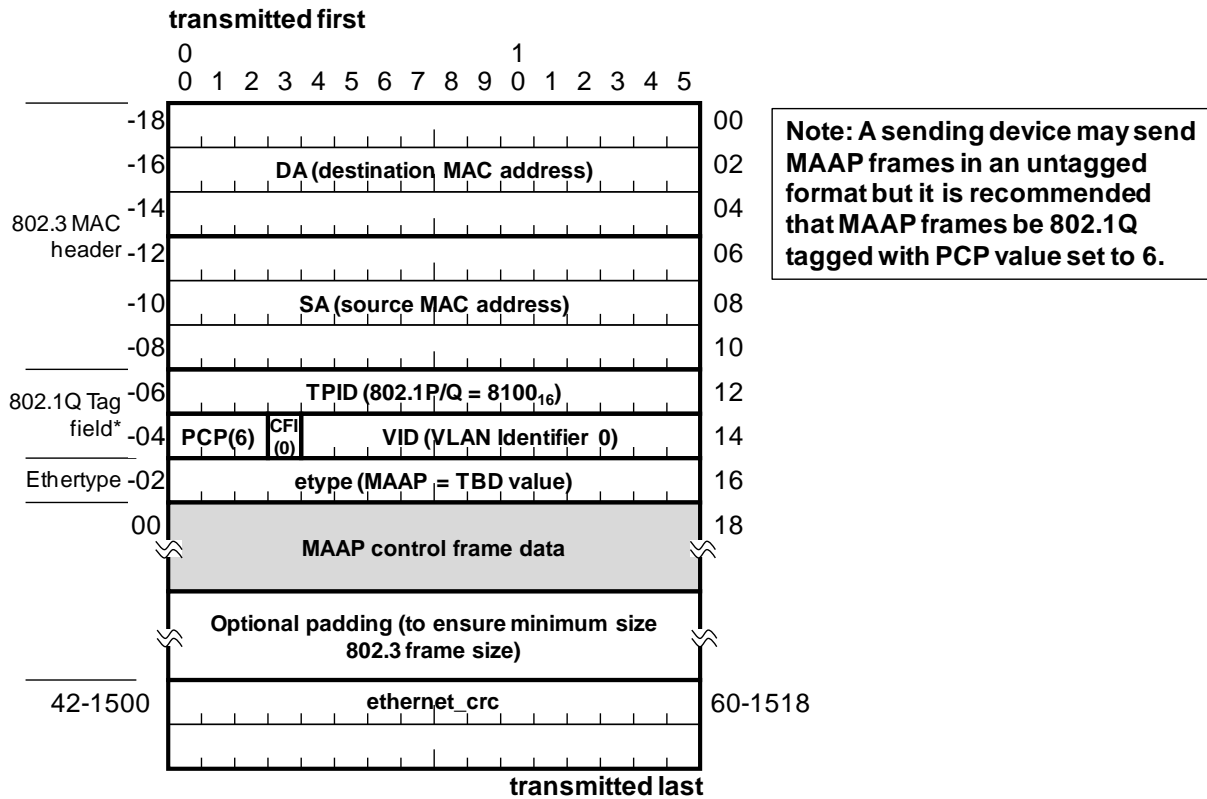

The MAAP control frame data consists of the following fields in the following order:

- a) **version_and_flags:** field: 8 bit byte with the following subfields defined:
 - **ver** (version) most significant 4 bits of this byte
 - **flags:** least significant 4 bits of this byte
- b) **message_type:** 1 byte
- c) **requestor_address:** 6 bytes
- d) **requested_start_address:** 6 bytes
- e) **requested_count:** 2 bytes
- f) **start_address:** 6 bytes
- g) **count:** 2 bytes
- h) **renew_timeout:** 2 bytes

A diagram of the MAAP frame format is shown in the following figure

Figure C.2 – 802.3 MAAP frame format

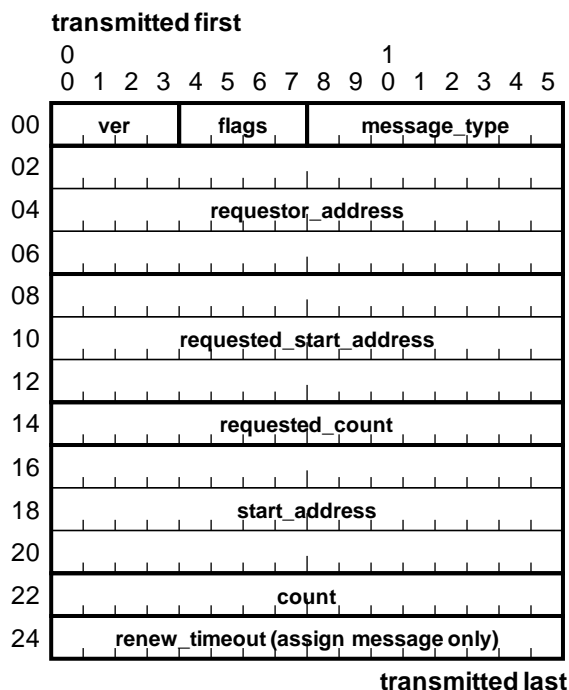

. The frame type is identified in the message_type field as follows:

Table C.1—MAC address Acquisition protocol message types

Value (decimal)	FUNCTION	Meaning
0	--	Reserved
1	MAAP_PROBE	Probe MAC address(es) frame
2	MAAP_DEFEND	Defend address(es) response frame
3	MAAP_ANNOUNCE	Announce MAC address(es) acquired frame
4	MAAP_RELEASE	Release MAC acquired address(es)
5	MAAP_ASSIGN	Assign MAC address(es) command
6	MAAP_UNASSIGN	Unassign MAC address(es) command

All MAAP frames are sent with a multicast destination MAC address set to the reserved MAAP protocol Multicast address of ZZ-ZZ-ZZ-ZZ-ZZ-ZZ. <<Editor’s note, this reserved Multicast address shall be set in a future revision of this document per IEEE rules and procedures. Current suggestion is that it is in the same OUI and address range of the Multicast Registration Protocol (MRP)>>

The Source MAC Address shall be set to the MAC address of the sender.

If the MAAP frame is 802.1Q tagged then:

The first Ethertype field shall be set to the 802.1Q Ethertype of 81-00₁₆.

The Priority Control Point (PCP) field shall be set to 6.

The Canonical Format Indicator shall be set to zero(0).

The VLAN Identifier shall be set to zero(0).

1
2 The main Ethertype field shall be the MAAP reserved Ethertype of nn-nn₁₆. <<Editor's note: This Ethertype will be
3 allocated in a future version of this specification per normal IEEE procedures>>

4
5 In a Probe message, the requested_start_address and requested_count fields shall be set to the start MAC addresses of the
6 requested range and the total number of MAC addresses requested.

7
8 The requested_start_address and requested_count represent an inclusive request for all MAC addresses between a range
9 of addresses.

10
11 <<Editor's note: I was requested at the last face to face meeting to "use the text from MMRP" to describe how
12 MAC addresses are to be documented. In looking at the current spec and its corrigendum, I did not see which text
13 to use as what I saw in the spec seemed to not describe the value and range, but instead "punted" on the subject.
14 Please advise exactly which text I should use and if it needs to be modified to meet the requirements of this
15 specification.>>

16
17 In a Response message, the Start Address and count fields shall be set to values of the start and count value of the range
18 of addresses that conflict with the requested range

21 C.3 Requesting an address range

22
23
24 An application allocates an address by requesting the MAAP entity to acquire a specified number of Multicast or Unicast
25 addresses.

26
27 If the application has previously obtained an address range and has access to persistent storage, the application should
28 have recorded the previous address range and should attempt to reuse the saved address range.

29
30 If no previous addresses were previously allocated then the MAAP entity randomly selects an address range based on the
31 number of addresses requested by the application to acquire and a range of addresses specified by the application (for
32 example, the AVBTP reserved multicast address range) . The MAAP entity selects a subset of that range based on the
33 count of addresses requested and where the requested start address is selected using a pseudo-random number generator
34 with a uniform distribution across the reserved range xx-xx-xx-xx-xx-xx through yy-yy-yy-yy-yy-yy.

35
36 The pseudo-random number generation algorithm must be chosen so that different hosts do not generate the same
37 sequence of numbers for subsequent Probe frames. The pseudo-random number generator should be seeded using the
38 least significant bytes of IEEE 802 MAC address of the requestor.

39
40 Once the address is selected the MAAP entity will start the address acquisition process. It starts by:

- 41 – Setting the maap_probe_counter to MAAP_PROBE_RETRANSMITS.
- 42 – Formatting a new probe frame with:
 - 43 • requestor_start_address field set to the Unicast MAC address associated with the MAAP entity
 - 44 • requested_start_address field set to the start of the address range requested
 - 45 • requested_count field set to the number of contiguous MAC addresses requested
 - 46 • start_address field set to 00:00:00:00:00:00
 - 47 • count field set to zero
- 48 – Sending the frame to the network
- 49 – Decrementing the maap_probe_counter by 1
- 50 – Starting the maap_probe_timer setting it to a random value selected uniformly in the range between
51 MAAP_PROBE_INTERVAL_BASE to MAAP_PROBE_INTERVAL_BASE plus
52 MAAP_PROBE_INTERVAL_VARIATION milliseconds,

53
54 If a defend response or announce indication frame is received that contains a conflicting address range as reported in the
55 start_address and count of that frame, then the MAAP entity shall randomly select a new set of addresses, and set the
56 maap_probe_counter to MAAP_PROBE_RETRANSMITS..

If an assign message is received where the requestor_address, requested_start_address and requested_count match the sent probe message, then the MAAP entity will start the announce process and inform the application of the assigned MAC address range from the start_address and count fields of the incoming message.

If a maap_probe_timer expires, then the MAAP entity will decrement the maap_probe_counter.

- If the maap_probe_counter is equal to zero, then the MAAP entity will inform the application that the Address range has been acquired and the MAAP entity will start the announce process.
- If the maap_probe_counter is greater than zero, then the MAAP entity will retransmit the current address range, decrement the maap_probe_counter by one and restart the maap_probe_timer to a new random value selected from uniformly in the range between MAAP_PROBE_INTERVAL_BASE to MAAP_PROBE_INTERVAL_BASE plus MAAP_PROBE_INTERVAL_VARIATION milliseconds,

C.4 Announcing an acquired MAC Address Range

Once an address range is acquired, the local MAAP entity shall announce to the network by sending announce messages to the network. It does this by:

- Setting the maap_announce_counter to MAAP_ANNOUNCE_RETRANSMITS.
- Formatting a new announce frame with:
 - requestor_start_address field set to Unicast MAC address associated with the MAAP entity
 - requested_start_address field set to the start of the address range acquired
 - requested_count field set to the number of addresses acquired
 - start_address field set to the start of the address range acquired
 - count field set to the number of addresses acquired
- Sending the frame to the network
- Decrementing the maap_announce_counter by 1
- Starting the maap_probe_timer setting it to a random value selected uniformly in the range between MAAP_ANNOUNCE_INTERVAL_BASE to MAAP_ANNOUNCE_INTERVAL_BASE plus MAAP_ANNOUNCE_INTERVAL_VARIATION milliseconds,

<<Editor's note: need more text here about how announces repeat until count is zero, etc. and have similar text or refer to C.5 on defending and address during the announcement phase. >>

C.5 Defending a MAC Address Range

Once the MAAP entity has acquired a set of addresses it must also defend those addresses.

If the MAAP entity receives a Probe that conflicts with any of its acquired addresses it shall send a Defend response frame back to the source of the Probe. The Response frame shall contain copies of the requestor_address, requested_start_address and requested_count from the received Probe frame. It also then reports start and count of the conflicting address range in the start_address and count fields of the defend response frame. In the case that the application has obtained multiple MAC address ranges that conflict with the request, then any one of the address ranges that conflict shall be sent in the response. If another Request frame is received that conflicts with the address range not sent in the response, then a response frame shall be sent back to the source containing this address range.

The MAAP entity may send multiple Response packets to a received Probe if the application has multiple address ranges that conflict with the address range specified in the probe.

If the MAAP entity receives an Announce message that conflicts with any of its assigned MAC addresses, then another MAAP entity has a conflicting address range that it has acquired (possibly due to message loss, merging networks, etc.). In that case the receiving may send one and only one Defend message for that address range. If a subsequent announce

1 message is sent from that remote MAAP entity, then the other side will not yield, so the local MAAP entity shall
2 relinquish that MAC address range. shall send a Defend response frame back to the source of the Probe and informing the
3 application of the address range being relinquished.
4
5
6
7
8
9
10
11
12
13
14
15
16
17
18
19
20
21
22
23
24
25
26
27
28
29
30
31
32
33
34
35
36
37
38
39
40
41
42
43
44
45
46
47
48
49
50
51
52
53
54
55
56

Annex Z(informative) COMMENTARY

This is a temporary Annex intended to record issues/resolutions thereof as the project proceeds. It will be removed prior to Sponsor ballot, and should be ignored for the purposes of TG/WG ballot.

Z.1 Unicast Destination MAC address support for stream data frames?

Will we allow unicast MAC addresses now that we have a stream ID field? Previous versions said that we would use only multicast MAC addresses for stream data frames and that the multicast MAC address would serve as the Stream identifier. Now that we have a 64 bit stream ID in each frame, do we now also allow unicast MAC addresses?

<<Editor's note: Consensus appears to be that AVBTP will not specify this and instead will "point to" 802.1Qat for all management and specification of Stream IDs and their associated MAC addresses. [As of today, 802.1Qat does support both Unicast and Multicast MAC destination addresses.](#)>>

Z.2 Need mechanism for getting PCP value for [Class A](#) and [Class B](#) streams

Group opinion from 2007-09-23 Santa Clara meeting: We should hopefully have some mechanism to make this more plug and play to have some mechanism to automatically have AVB bridges inform AVBTP end stations on what the current value of Priority Code Point (PCP) is to be used for [class A](#) and [class B](#) streaming traffic if it is changed from the default.

<< Editor's update [2008-06-15: As of today, there](#) .>>

Z.3 Does AV/C protocol need its own subtype?

Would it be more appropriate to make AV/C the standard control for 61883 and use cd of 1 and subtype of 0? Can or should AV/C be used for anything besides 61883/IIDC encapsulation??

<< Editor's note: Closed. [AV/C will no longer be carried over the proposed CTP protocol which has been deleted from this standard. Instead, applications needing AV/C shall use AV/C over UDP/IP and will require that AVBTP end stations that run AV/C protocol also require to have a UDP/IP stack and use the protocol being developed by the 1394 Trade Association](#)>>

Z.4 Need to define more details on format and function of AVBTP source Timestamp and relationship to use of the 61883 SYT field

- Current consensus high level definition is “Nominal launch time (launch to the network)”.
- For fragments, needs to be the same value for each fragment. 61883 type packets will want to be launched in 125us intervals (8 kHz clock)
- AVBTP will also need to deal with time changes in 802.1AS.
- Alternate proposal is that it is not tied to an 8kHz clock and is instead tied to the media clock and can be used as presentation time.
- Format of field is TBD (based on decision from 802.1AS)
- Full resolution target at ~1 second.
- Discussions to date have been where this timestamp indicates the “desired transmit time” for egress frames (i.e. when the frame is scheduled to be passed to 802.1Qav shaping for subsequent egress transmission).
- Further discussions will hopefully clarify the use of this field as we get further in our work on Timing and Synchronization details.

<<Editor’s note: We have made good progress on this based on the work done by Craig Gunther (see current draft sections for changes in timing and synchronization for common, 61883 and Annex B. Current consensus (to my understanding) is:

- we will not use the CIP header SYT field for the AVBTP end stations, we will use the AVBTP timestamp field. Only 1394 to 1722 gateways will need to deal with time translations/management.
- we will keep the avbtp_timestamp field at 32 bits
- we will use nanoseconds since epoch giving a resolution of around 4 seconds.
- avbtp_timestamp will be used for presentation time similar to the way that presentation time is used in IEC 61883.
- we will default to 2 milliseconds to add to sample data ingress time to create presentation time to put into the frame.
- for 61883 type traffic with SPH=0 we will use the SYT_INTERVAL mechanism (DBC used to calculate which sample frame the timestamp is related to), but use the avbtp_timestamp field instead of the SYT field.

>>

<<Editor’s update 2006-06-15: We have no agreed that when it comes to 61883-4 and 61883-7 support (MPEG Transport Stream (TS) packets support, we will follow the same convention as is supported in 1394 networks. This convention is that all Transport Stream packets have a one quadlet (four byte) source packet header with a valid timestamp. In the case of 1394, this was based on seconds, cycle and cycle offset. For 61883-4 and 61883-7 over AVBTP, we will use the same source packet header quadlet, but use 802.1AS based presentation time (32 bits of nanoseconds) instead of 1394 based cycle time.

Z.5 Need to define how 802.1Qat stream IDs are used by AVBTP

- Need to define relationship of stream IDs with source and destination MAC addresses.
- Need to have a standard Stream ID value that indicates that stream ID contains no data (perhaps all zeros or all ones?) so we can have control frames that either relate to a single stream or to a protocol options for a protocol (subtype). I would assume all zeros would be better as all ones in addresses are usually used for Broadcast.
- Need to define how stream ID management ties into AVBTP session management.

<<Editor's update 2008-06-15: We have added the stream valid bit in all AVBTP frames, so the "no data" issue above is no longer an issue. As far as destination MAC addresses goes, the assumption is that AVBTP end stations will get all they need from 802.1Qat as far as correlating between MAC addresses and stream IDs with the addition that AVBTP has now also defined in Annex C a mechanism to use a Zeroconf like mechanism to request one or more unique MAC addresses using a query and defend mechanism.>>

Z.6 Need to define what happens if presentation time has passed and/or is out of range.

<<Editor's note: cut and paste from Craig Gunther's contribution>>

1. What about playing samples if presentation time has already passed?
 - What if it only happens once?
 - What if it consistently happens?
 - Consumer only?
 - Visual indication if samples are discarded?
2. What about presentation time that is so far in the future that the node can't buffer it?

<<Editor's update 2008-06-15: This has not been discussed for a while. We should probably discuss this at the Fremont face to face meeting on June 19, 2008>>

<<END OF CURRENT DRAFT DOCUMENT>>

1
2
3
4
5
6
7
8
9
10
11
12
13
14
15
16
17
18
19
20
21
22
23
24
25
26
27
28
29
30
31
32
33
34
35
36
37
38
39
40
41
42
43
44
45
46
47
48
49
50
51
52
53
54
55
56