

Minutes of the IEEE P802.11 and 4L Working Groups

Intermediate Meeting
Oshawa, Ontario, Canada
September 10-14, 1990

IEEE P802.4L Task Group session

Monday, September 10, 1990

Eighteen (18) people were in attendance, Vic Hayes chairman IEEE P802.4L and acting chairman IEEE P802.11 being in the chair.

1. Opening

1.1 Introduction was deferred till Tuesday

1.2 Attendance list. Attendance at the first meeting qualifies for membership. In as much as the first meeting of 802.11 is an intermediate meeting, attendance at either the Oshawa meeting or the La Jolla plenary meeting qualifies for membership. Continued or new membership requires attendance at 2 plenary meetings, or one working group and one plenary meeting, per 4 plenary meetings. Attendance at a meeting is defined as at least 75% participation as determined from the attendance list.

1.3 Note taker. Michael A. Masleid volunteers as note taker.

How do we plan to carry through the documentation of the 802.4L working group into 802.11? Can we create a document containing all of the existing papers? Refer to documentation structure (5.7). A way will be found for new members to obtain old documents.

Can the work of 802.4L be gracefully terminated? Masleid pointed out that '4L has been perceived as exclusively an industrial application, and so is of little interest to manufacturers. He questions whether the needs identified in '4L will be represented by .11. If the meaning or wording of "shop floor" can be extended to include the factory than this is satisfactory.

After some discussion, a motion from Jonathon Cheah: "**That 802.11 will not preclude the support of industrial environments which are characterized by large delay spread, large area and high magnitude and high variety interference,**" Second by Jim Neeley. Was accepted 13 - 0 - 2.

2. Termination of IEEE P802.4L

2.1 Minutes of the Denver meeting. The minutes of the July meeting of the IEEE P802.4L Task Group were reviewed. After identification of typographical errors they were **approved without objection.** An updated version will be made available to 802.4.

2.2 Any other business. Having no other business it was **agreed** without objection

that the 802.4L task force be terminated.

IEEE P802.11 session

3. Registration of contributions: Documents O/1 through O/7 were identified; refer to the temporary document list in appendix 2.

4. Adoption of Agenda (doc IEEE P802.11/90-9): A discussion of objectives and milestones ensued, further discussion was referred to (6.1) Revision of the PAR.

Under item 7a an agenda item: "Further input on FCC GEN Docket 90 - 314" was added.

The **agenda was accepted** as modified.

The meeting adjourned at 4:43.

Tuesday, September 11, 1990

The meeting of 802.11 was called to order 9/11/90, 8:36 A.M. Twenty six (26) people were in attendance, Vic Hayes acting chairman IEEE P802.11 being in the chair.

5. Start of Working Group IEEE P802.11.

5.1 Voting rights were reviewed.

5.2 Election of the chairman of the Working Group: Vic indicated that his company was prepared to support him as Chairman. Chandos Rypinski assumed temporary chairmanship and accepted nominations for the chair. Paul Odlyzko nominated **Vic Hayes**, seconded by Jonathan Cheah. This was **accepted without objection**.

5.3 Election of the Vice-chair. **Jim Neeley** volunteered for **Vice Chair**. **Accepted** by acclamation.

5.4 Election of the Secretary. **Michael Masleid** volunteered for **Secretary**. **Accepted** by acclamation.

5.5 Election of editors. **Jonathon Cheah, Chandos Rypinski, and Michael Masleid** volunteered as editors.

5.6 Operating Procedures. Document O/5, section on Working Group rules of the 802 operating procedures was reviewed. It was agreed to work according to these rules, and these rules are captured in the archive of 802.11.

We will follow parliamentary procedures when necessary to insure progress.

Normally a vote is carried if there is 75% approval among those voting Approve and Do Not Approve. It was agreed that if only a simple majority is achieved then the issue should be held as an open issue. It was also agreed that if at least 75% approval is achieved, but in the opinion of the officers (chair, vice chair, secretary, editors) there is significant disagreement, (particularly one that may result in ISO no votes,) the issue will not be closed.

An interim working group meeting with less than 50% of the voting membership present, or any task group meeting, must have it's work ratified by a subsequent plenary meeting, or by an interim meeting that has a quorum.

(1.1 deferred) Introductions: The members present introduced themselves, there affiliations, and interests.

5.6 Operating Procedures (continuation). The responsibilities of the Chairman where reviewed (4.4.3) of 802 operating rules, document O/5. In particular note that minutes are to contain all motions, mover, seconder, and voting results. The minutes shall be such that one knowledgeable but not present can understand what was agreed to and why.

5.7 Documentation Structure. Vic Hayes introduced document O/2 as a proposal for a loose leaf archive. This archive contains Project Authorization, Procedures, Questions, Positions and answers, Definitions, and Supporting documents. The list of Questions is expanded and includes Architecture, MAC, PHY, Distribution system, Media, Network and Station Management, Regulation, and Miscellaneous

In general, new and revised pages will be distributed to members to update their archives. New members can order the current archive from the Chairman until other arrangements can be made.

The committee agreed to **adopt this archiving method.**

5.8 Mailing lists types. The Working Group will maintain two types of mailing lists to reduce distribution of unwanted materials.

It was agreed that members and observers who have attended at least one working group or task group meeting in the last four meetings, will receive the full set of documentation.

It was agreed that executive committee members, liaison members, and interested parties will receive the meeting minutes (without annexes), meeting announces and draft standards.

A long discussion on the concern - whether or not a participant can be protected from exposure when his opinion as an individual member may inadvertently be interpreted as a corporate policy or statement of direction of his company. Jonathon Cheah moves, second by Nathan Silberman, and amended to read: "Minutes contain attendance list without corporate affiliation, but with a phone number supplied by an attender." failed by 9 - 12 - 3.

We agreed that the minutes will contain attendance lists, corporate affiliations, and telephone numbers.

Vic requested to be informed of the E-mail addresses of members for fast and easy communication. Members were encouraged to obtain E-mail but Fax will be used as a back up.

The viability of access to a bulletin board was discussed. Orest Storoshchuk undertook to investigate whether or not the GM MAP bulletin board was still available. Note: Orest reported to the chairman that the bulletin board was still available, but that people needed to dial in directly in the Detroit system, which may be prohibitive for costs.

Document ordering method: Larry Vanderjagt undertook to find cost of an document copying system, so that new members can purchase the historic document set.

6. Review of charter

6.1 Revision of PAR. Scope and objectives. Review of documents for establishing 802.11 (refer to doc: IEEE P802.11/90-7).

Note: The reference to attachment 1 on page 9 is to page 7. The reference to attachment 2 on page 9 is to page 8.

Changes were made to 4.1 a) to satisfy an earlier motion. Applicable area now includes "office and shop floor, industrial environment -- rapid interconnect."

Changes were made to 4.2 a). As written it is not clear where the BER requirement is placed. It was decided that the equivalent of this should be placed at the LLC to MAC interface, leaving 802.11 freedom to find solutions that meet this required performance level without making assumptions about behavior at the MAC to PHY interface. Further changes were proposed to differentiate between a minimally compliant network and fully compliant network that meets all IEEE 802 functional requirements at the expense of complexity. This task was referred to an ad hoc group under the leadership of Michael Masleid.

- A+ Peter Cripps: we are committed to deliver packets with an equivalent BER to the wired network. We must do this to be compatible to other 802 networks
- A- For consumer products, it is not possible to assume that the environment can be modified. (Dave Bagby)

6.1 Revision of PAR, (continuation)

It is assumed that the installation guide lines will indicate what can be done to bring the remaining minimally compliant installations into full compliance. Jim Neeley suggests that the development of recommended practices belongs to a different committee, as has been done by 802.7 for broad band, and by 802.8 for fiber.

Larry and Michael gave a short presentation on the measurements done at GM, with short path and long path impulse response, time variance (corrected for measurement impairments of gain, phase, and oscillator precession), and spatial variance for 1 inch motion. These measurements were made from location U51 to Z56. This highly obstructed 100 meter path will be shown on the plant tour scheduled for September 12.

Ray Simpson moves **"That we remove the section of the micro bridge in the scope"** (section 3, page 7). Peter Cripps seconds. Carries 22 - 0 - 1.

- A+ A micro bridge will be complicated to build.
- A+ Benefits of retaining are unclear.
- A+ The micro bridge imposes the loss of the network managed object interface.
- A+ Retaining will cause significant delay in standard development.
- A+ A micro bridge can be built without having to standardize it.

Orest says we should invest in the .4 and .3 spoofers, remove the red picture, but leave the hooks needed for the spoofers.

Dave moves **"to remove the etc in point 2 of the scope and objectives document"**. Second by Buddy Cook. Carried 22 - 0 - 0.

- A+ SRT bridges are now included in 802.1 D.

Chan moves **"That 802.11 defines a pluggable MAC/PHY interface which is required if the MAC/PHY interface is exposed."** Second by Bruce. Carried 22-1-0

- A+ It is a natural partition in organizational skills.
- A+ Allows a vendor to develop a PHY layer for the OEM market.
- A+ The 802.11 PHY might be adapted to other 802 MACs.
- A+ Supports testability.
- A+ Supports possibility for a voice channel
- A+ Allows flexibility for changes in spectrum regulations or international variations in spectrum regulations.
- A+ creates a multi-vendor purchasing opportunities.

The meeting adjourned at about 5:15.

Wednesday, September 12, 1990.

Plant tour in the morning, until lunch. Meeting called to order 12:30. Twenty seven (27) people in attendance, the acting chairman and the secretary present.

6.1 Revision of PAR (continuation)

Michael Masleid reported the discussion of the ad hoc group; a full report is provided in annex 1. Larry Vanderjagt objects to points 1 2 and 3 and the note.

Larry presented the following written text:

beginquote:

The proposed standard will meet all of the 802 Functional requirements, except that the probability that a MAC Service Data Unit (MSDU) reported at the MAC service interface contains an undetected error, due to operation of the conveying MAC and Physical Layer entities, shall be less than 5×10^{-14} per octet of MSDU length and the MSDU loss rate will be less than 4×10^{-5} for MSDU length of 512 octets, in a minimally conformant network.

A minimally conformant IEEE 802.11 network will meet these requirements over a minimally conformant radio service area. IEEE 802.11 will define standard approaches to allow minimally conformant systems to be enhanced to achieve full 802 functional requirements over the radio service area.

Definitions

Minimally conformant radio service location - a physical location at which radio service is available at least 99.9% of the time on an annual basis.

Minimally conformant radio service area - physical area in which at least 99.9% of the total geography consists of minimal conformant service locations.

Endquote

Bruce Tuch moved "**that Larry's submission replace the output of the committee**". Larry Vanderjagt seconds. Carries 23 - 0 - 1.

Dave Bagdy moves "**That we accept this new text for inclusion in the PAR.**" Second Jim Neeley. Carries 23 - 0 - 1.

A discussion ensued on the time span (annual basis). The following is captured of the discussion in IBIS format:

- P Availability should be measured on an annual basis.
- A- Hard to test
- A- Year span fades are hardly time variant
- A- implies fades may be long time, not milliseconds
- A+ The seasonal variation may effect Microwave performance

- P* change to a day, installer must take into account annual variation.
- A+ daily is more testable than yearly
- A- implies fades may be long time, not milliseconds

Ray Simpson moved "**that the word annually be changed to daily in the exceptions statement**". Second by Chandos Rypinski. Carries 24 - 0 - 0.

Thursday, 13 September 1990

Twenty one (21) people present. The acting chairman and the secretary being present.

6.1 Revision of PAR (continuation)

Vic introduced document O/12 (see annex 2) which is a capture of the discussions of Tuesday and integrated with the information available in the qualifications section of document IEEE P802.11/90-7.

This text was amended by many motions. Reference to specific speeds in § 5 was criticized; the discussion is captured as follows:

A+ Discourages yet another PAR to handle higher speeds without dealing with the issue now.

P Specify up to 5 mph (pedestrian).

A+ For some of us pedestrian speed is an absolute requirement.

P Specify more than 5 mph (vehicular).

A+ vehicular traffic moves faster than 5 mph

A- creates constraints on the modulation

Ray moves, second by Masleid, to replace speed paragraph. The eventual amended text "**The standard shall support stationary stations, movable stations, and mobile stations moving at pedestrian and vehicular speeds. To be implemented with one PHY if feasible**" Carries 20 - 0 - 5

Discussion on § 6: "Because the dynamic range of wireless systems it is almost certain that the local area is limited to an order of magnitude as small as 400 - 1000 m**2 and that a distribution system is almost certainly required to extend the coverage of the overall network using exiting standards where feasible." resulted in a presentation by Jim on his view of the architecture (refer to annex 3). The inconclusive discussion is captured as follows:

P Architecture should be within the scope of the PAR

A+ it has to be for us to do the work.

different speed range stations may exist within the same coverage area

P each of these topics seems to be interrelated, can we talk about what it is that we intend to accomplish (in the scope)

Basic service area, ability to interconnect, range extension beyond the basic service area.

Issue: What is the Architecture. Who are our clients.

P minimally conformity at 5 mph, full conformant is faster.

A- there may be different techniques required (or optimal) for fixed (quasi static), up to 8 km/hour (pedestrian), and faster (vehicular) stations within networks. There is an assumption that peer to peer is a two step process, and that impacts this also.

A unit that operates in a basic service area must also be able to work when moving into an extended service area.

The PHY layer has been divided into two layers in other standards, for instance FDDI PMD's and 802.9's work. What needs to be changed for licensed vs unlicensed, if a change is needed, is within the PHY, (at the PMD).

6.1 Revision of PAR (continuation)

Single basic service area networks shall be compliant (non distribution system with or without a head end, allowing peer to peer, but not assuming peer to peer, since most communication goes to servers, or at least did once.)

Bruce moves to replace the dynamic range paragraph (§ 6) with: **"Because the range of wireless transmission / reception may be smaller than the physical coverage area desired, a distribution system designed to provide range extensibility will be addressed as part of this standard."** Don seconds. Carries 20 - 1 - 4

§ 7 proposing: "The PHY Layer for radio waves shall have a frequency band, power output and modulation scheme that makes unlicensed operation of the equipment possible. As frequency spectrum is a precious resource, selection of a completely free band seems impossible." caused a discussion captured as follows:

- A- Unlicensed operation is overly restricted
- A- Unlicensed operation makes control and regulation impossible
- A+ There are no or few cost free licensed bands available
- A+ Licensed bands could eliminate the multi-vendor environment

Dave moves replacement of this paragraph, Ray seconds and Jonathan moves amendment to: **"PHY layer suitable for use with unlicensed RF equipment will be defined with this standard. If evidence of need and sufficient interest exists other PHY layers will be considered at a later time."** After a call of the question the motion carried with 13 - 2 - 4

P unlicensed can be protected by regulation through required type acceptance.

Chan moves to replace in § 9 the sentence starting with "Therefore the initial...", and delete § 12 "Pending available of such..." by **"Currently the only available spectrum is in the ISM bands in the USA provisionally 915 MHz band in Canada and Australia. Test programs are underway in the UK and elsewhere, evaluating license free operation."**

Therefore the initial work of this committee will be for the ISM bands." Second: Ray. Carries: 13 - 1 - 5

The discussion is captured as follows:

- P Other users can put as much as 1.5 kW in this band (915 MHz), so it is a mistake to focus on this band.
- P Modulation choice is strongly influenced by the initial choice of band, and this may be the wrong choice for modulation. This choice is an accident of the FCC regulations.
- P A procedure for examination of other modulation types should be done.

Jonathon moves that the remainder of § 9 be replaced by the following text proposed by Chan: **"However, these bands are already heavily used, and it is felt that service degradation from other users will happen, increasing with time. Therefore, in order to further development of the standard, the 802.11 committee should participate in the development of changed or new regulations for short distance radio services in which all authorized users of any new frequency allocation shall be permitted to radiate only a defined maximum power density."** Ray seconds. Carries 13 - 0 - 6

- A+ System design is easier if excessive transmitter antenna gain is not allowed.
- (P Some systems may use high transmit antenna gain with limited radiated power density.
- A- But this will not provide attenuation with distance.
- A+ But it might help multipath.),
- A- Some of the technology needed has not yet been invented
- A- We may need regulatory changes before the work is done

6.1 Revision of PAR (continuation)

Chan moves to replace § 11, "The goal is to obtain worldwide... ", into: **"To further enhance the standard the 802.11 committee will undertake to document the benefits of, and make recommendations for international standardization where possible."** Second: Bruce Carries 17 - 0 - 2

Buddy moves to leave § 13, "Supported environments include:

in buildings such as offices, financial institutions, sho...etc" in the PAR. Second Ray: Carries 16 - 0 - 3

A- The implications have been covered elsewhere

A+ It is not in the PAR.

A+ This is the necessary definition of the market.

A- This does not include residents

The discussion about § 14, "Note: Cost reason may force the definition of [different] classes of PHYs for environments with benign or hostile characteristics." caused proposal of the following 2 alternatives:

Proposal 1 new: **"The definition of classes within a PHY may be necessary to support environments with benign or hostile characteristics. "**

Proposal 2 new: The definition of performance classes within a PHY may be necessary to support environments with benign of hostile characteristics.

Bruce moves to accept the second proposal. Jonathon second. Out of the discussion the following is recorded:

A- This seems to constrain us unnecessarily at the beginning.

A+ given an environment with an extended area of coverage. All must communicate with the distribution system (a high class PHY, class 3) stationary stations can be class 1, pedestrian class 2, vehicular class 3.

Definition: Classes within a PHY. Any classification within a PHY will interoperate at the lower class. Any classification will support the lower classes operation.

A- This precludes other possible solutions

Defer this: Receivers in a distribution system should operate at the highest classification needed by the stations in the service area.

Jonathan called the question, second Masleid; vote 19 - 0 - 1. So the main motion was put under vote. Carries 11 - 6 - 3

Jonathon moves that the sentence "Note: Cost reasons may force..." be struck. Second Chan. Failed 7 - 8 - 5

Jim produced a proposal to satisfy the classes and multiple PHY issue by the following:

Supported topologies will include:

- Basic Service Area (BSA) in which each station can communicate directly with every other station in the BSA, as a low cost solution.
 - * No single station failure will fail the LAN
- Extended Service Area (ESA) in which each station's transmission are received by a defined and managed Distribution System that [relays each message to the station] retransmits to every other station in the ESA.
- Stations which interoperate in both BSA and ESA may be defined if feasible.

6.1 Revision of PAR (continuation)

Jim moves to include this paragraph in the PAR, Second: Larry.

After a long debate, the motion was amended to:

The standard will include support of the following:

- Basic Service Area (BSA) in which each station can communicate directly with any other station in the BSA.
- Extended Service Area (ESA) in which each station can communicate with any other station via the defined and managed Distribution System.
- Stations which interoperate in both BSA and ESA shall be defined if feasible.

Move to call the question: Second Chan. Carries 12 - 4 - 3.

Main motion as amended was then voted on resulting in a failure 6 - 10 - 3.

Bruce moves that the just rejected proposal be accepted for the scope after removal of the word "directly", second: Jim. The chair ruled this motion out-of-order as it would reconsider a subjected already decided upon in the same session of the assembly. A long discussion on parliamentary procedures embarked. It seemed to be the rule that the assembly could accept the motion only if a motion to reconsider would have passed with a majority.

Bruce Moved to be allowed to make the above mentioned motion, second by Kiwi. Carried 12 - 4 - 2.

The discussion went on and it was considered at a certain time to table the motion. Eventually, it was decided to vote on the motion and to see what comments would be received at the next meeting. So the vote on the motion to include in the scope of the PAR:

"The standard will include support of the following:

- **Basic Service Area (BSA) in which each station can communicate with any other station in the BSA.**
- **Extended Service Area (ESA) in which each station can communicate with any other station via the defined and managed Distribution System.**
- **Stations which interoperate in both BSA and ESA shall be defined if feasible."**

carries with 10 - 7 - 4.

The next discussion was on § 15: "The Wireless MAC shall support both connectionless service as defined in the MAC Service definition at rates between 1 and 20 Mbit/s as well as a service supporting packetized voice."

Support for voice was given because the hooks can not be retrofitted, it must be done up front if we imagine the customer will want voice service. This is confirmed as possible in 802, we wish to include it.

We may need to do lower than 1 Mbit per second in the ISM bands, however, 802 is mandated to work in 1 - 20 Mbit.

Dave moved to make a resolution that: **"We adopt a resolution that says the standard will be designed so as not to preclude operation with PHYs that have data rates down to 100 kbit/s."** Second: Ray; Carries 13 - 2 - 3

- A+ There is a significant class of users served by lower data rates. (And suppliers that would like standardization)
- A+ Maybe it is hard to do 1 Mbit may have more range at slower speed.
- A+ Some environments may require lower than 1 Mbit/s to provide reliable service.
- A- Whose charter is this in, we may be in turf conflicts
Who wants lower than 1 Mbit/s other than us?
TAGs may want this turf

6.1 Revision of PAR (continuation)

- A+ Lower data rate allows consideration as possible, 19.6 or 19.8 or above is not well covered.
- A+ Leverages our work so we don't have to reinvent the wheel.

§ 17 was not criticized. The chair was given the mandate to correctly represent the standard references: IEEE 802.1 D for T and SRT bridges. A for ... F for

On § 18, The MAC design shall anticipate restriction on low-frequency pulsing of Electromagnetic fields due to biological hazards. This may require a transmitter on-off rate to be either irregular or a few hundred Hz or greater under all conditions." Chia-Chi stated that it is difficult to determine what is hazardous at this point. Health rules exist, can we just obey them? The answer was "No, they are too old" You are responsible for making the system safe. A motion to **remove second sentence carried** with 9 - 4 - 3

A motion to **amend by insertion ... pulsing of ... to below 100 Hz carried** with 14 - 0 - 4.

Having no existing standard to refer to it was decided to keep the paragraph as modified to "The MAC design shall anticipate restriction on low-frequency pulsing below 100 Hz of Electromagnetic fields due to biological hazards."

The scope of the standard was now available. discussion continued on 7. Purpose of proposed standard.

Jim moved to change § 20 to "**To provide a standard for use by regulatory bodies to control the shared use of one or more radio frequency bands.**" Don second, carries 14 - 0 - 4

The next section: 10 Target completion

Some think the schedule is optimistic. Some think it is brave, courageous, necessary. But yet it was decided to set target completion to Dec 31, 1992, not Jan 1993

The next section: 11 Proposed Coordination.

ISA SC-72 was updated into SC50. The following was added:

ANSI ASC T1 advisory group in T1E1 starting similar work on personal networking.

TIA telecommunications Industry Association TBD

SAE, the society of Automotive Engineers. TBD

ACM? (Association of Computing Machinery.) TBD

ETSI RES (European Telecommunication Standards Institute, Radio Equipment standards) TBD

Chandos will try to contact Frank Rose, FCC, US representative to Interim Working Party 8/13 on Future Public Land Mobile Telecommunication Service (FPLMTS) to discuss any relevant information to IEEE P802.11.

Mike undertook to make a draft representing the state of the PAR for review.

7. Review of the architecture for the Wireless MAC

It was decided to prepare ad-hoc material on Architectural points for presentation on Friday. The following outline was preferred:

A simple picture in half foil size

Markets of interest that the architecture addresses

Requirements that the market places on the architecture.

11. Next (plenary meeting)

The objectives for the next meeting were discussed. The following was agreed:

- Finish subjects placed on the table
- Review the PAR proposal (doc. IEEE P802.11/90-11)
- Create a list of markets that we all wish to address.
- Identify customers that are to be served and list their needs
- define the architecture concepts that will supports those needs
- Review reply comments on FCC GEN Docket 90-314

The last mailing date for documents has been set for October 10 1990. Ad-hoc contributions were discouraged, Distributed documents will be given attention first, late written documents (bring 50 copies if possible) will be given attention next and Ad Hoc contributions will be given attention last

11a. Next Intermediate meeting

Next intermediate meeting will probably be held in Gaithersburg January 7-11, 1991 to provide an opportunity for FCC engineers to attend the meeting. Host will be Jonathon, Chan will inquire whether the NIST could provide meeting accommodations.

7a. Further input on FCC

Chandos addressed the committee in the following way:

At the last meeting we worked on the draft of the FCC letter. If it is at all possible put in a letter on this docket from your own company. In any letter put your qualifications, why you have and opinion, and why it should be listened to. Give your opinion on the document. Voice communication service views data as a subset. If there is a provision for a service, the need for a data service should concurrently be considered. Details of how are not called for unless a major company. Market stuff and needs are good to mention, however, your own product and profit is not important. Improving GNP and balance of trade is important. It should be short, but can be long if you have something to say. Do say the IEEE is an appropriate forum, since it is a mix of users, suppliers, and has international scope, and a history of doing this kind of thing.

Always respond to what they ask, but if you have something interesting to say they will notice it. Deadline is October 1, 1990.

Chan will try to report what comments were submitted.

The meeting was adjourned at 5:06 adjourn for 8:30

September 14, 1990

The meeting was called to order at 8:45. The acting chairman and the secretary were present.

Michael Masleid had prepared an updated version of the PAR contents in temporary document O/14, a revision of temporary document O/12.

Jonathon moves "that temporary document O/14 be circulated to the members of 802.11 and presented to the Executive Committee before their Monday meeting in La Jolla, Ca, November 12 for review and comments to enable 802.11 to prepare a final draft for the Thursday evening Executive Committee meeting" Second: Bruce. Carries 17 - 0 - 0

Masleid moves, second by Larry that "Chairman empowered to make spelling and typographical error corrections". Carries 17 - 0 - 0

7. Architecture

Jim presented the architecture of FDDI On block diagram. (Annex 4) It was agreed that we would work along the following questions for the work in the near future:

- ?I: What should be specified in a standard satisfying PAR 802.11a?
- ?I: What is the WLAN Architecture?
- ?I: What services are required from the WLAN?
- ?I: What scenarios in topology are of interest?
- ?I: Which functions are required to support the services and topologies
- ?I: What is the best placement of the function.

The meeting then focussed on ad-hoc presentations given by Bruce Tuch, Dave Bagdy, Jim Neeley, Chandos Rypinski and Michael Masleid

15. Closure

The meeting adjourned at 11:00 am. Vic thanked all participants for their contributions. He specially thanked Orest Storoschuk for the excellent meeting facility and the support received by the staff of General Motors, in particular the Rotech Training Center.

Appendix 1 Attendance list

Mr. DAVE BAGDY	Toshiba America Information Systems Inc	714 583 3846
Mr. CHANDAN BANERJEE	,NYNEX Corporation	914 287 5543
Mr. KEN BIBA	Agilis Corporation	415 962 9400
Mr. DALE BUCHHOLZ	,Motorola Inc.	708 632 5146
Dr. JONATHON CHEAH	,HUGHES Network Systems	619 453 7007
Mr. BUDDY COOK	II-Morrow	503 581 8101 X814
Mr. PETER K. CRIPPS	Agilis Corporation	415 962 9400
Mr. ANDREW FLATLEY	,NYNEX Corporation	914 644 6137
Mr. CHRIS HALLINAN	,BICC Network Solutions Inc	508 842 7300
Mr. VICTOR HAYES	,NCR Systems Engineering B.V	+31 3402 76528
Mr. HAMID R. HEIDARY	,C-COR ELECTRONICS INC	814 238 2133
Mr. BOB HEILE	,WIN Systems	508 689 3995
Mr. VIC HSIAO	Toshiba America Information Systems Inc	714 587 6157
Mr. CHIA-CHI HUANG	,IBM Research	914 945 3286
Mr. LARRY van der JAGT	,Knowledge Implementations Inc	914 986 3492
Mr. DONALD C. JOHNSON	,NCR Corporation WHQ 5E	513 445 1452
Mr. MICHAEL MASLEID	,Inland Steel Co. MS2-465	219 399 2454
Mr. STEVE MESSENGER	,Telesystems SLW inc	416 441 9966
Mr. JAMES. NEELEY	IBM	919 543 3259
Mr. PAUL ODLYZKO	Motorola Inc.	708 632 3135
Mr. ANDRZEJ PARTYKA	,PA-Consulting	609 426 4046
Mr. CHANDOS RYPINSKI	,LACE Inc.	707 765 9627
Mr. WALTER SCHREUER	,WIN Systems	508 689 3995
Mr. NATHAN SILBERMAN	,Symbol Technologies Inc	408 446 2210
Dr. RAYMOND SIMPSON	,O'Neill Communications Inc	609 924 1095
Mr. KIWI SMIT	,NCR Systems Engineering B.V.	+31 3402 76479
Mr. WALT SONNEVILLE	,Sonnevile Associates	301 869 4460
Mr. OREST L. STOROSHCHUK	,General Motors of Canada	416 644 6994
Mr. BRUCE TUCH	,NCR Systems Engineering B.V.	+31 3402 76527

Appendix 2

Temporary Document list

Ref No	Source	Title	Destination
O/1	Hayes	Document list	
O/2	Hayes	Archive	90/
O/3	Hayes	First ad hoc Group of ASC T1	
O/4	Hayes	Update old IBIS list	archive
O/5	Hayes	802 operating rules for a WG	archive
O/6	Banerjee	Multi-Freq Radiowave measurements in the portable radio environment	referenced
O/7	Banerjee	Time Delay Spread Measurements at .85 and 1.7 GHz inside a metropolitan office building	referenced
O/8	Rypinski	Radio Propagation inside a building	90/
O/9	Rypinski	Summary of US Frequency bands	90/
O/10	Rypinski	Sharing Spectrum	
O/11	Rypinski	Background material	90/
O/12	Hayes	Draft PAR (intermediate result)	
O/13	Neeley	Architecture	
O/14	Hayes	Updated draft PAR	

Appendix 3

List of annexes

(For members only)

- 1 Minutes of ad-hoc group on Error Rates
- 2 Draft PAR (Intermediate result, O/12)
- 3 Architecture proposal (O/13)
- 4 FDDI architecture
- 5 ad-hoc presentations

Minutes of ad-hoc group on Error Rates

Tuesday, 12 September 1990, Evening

Six (6) people in attendance, Michael Masleid in the chair.

The ad hoc meeting group convened following a short break. With much discussion the group produced the following exception statement. Chan moved to adopt this exception to 802 functional requirements subject to confirmation of the working group, and that any proposed changes to these exceptions be submitted in writing. Bruce seconds. Carried 9 - 0 - 1.

"Compatibility

a) Functional requirements

The proposed standard will meet all of the 802 Functional requirements, except that the probability that a MAC Service Data Unit (MSDU) reported at the MAC service interface contains an undetected error, due to operation of the conveying MAC and Physical Layer entities, shall be less than 5×10^{-14} per octet of MSDU length and the MSDU loss rate will be less than 4×10^{-5} for MSDU length of 512 octets, in a minimally compliant network:

- 1) when the radio terminal is within the defined radio service area,
- 2) for all but 0.1 % of the locations, due to time-invariant fading, and
- 3) for all but 0.1% of the time in other locations due to short time-variant fading.

NOTE: These outages are an inescapable consequence of using media subject to fading. Moving 7 cm (3") or less will move out of the time-invariant fade. The protocol will make provisions for automatic repeat request (ARQ), path diversity, antenna diversity, distribution systems, and/or forward error correction so that a fully compliant network will meet all 802 Functional requirements (at an above the MAC layer) without exception.

Positions and arguments:

P* That the 10^{-8} BER be removed

A+ The network performance requirements can be defined at the LLC/MAC interface, for MAC MSDUs. 802.11 may achieve the performance requirements using new expectations of what can be provided at the MAC/PHY interface. The detected bit error rate at the MAC/PHY interface may exceed 8×10^{-8} per octet with no harm - assuming for instance that forward error correcting codes or automatic retry request is implemented in the MAC.

P The MSDU loss rate will be less than 4×10^{-5} for MSDU length of 512 octets.

A+ Undetected error rate at the LLC/MAC interface is not a complete characterization, it represents the effect of the 10^{-9} undetected BER at the MAC/PHY interface. Frame loss rate must represent the 10^{-8} detected BER at the MAC/PHY expected with other MAC protocols. If the detected octet BER is 8×10^{-8} , and an MSDU is 512 octets long, then the probability of frame loss is $1 - (1 - 8 \times 10^{-8})^{512}$, or 4×10^{-5} . This frame loss rate varies with MSDU length, long MSDUs are more likely to be lost.

P in a minimally compliant network

A+ Allows definition of standard features that will allow enhanced performance networks that are also compliant

- P add new item 1, defined service area
- A+ Defines that the impaired performance occurs within the area of claimed coverage.
- P remove statement about protocol fix from old item two, new item 3.
- A+ Not a logically meaningful statement, if fixed, it is not broke.
- P additions to the note, possible features for full compliance.
- A+ Some users can not tolerate impaired performance, this allows creation of arbitrarily good (and expensive) networks to meet their needs.
- A- The list provided may not be necessary or sufficient.
- A- ARQ is redundant since LLC 2 provides retry, why add the complexity
- A+ Because MSDU length is not controlled, segmenting MSDUs into short MPDUs with ARQ will improve throughput. (Since the probability of MPDU loss is dependent on MPDU length there is an optimal MPDU length for a given channel error performance characteristic. LLC 2 retry cannot be easily optimized for the channel characteristics.)
- A- ARQ is detrimental in some real time environments. (The old wine new milk problem.)

The ad hoc meeting adjourned.

Draft PAR for 802.11

O/12

5. Project title1 **Wireless Medium Access Control and Physical Layer specification**6. Scope of proposed standard

- 2 To develop a Medium Access Control (MAC) and Physical Layer (PHY) specification for wireless connectivity suitable for fixed, portable and slow-speed mobile use within a local area.
- 3 The goal is that the MAC supports PHYs for any Electro-magnetic wave (i.e. radio waves as well as infra-red or visible light within the MAC.
- 4 Priority will be given to the PHY with the highest support.
- 5 The standard shall support mobile terminals with speed sup to or equal to 8 km/h (5 mile/h). The goal is to be able to support mobile terminals at speeds up to 50 km/h (30 mile/h) to accommodate terminals on fork lifts, etc.
- 6 Because the dynamic range of wireless systems it is almost certain that the local area is limited to an order of magnitude as small as 400 - 1000 m**2 and that a distribution system is almost certainly required to extent the coverage area of the overall network.
- 7 The PHY Layer for Radio waves shall have a frequency band, power output and modulation scheme that makes unlicensed operation of the equipment possible. As frequency spectrum is a precious resource, selection of a completely free band seems impossible.
- 8 Currently the only available spectrum is in the ISM bands on USA territory, probably also allowed in Canada shortly.
- 9 However, these band are crowded and it is felt that some service degradation could be anticipated. Therefore, liaison with regulatory bodies shall strive for regulation in such a way, that all permitted users*) in the band shall be permitted to radiate an equal amount of limited power, shall recognize each other and shall share to band in time.
- 10 *) users include both users supporting the services defined by this standard as well as users providing other services obeying this standard only for co-existence in the band.
- 11 The goal is to obtain worldwide compatible bands and rules for sharing the frequency space.
- 12 Pending available of such band(s) work will consider the ISM bands.
- 13 Supported environments include:
 - in buildings such as offices, financial institutions, shops, malls, small and large industry, hospitals,
 - outdoor areas such as parking lots, campuses, building complexes and outdoor plants and storages.
- 14 NOTE: Cost reasons may force the definition of classes of PHYs for environments with benign or hostile characteristics.
- 15 The Wireless MAC shall support both connectionless service as defined in the MAC definition at speeds between

September 12, 1990

Page 1

Draft PAR for 802.11

O/12

16 1 and 20 Mbit/s as well as a service supporting packetized voice.

17 The specification shall meet the following standards:

- the IEEE P802 Functional Requirements except that
 - * Error rate proviso
 - * transmissions of one node do not necessarily have to be received by all other nodes simultaneously.
- the MAC service Definition IEEE 802.2x/ISO 1003x,
- IEEE 802.1 D for T and SRT bridges, A for....., B for
- 802.10 SDE.

18 The MAC design shall anticipate restrictions on low-frequency pulsing of Electro-magnetic fields due to biological hazards. This will require a transmitter on-off rate to be either irregular or a few hundred Hz or greater under all conditions.

7. Purpose of proposed standard

19 To provide wireless connectivity to automatic machinery, stations that require rapid deployment, which are portable, or hand-held or which are mounted on moving vehicles within a local area.

20 To obtain a vehicle for regulatory bodies to control the shared use of one or more radio frequency bands.

21 NOTE: To make this purpose feasible, this PAR also authorises IEEE P802 to petition or provide comments to regulatory bodies worldwide (e.g. the FCC in the USA, the Department of Communications in Canada, the RF agency of the Department of Trade and Industry in the UK and the Radio Frequency Commission of the CEPT in Europe)

10 Target completion

Architecture definition available:	March 1991
First draft standard ready for ballot in 802.11	Nov 1991
First draft conf standard ready for ballot in .11	March 1992
TCCC ballot of MAC & PHY standard	July 1992
TCCC ballot for conf standard	Nov 1992
Submission to ISO of MAC & PHY standard	Jan 1993

11 Proposed Coordination

CCIR Interim Working Party	
trusted with q AM/9	draft circulation
CEPT/RFC/FM	draft circulation
ETSI	corresp/common membership
ECMA	corresp/particip
Worldwide Regulatory bodies	correspondence
ISA SC-72	Common membership

September 12, 1990

Page 2

Draft PAR for 802.11

O/12

IEEE Vehicular Technology Society
SCC10
ANSI X3S3
IEC/TC83
ISO/IEC JTC1/SC6/WG1
TCMM/MSC

Liaison

Liaison

Liaison

Circulation of drafts

September 12, 1990

Page 3

IEEE 802.11-1
1.42

I: 802.11 Scope provide LAN service
for wire



Movable Portable Moving Stationary
SINGLE CHANNEL SERVICE

SMALL OFFICE

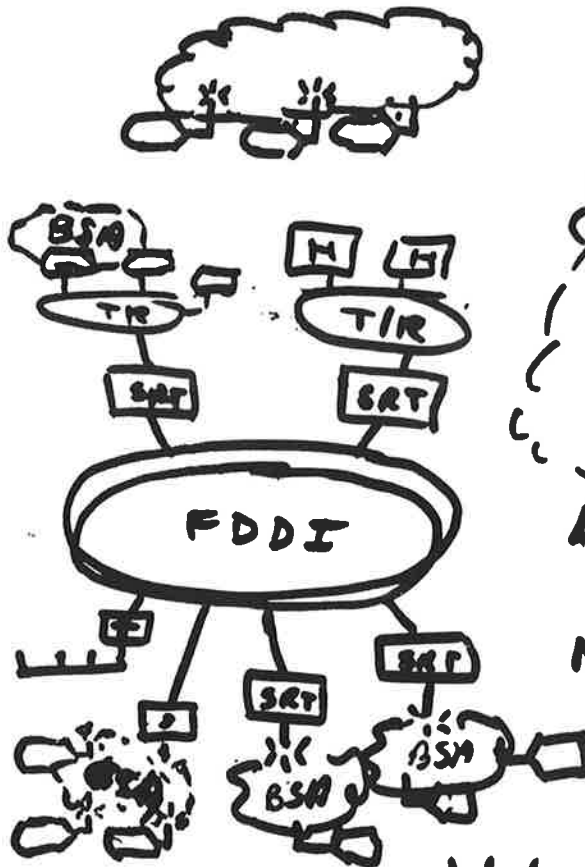

OVERLAPPING LAN

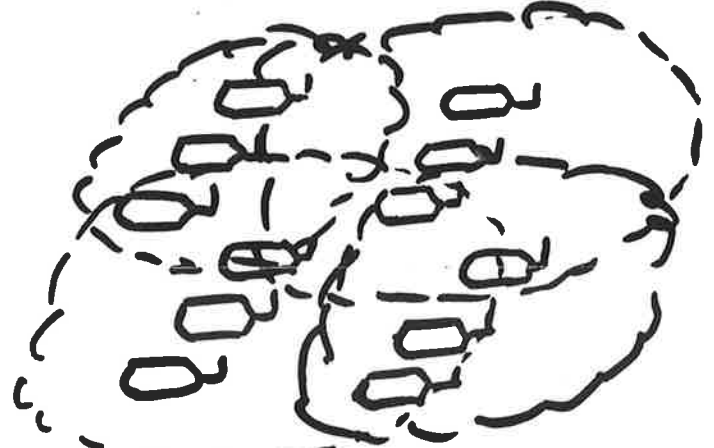

LARGE MALL
UP TO 12 LANS
MAY OVERLAP

James E. Neeley
Advisory Systems Analyst
LAN System Design and RAS
Communications Systems

International Business Machines Corpora
P.O. Box 12195
Dept. H89, Bldg. 002
Research Triangle Park, NC 27709
919 583 3259

IBM

Heterogeneous Multi-LAN

IEEE 802.11/0-13
2.43

I: Extended Service Area LAN

- Large Office
- Factory
- Airport
- University Campus



IBM

James E. Neeley
Advisory Systems Analyst
LAN System Design and RAS
Communications Systems

International Business Machines Corporation
P.O. Box 12195
Dept. H89, Bldg. 002
Research Triangle Park, NC 27709
919 543 3259

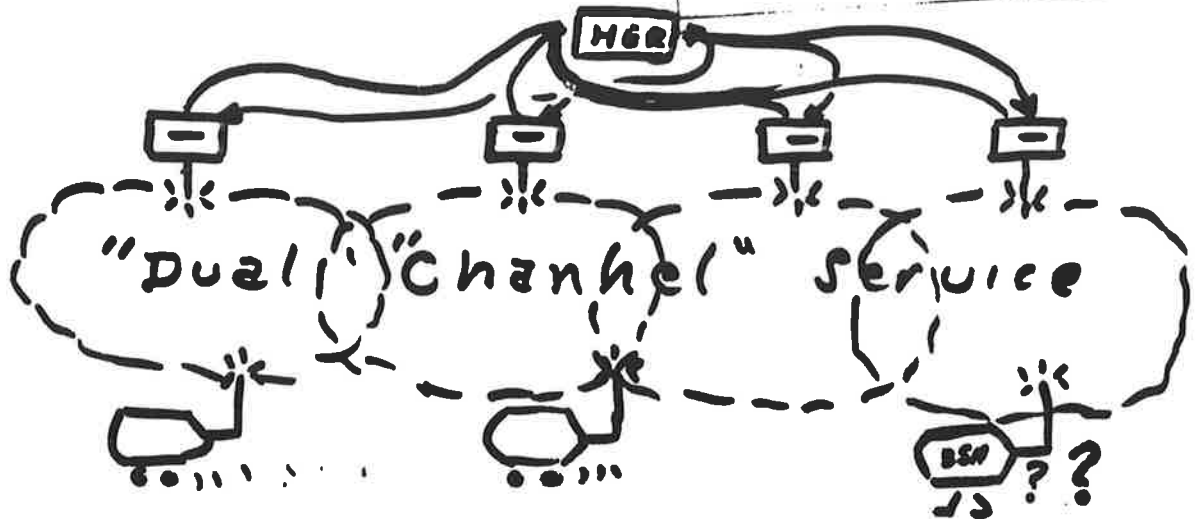

Distribution system will implement

- DS stations (addressable HE) transparent to users.

- eg. - all stations ~~between~~ between Ch1
- seamless transfer between base areas (between frames)

- Mechanism for automatic ESA shift
eg - hear DS heartbeat - send on designated Reverse "Up" channel
- no heartbeat - send on "Dn" channel

Integrate SRT, Server in? DS on
Cooperate unit

I: Model

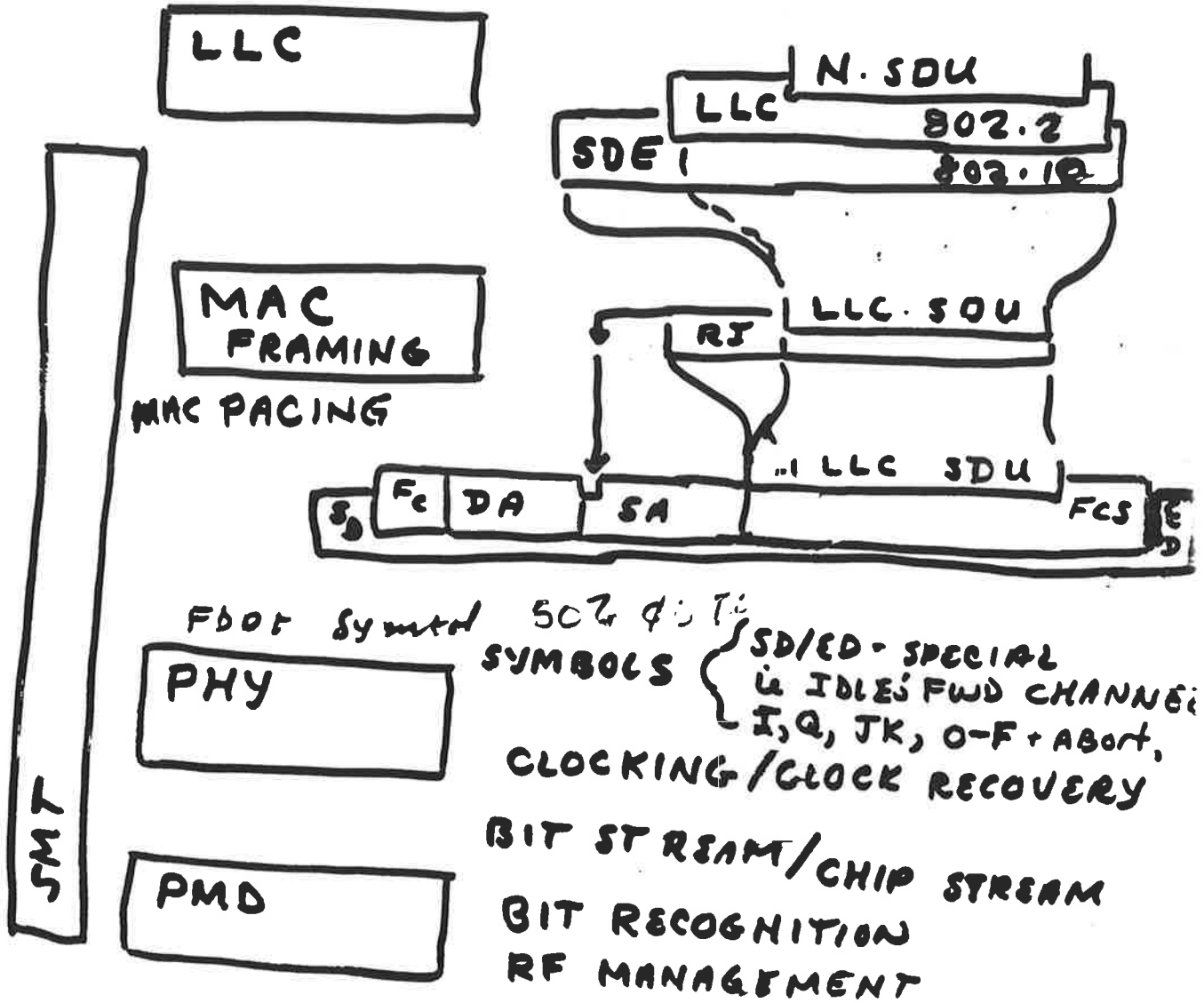

Stations

- | | |
|----------|---|
| User | MAC - PMD - PHY - MAC - LLC |
| Server | PMD - PHY } MAC } SUC |
| Bridge | PMD - PHY } LLC } PHY - PMD |
| Repeater | [PHY - PMD
PHY - PMD] |

FDDI Architecture

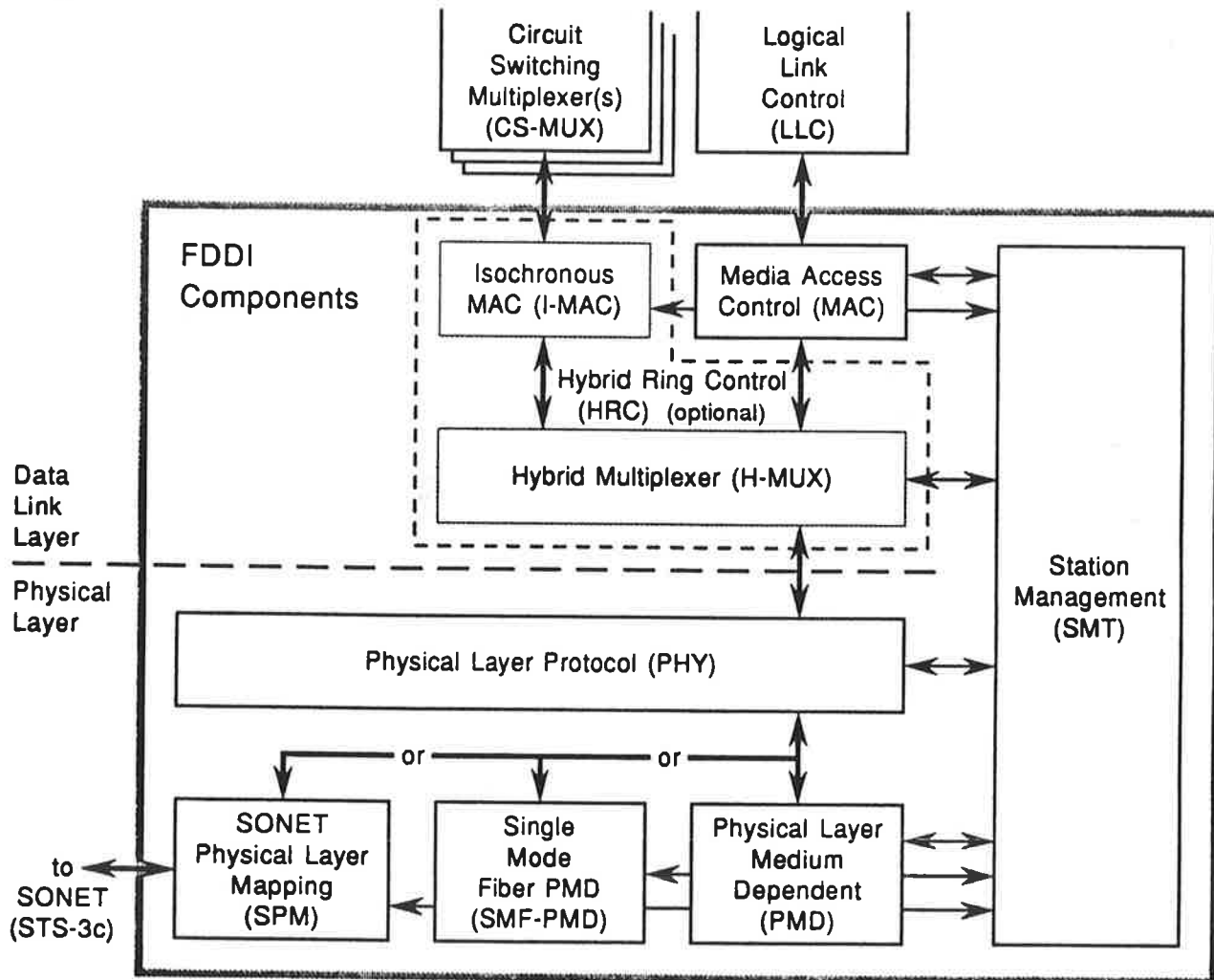

FDDI Follow-on Project Proposals

(initial phase)

Physical Layer Medium Dependent (PMD)

- **Private fiber-optic data links**
- **Single and multi-mode fiber**
- **Signalling rate significantly higher than FDDI**
- **Use FDDI-compatible cable plant where feasible**

Physical Layer Protocol (PHY)

- **Signalling via PMD and SONET links**
- **Scalable from STS-3 to at least STS-48 data rates**

Service Multiplexer (SMUX)

- **Multiplex isochronous and asynchronous data**
- **Efficient use of PHY links**
- **Support both open and closed loop topologies**
- **Scalable from STS-3 to at least STS-48 data rates**

FDDI Follow-on Topology

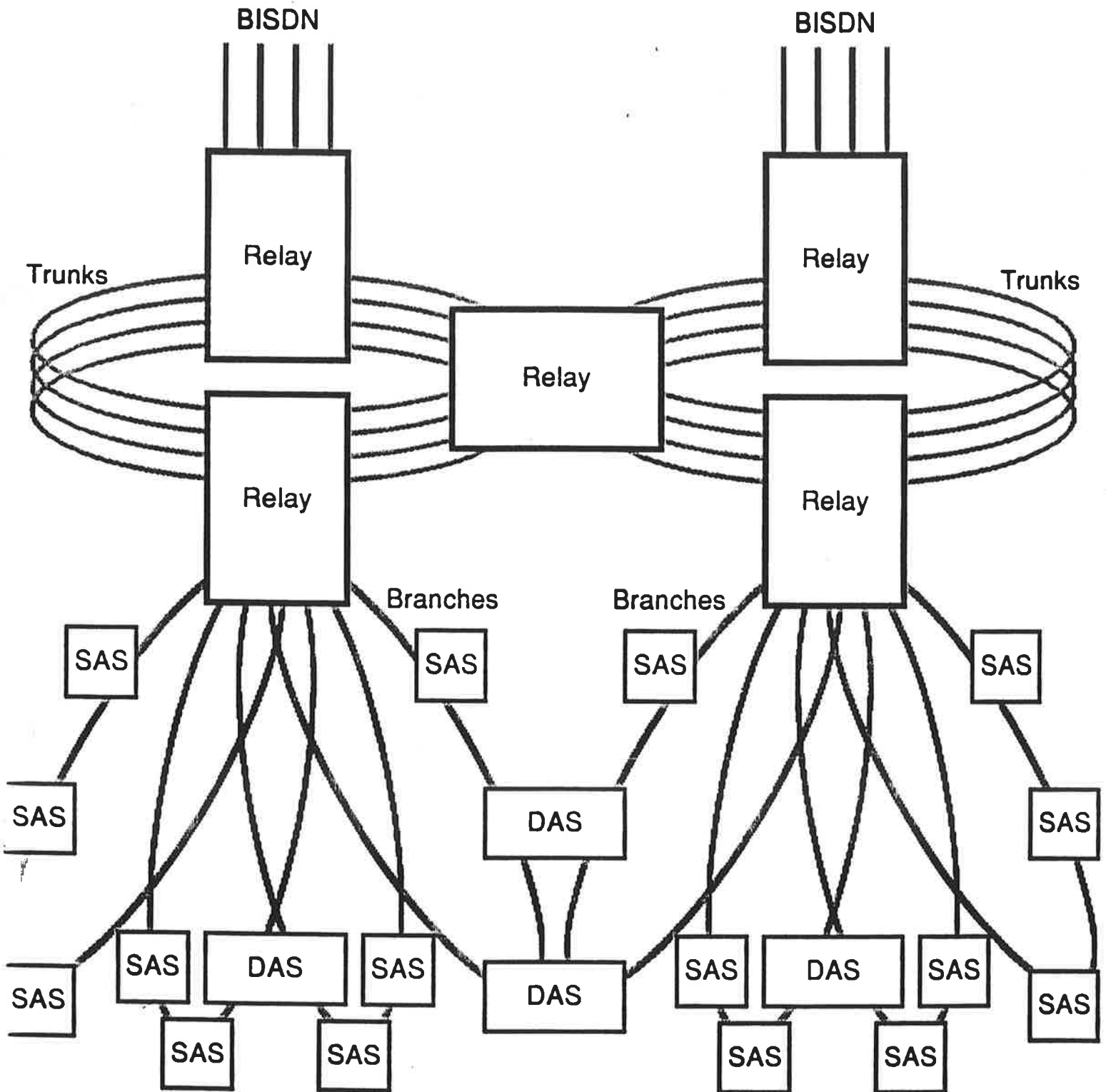

Trunks and branches may be mixture of open and closed loops.

FDDI Follow-on Architecture

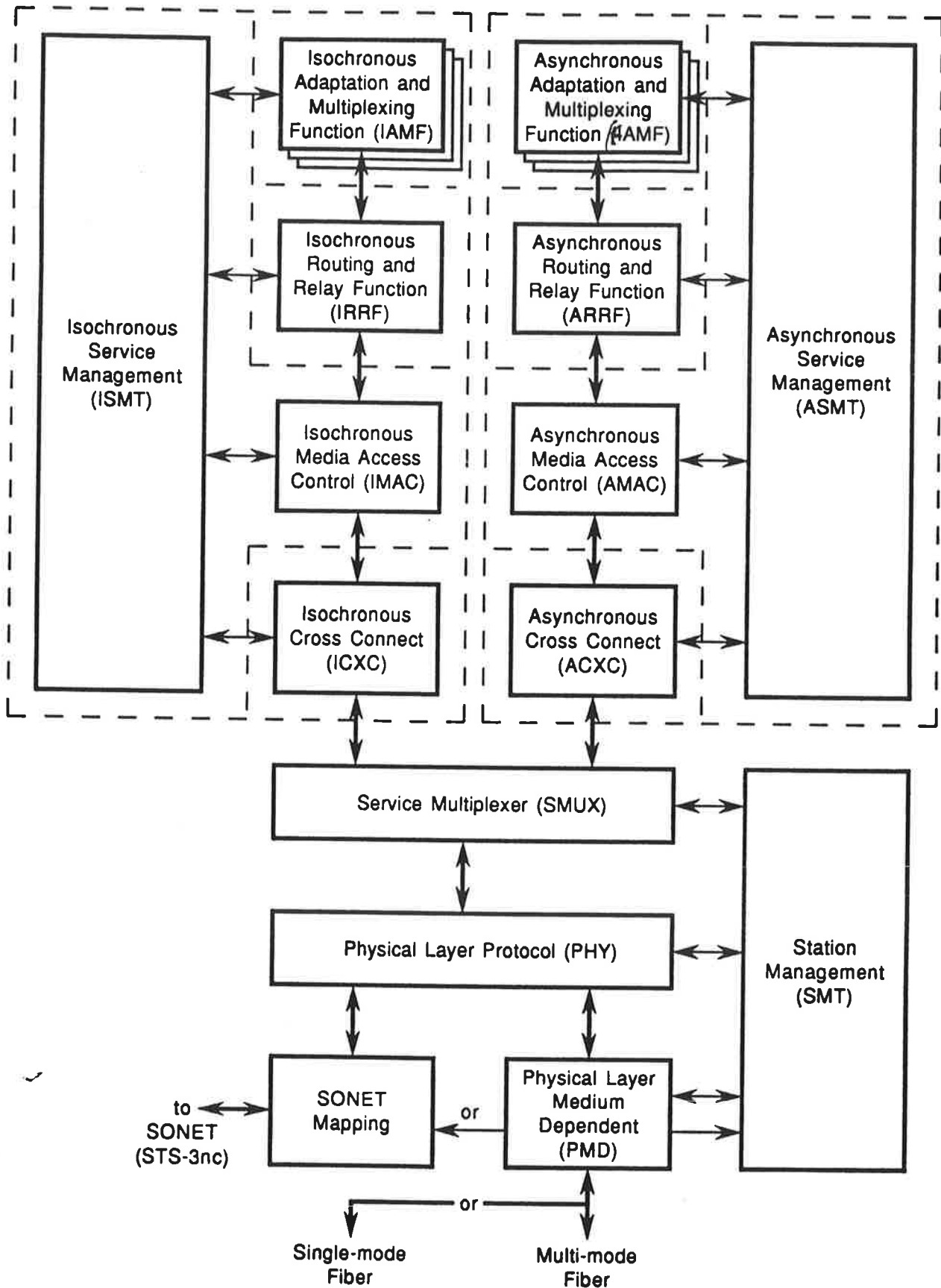

Market of interest

Office market

Retail market

Financial institutions

**Requirements of marketplace
on architecture**

- | | |
|--------|--|
| Retail | 1 robustness |
| | 2 cover large area |
| Office | 3 simple (plug & play), especially for BSA |
| | 4 subset: migrate facility wide area system from BSA to ESA |
| | 5 bridging facility (to bridge LANs that require E-M cohabitation) |
| | 6 co-existence of separated LANs |
| | 7 wireless building-to-building links |
| ESA) | 8 facility wide station mobility (multiple BSA and |

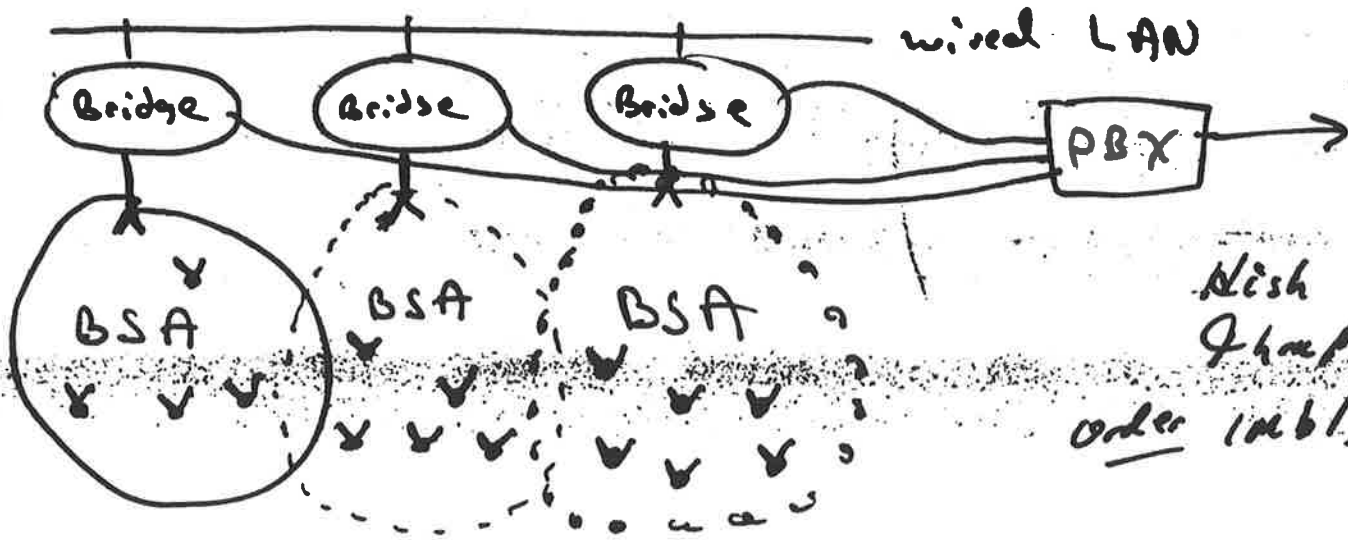

Wish
 of hopnet
 order 10mb/s



separate
 LAN units
 electromagnetic
 cohabitation
 needed.

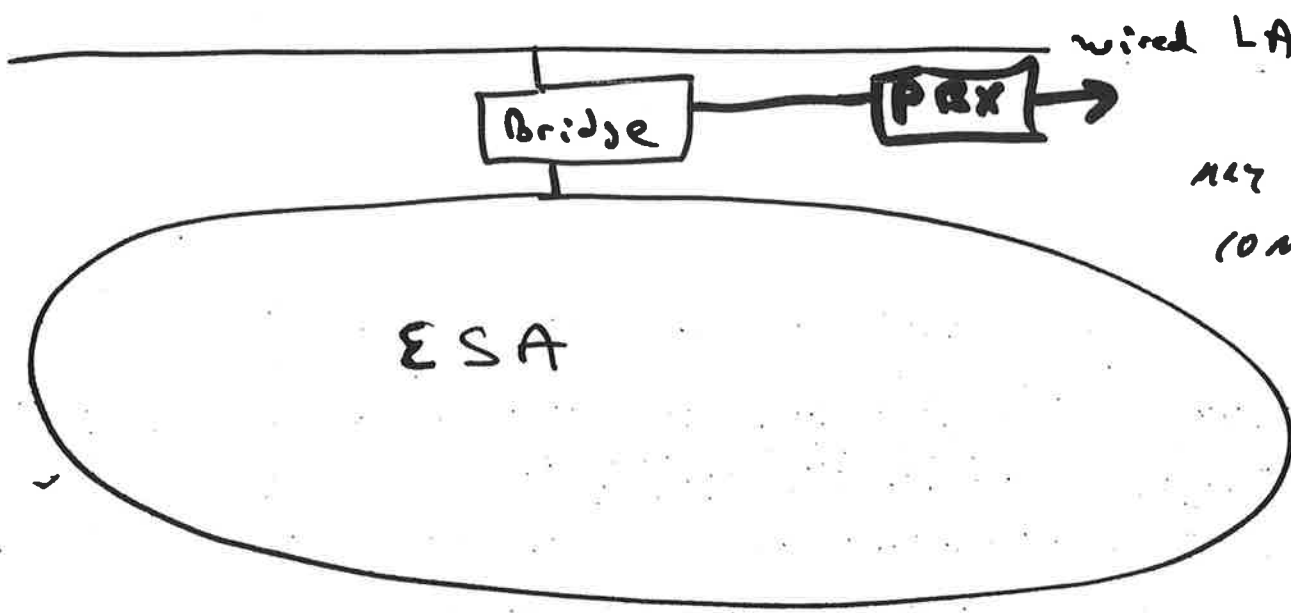

100 run
 10mb/s

market requirements:

Customers - many and varied, really defined by usage areas.
 Due to perceived bandwidth limitations, primary interest is in
 supplementing wired lan, not replacement.
 Seen as existing in same facilities as wired lans.
 Many building where wires can not be run for whatever reason.
 Most interest in office environments
 Need two types of coverage:

- a) Point to point coverage
 - Inherent radio unit range.
- b) Extended field coverage
 - Via a "distribution system"
 - Dist sys needs to be wireless itself.
 - Movement within extended field to be transparent to user.

No end user license mandatory.

General requirements:

Station end hdw to be used for both a) and b) above
 Don't obsolete hdw investment when upgrade system.
 Sensitive to hdw price
 Higher price for industrial enviro hdw ok,
 Should interoperate with consumer hdw.
 Sensitive to power consumption
 - no active idle states.
 Interoperability / common protocols highly desired
 People use PC for many things.
 Installation ease important
 No unique hdw addresses etc. that have to be
 coordinated - too difficult.
 Easy field strength determination.
 Robust
 Failure modes:
 graceful performance degradation
 over crash and burn
 No centralized vulnerable points
 Problem Diagnosis hooks desirable
 More than one WLAN must be able to exist
 in same facility.
 General issues:
 people talk about bandwidth, I'm more
 interested in impact of design on throughput.

Device	Market	Requirement/comment	sales/yr
SS	tationary	BSA, ESA, Net Mgmt, Locating lights green/red	
PP	Portable	ESA, Access mgmt - access denial if unknown, Assett mgmt - burned in device ID	
MI	Moving indoor	ESA, device tracking - locating ????	700
MO	Moving outdoors	ESA-outdoor vehicle recognition near gate	10000/day
	Small Office	80% open area/no walls to hide wire RQ: BSA. plug and play, no LAN mgmt	x,x00,000
	Large office	30% office workers move annually 50% hi-tech office workers move annually Temporary office locations wired services sometimes inadequate	x,000,000%
SS PP MI	Retail mall - anchor store	many BSA overlapping - easy setup ESA per floor, linked - high level met mgmt	x00,000 xx0,000
SS PP	- fast food	untethered order takers indoor/outdoor Rq: hand motion ESA	x0,000
	Education k-12	SS - BSA for student PC room	x,000,000
	university	SS PP ESA for lecture hall, library, dorm outdoor campus coverage multiple ESA with fiber backbone	xx.000000
	Transportation		
	yard trucks	ESA-outdoor	
	airline	ESA- airport utility for multiple users airlines - curb, ticketing, gate, loading auto rental - mult terms, busses. yard, etc.	
	insurance/finance	ESA w/ packet remote bridge	

General REQUIREMENTS

Bridging support for both SR and TB protocols conforming to SRT.



James E. Neeley
Advisory Systems Analyst
LAN System Design and RAS
Communications Systems

International Business Machines Corporation
P.O. Box 12195
Dept. H89, Bldg. 002
Research Triangle Park, NC 27709
919 543 3259



MARKETS ADDRESSED: 100% COVERAGE.

STATIONARY, PEDESTRIAN, SLOW VEHICULAR < 20 MPH (ANALYSIS NOT COMPLETE FOR MOVING VEHICLES), SMALL THROUGH HUGE AREA, INCLUDING SOME REAL TIME VOICE/DATA CHANNELS. HIGH DELAY SPREAD & LOW ATTENUATION & HIGH IMPULSE NOISE ENVIRONMENTS. INCLUDE LIGHT THROUGH HEAVY INDUSTRIAL (IE HIGH NOISE THROUGH HIGH SPREAD)

CONSTRAINTS IMPOSED:

PEDESTRIAN & VEHICULAR REQUIRE ANTENNA DIVERSITY ON BOTH TX & RX PATH FOR 100% COVERAGE. HIGH DELAY SPREAD REQUIRES SPREAD SPECTRUM FOR 100% COVERAGE.

HUGE AREA REQUIRES OPTIMIZATION FOR DISTRIBUTION. IMPULSE NOISE REQUIRES ARQ.

HEAVY INDUSTRY REQUIRES LOW ANTENNA TO AREA DENSITY (1 PER 225 m² - 1 PER 1000 m²)

REAL TIME VOICE DATA REQUIRE SYNCHRONIZING HEAD END (OR PRIORITIZING)

LARGE WIRING COST REQUIRE 1 DISTRIBUTION SYSTEM FOR MULTIPLE SERVICES

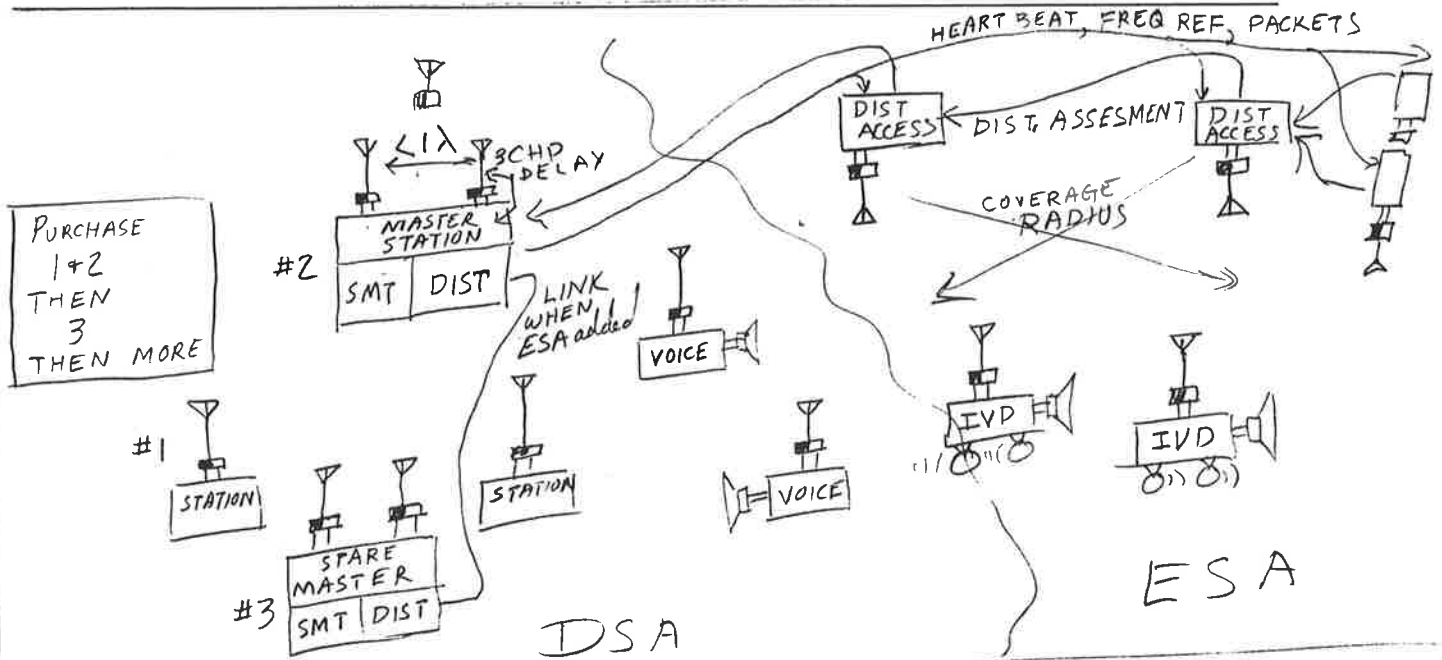

MASTER STATION CYCLE

